

*Pioneer Dj*

DJ SAMPLER

# DJS-1000

[pioneerdj.com/support/](http://pioneerdj.com/support/)

For FAQs and other support information for this product, visit the above site.

Operating Instructions

---

---

# Contents

## How to read this manual

- Thank you for purchasing this Pioneer DJ product. Be sure to read this manual and the “Operating Instructions (Quick Start Guide)” included with the unit. Both documents include important information that you should understand before using this product.
- In this manual, buttons, terminals, names of screens and menus displayed on the product and computer screen, etc., are enclosed in square brackets ([ ]). (e.g.: [CUE] button, [Files] panel, [MIC1] terminal)
- Screens, external appearance, and software and hardware specifications described in this manual are based on the product that is still under development and may differ from the final specifications.
- Depending on your operating system, the web browser settings, etc., the procedures described in this manual may differ from actual operations.

## 01 Before start

Features .....	3
Accessories .....	3
Supported media .....	3

## 02 Connections and part names

Connections .....	4
Part names and functions .....	6

## 03 Project structure

### 04 Basic operation

Starting the system .....	10
Loading a project .....	10
Playing and stopping a pattern .....	10
Adjusting the playing speed (Tempo Control) .....	10
Switching the pattern .....	11
Switching the scene .....	11
Changing the length of a pattern .....	11
Loading a sample to a track .....	11
Using the performance pads .....	12
Using the step keys parameter adjustment knobs .....	13
Using the touch strip function .....	13
Saving a project .....	14
Turning off the system .....	14

### 05 Advanced operation

Making overall settings, adjustments, and checks (HOME) .....	15
Track display content .....	16
Managing project files (PROJECT) .....	16
Adjusting the volume of each track (MIXER) .....	18
Checking sequences (SEQ.) .....	18
Setting BPM (BPM) .....	19
Setting quantize (QUANTIZE) .....	19
Setting synchronization with externally connected device (SYNC) .....	20
Managing scenes and patterns (SCENE MANAGER) .....	21
Audio rendering (RENDER AUDIO) .....	25
Sampling (LIVE SAMPLING) .....	25
Using effects .....	26

### 06 Adjusting track parameters (TRACK MENU)

Setting the track attributes .....	28
Selecting a module .....	28
Setting bypass .....	28
Sample track .....	29
Through track .....	43
MIDI tracks .....	43
TORAIZ AS-1 tracks .....	46

### 07 Changing the settings (UTILITY)

Setting preferences .....	47
Setting the USER mode of the touch strip (TOUCH STRIP SETTING) .....	49
Auto standby function .....	50
Adjusting the touch panel (TOUCH PANEL CALIBRATION) .....	51

### 08 MIDI implementation chart

Connections .....	52
Notes .....	52
Control changes .....	53
Pitch bend .....	54
Mode message .....	54

### 09 Additional information

Troubleshooting .....	55
Liquid crystal display .....	55
Cleaning the touch display .....	55
Signal flow .....	56
Trademarks and registered trademarks .....	56
Cautions on copyrights .....	56

# Before start

## Features

This unit is a standalone hardware sampler and sequencer for DJs that enables intuitive performances. It functions as a new kind of musical instrument that can also be used for DJ performances and live performances and is equipped with a user interface providing high operability and numerous performance functions, so a wide range of musical expression is possible on stage.

## Step sequencer

Large multicolored step input keys that can be tapped while looking at the sequence information on each track and the track colors are provided to allow you to easily create a new groove.

## Large performance pads

The unit is equipped with large rubber pads that increase or decrease the volume depending on the strength with which they are tapped by employing highly accurate velocity detection. Each pad has built-in multi-color illumination so you can instantaneously understand the information required for your performance from the color and lighting state of the pad.

## Real-time processing engine

A time stretch engine that runs for all 16 tracks in real-time, an amplifier envelope, effects, etc. are available, and samples can be assigned to tracks to suit applications such as loop, one shot, and SFX (effect sounds) and can be easily synchronized with the sequencer and played with high sound quality.

## 7-inch touch display

The display unit is equipped with a full-color LCD touch display. It displays the information required for performances in an easy to understand manner, such as the HOME screen to view the information on the sample sound source assigned to each track that uses instrument icons and color representations linked to the pads and the SEQUENCE screen to understand the sequencer performance status.

## Functions to synchronize performances with external devices

This unit is of course capable of clock synchronization with MIDI-compliant devices, but it also has the BEAT SYNC function which can synchronize a performance with the track being played by a PRO DJ LINK-compatible Pioneer DJ multi player such as the CDJ-2000NXS2. Furthermore, performances can be synchronized with any equipment manually if you use the tempo slider, which allows you to control the tempo just like with DJ equipment, and the NUDGE button.

- Operates with compatible DJ systems when playing tracks whose beats have been analyzed by rekordbox™.

## LIVE SAMPLING

The LIVE SAMPLING function is provided to enable the sounds input to the unit to be sampled with a simple operation so that they can be used as tracks. Since the sampled sounds are automatically synchronized with sequences to play in a loop, they can be used immediately for remix performances.

## Other features

### ❖ FX

- An audio effect that enables dynamically changing any track tone with a simple operation is available.

### ❖ Touch strip

- In addition to the pitch bend and note repeat functions, the "touch strip" function, which allows you to customize operation parameters, is supported

### ❖ Support for USB storage devices

- There is support for USB storage devices which are useful for managing sound sources and projects.

### ❖ Preset sound sources

- Samples (from Loopmasters) that allow you to start performing right away out of the box are available.

## Accessories

- Power cord
- USB cable
- LAN cable
- RCA pin cable
- Warranty (for some regions)<sup>[1]</sup>
- Operating Instructions (Quick Start Guide)

[1] The warranty is included for European region only.

— For the Japanese region, the corresponding information is provided on the back cover of the "Operating Instructions (Quick Start Guide)".

— For the North American region, the corresponding information is provided on the last page of both the English and French versions of the "Operating Instructions (Quick Start Guide)".

## Supported media

This unit is compatible with USB mass storage class devices such as USB flash drives and digital audio players.

File systems	FAT, FAT32 and HFS+
<ul style="list-style-type: none"> <li>• Samples (wav and aiff with a sampling frequency of 44.1 kHz) on a USB device can be used with this unit.</li> <li>• Depending on the USB device you are using, you may not achieve the expected performance.</li> <li>• There is no guarantee that all USB devices will operate with this unit.</li> </ul>	

---

---

# Connections and part names

---

---

## Connections

Turn off this unit and disconnect the power cord from the power outlet before connecting components or changing the connections.

Connect the power cord to a power outlet after all the connections are completed.

Be sure to use the power cord, USB cable, and LAN cable included with this product.

Refer to the operating instructions for the components to be connected.

- When using a LAN cable to connect the components, be sure to use either the LAN cable included with this product or an STP (shielded twisted pair) cable.
- Do not disconnect the LAN cable when information is being shared with PRO DJ LINK.
- A switching hub (commercially available) may be necessary depending on the models to be combined. Use a switching hub of 100 Mbps or greater. Correct operation may not be possible depending on the switching hub.
- A switching hub (commercially available) is necessary when connecting with a mixer that has only one LAN port. In the case of a mixer with enough LAN ports for all the DJ players and computers in the system, connect directly to a LAN port on the mixer's rear panel without using a hub.

---

---

## System expansion

### ❖ When importing samples from a USB device

When a USB device is inserted into the unit, the **[PIONEER DJ SAMPLER]** folder is created automatically. Only samples placed in the **[Samples]** folder in this **[PIONEER DJ SAMPLER]** folder can be read by the BROWSE function (p. 29).

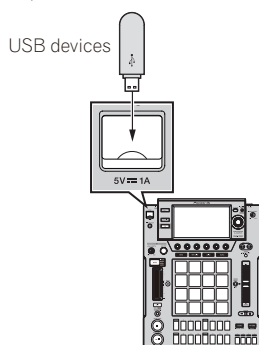

❖ **When using with external devices**

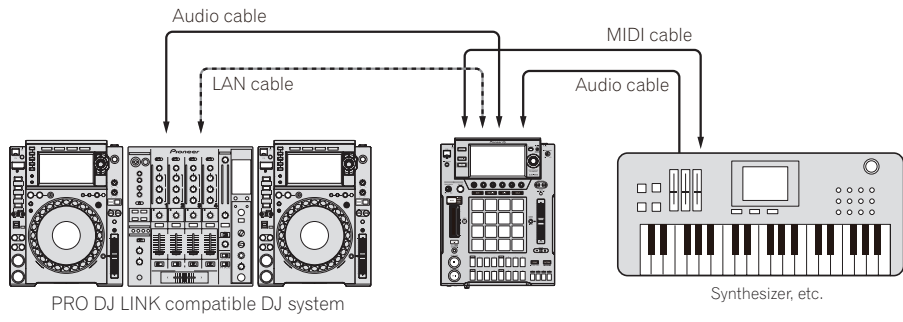

**Connecting to a mixer with one LAN port**

When connecting to a mixer with only one LAN port using a switching hub, set the channel number of the mixer to which the audio or digital audio cable is connected and the player number displayed at the bottom left of the main unit display to the same number.

(Ex.: When an audio cable is connected to channel 1)

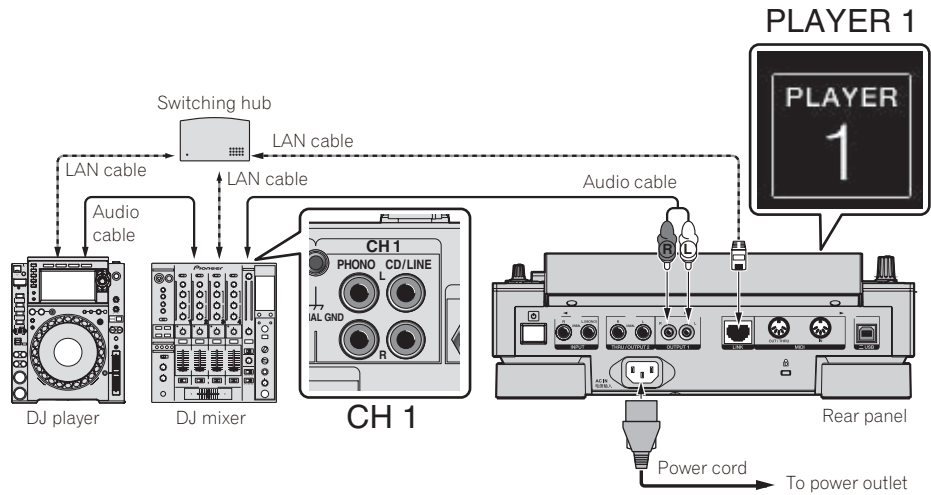

To change the player number, follow the procedure below.

- ① Disconnect the USB device and LAN cable.
- ② Press the **[HOME/UTILITY/WAKE UP]** button for over 1 second to display the **[UTILITY]** screen.
- ③ Turn the rotary selector to select **[PLAYER No.]**, and press the rotary selector.
- ④ Turn the rotary selector to select a player number, and press the rotary selector.
- ⑤ Press the **[HOME/UTILITY/WAKE UP]** button to complete the setting.

# Part names and functions

## Top panel

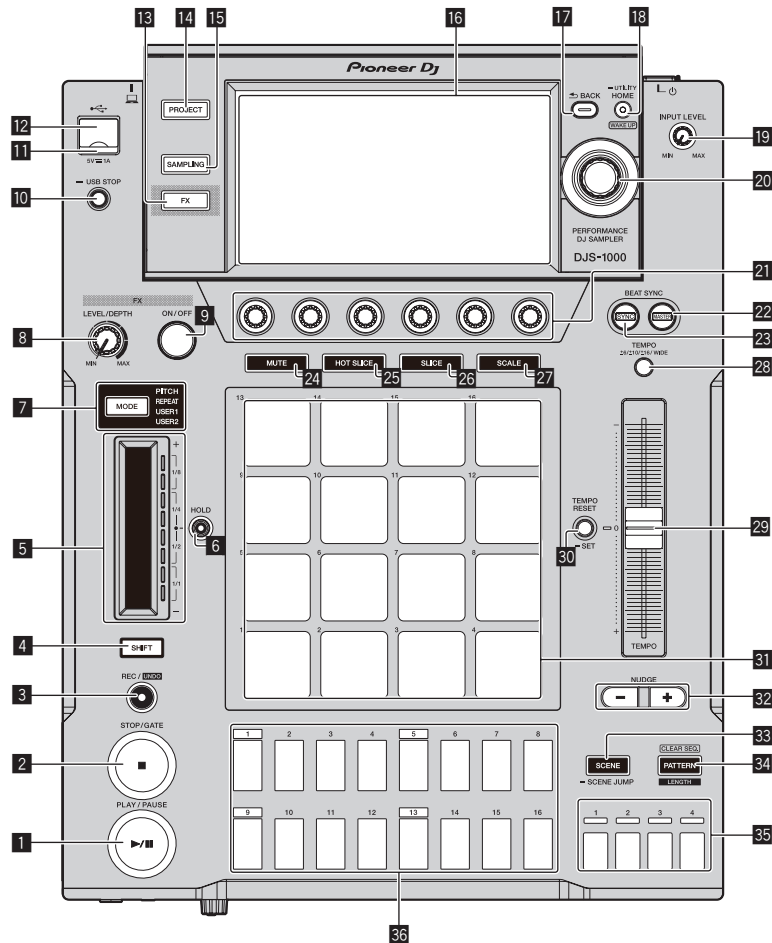

### 1 PLAY/PAUSE ►/|| button

Plays or pauses a pattern. This is lit when playing a pattern and flashes when in the pause mode.

↪ *Playing and stopping a pattern* (p.10)

### 2 STOP/GATE button

Stops a pattern. Pressing the [STOP] button while a pattern is stopped plays the pattern only while the button is pressed.

### 3 REC/UNDO button

Records a pad performance. Pressing the [REC/UNDO] button while pressing the [SHIFT] button returns to the state before recording.

### 4 SHIFT button

Calls out another function if this button is pressed while another button is pressed.

### 5 Touch strip

Adjusts the effect of each mode of the touch strip.

↪ *Using the touch strip function* (p.13)

### 6 HOLD button

Holds the effect of the touch strip.

↪ *Using the touch strip function* (p.13)

### 7 MODE selection button and MODE indicators

The **MODE** indicator displays the selected touch strip mode.

Each press of the **MODE** selection button switches the touch strip mode.

↪ *Using the touch strip function* (p.13)

### 8 FX LEVEL DEPTH control

Adjusts the quantitative parameter of the effect.

### 9 FX ON/OFF button

Turns the effect on/off.

### 10 USB STOP button

Press for at least 2 seconds before disconnecting the USB device.

### 11 USB indicator

Lights up or flashes when this unit is communicating with the USB device.

### 12 USB device insertion slot

Connect a USB device.

### 13 FX button

Displays the PERFORMANCE FX screen on the touch display.

### 14 PROJECT button

Displays the PROJECT screen on the touch display.

### 15 SAMPLING button

Displays the LIVE SAMPLING screen on the touch display.

### 16 Touch display

Displays various information.

### 17 BACK button

The screen returns to the layer above.

**18 HOME/UTILITY/WAKE UP button and STANDBY indicator**

**HOME:** Displays the HOME screen on the touch display.

**UTILITY:** Pressing and holding the [HOME/UTILITY/WAKE UP] button displays the UTILITY screen on the touch display.

**WAKE UP:** Setting **AUTO STANDBY** to ON in the UTILITY screen and then pressing the [HOME/UTILITY/WAKE UP] button cancels the auto standby state.

➔ *Auto standby function* (p.50)

**19 INPUT LEVEL control**

Adjusts the level of sound input to the [INPUT] terminals.

**20 Rotary selector**

Turning the rotary selector when selecting a project, track, setting item, etc. moves the focus. Pressing the rotary selector selects the focused item.

**21 Parameter adjustment knobs**

Adjusts the parameters assigned to each parameter adjustment knob.

The leftmost parameter adjustment knob is the parameter 1 adjustment knob, and the knobs are arranged from the left in order of the parameter 1 adjustment knob to parameter 6 adjustment knob.

➔ *Using the step keys parameter adjustment knobs* (p.13)

**22 BEAT SYNC MASTER button**

Sets this unit as the master for the beat sync function.

➔ *Setting synchronization with externally connected device (SYNC)* (p. 20)

**23 BEAT SYNC button**

Turns the beat sync function on.

➔ *Setting synchronization with externally connected device (SYNC)* (p. 20)

**24 MUTE button**

Switches the pad mode to the mute function.

➔ *Muting a track (MUTE mode)* (p.12)

**25 HOT SLICE button**

Switches the pad mode to the hot slice performance function.

➔ *Playing a hot slice performance (HOT SLICE mode)* (p. 12)

**26 SLICE button**

Switches the pad mode to the slice performance function.

➔ *Playing a slice performance (SLICE mode)* (p.12)

**27 SCALE button**

Switches the pad mode to the scale performance function.

➔ *Playing a scale performance (SCALE mode)* (p.12)

**28 TEMPO ±6/±10/±16/WIDE button**

Switches the playing speed adjustment range (±6/±10/±16/WIDE).

**29 TEMPO slider**

Adjusts the playing speed of tracks.

**30 TEMPO RESET/SET button and TEMPO RESET indicator**

Plays the pattern using the BPM value set for the project regardless of the position of the TEMPO slider.

- Pressing and holding the [TEMPO RESET/SET] button sets the currently playing BPM as the BPM of the project.

**31 Performance pads**

Use these pads to achieve various performances.

When using with the sample performance function

➔ *Playing a sample sound* (p.12)

When using with the mute function

➔ *Muting a track (MUTE mode)* (p.12)

When using with the hot slice performance function

➔ *Playing a hot slice performance (HOT SLICE mode)* (p. 12)

When using with the slice performance function

➔ *Playing a slice performance (SLICE mode)* (p.12)

When using with the scale performance function

➔ *Playing a scale performance (SCALE mode)* (p.12)

**32 NUDGE button**

Enables the offset from a sample for which a synchronized performance is being performed to be corrected manually by slightly advancing or delaying the BPM of the playing pattern.

**33 SCENE/SCENE JUMP button**

Turns the scene switching mode on or off.

➔ *Switching the scene* (p.11)

**34 PATTERN/LENGTH/CLEAR SEQ. button**

Turns the pattern switching mode on or off.

- Tapping a performance pad while pressing the [PATTERN/LENGTH/CLEAR SEQ.] button clears the corresponding track trigger.

➔ *Switching the pattern* (p.11)

**35 Bar selection keys**

Selects bars to display for the 16 step keys.

**36 16-step keys**

Used for functions such as inputting a programming trigger, scene/pattern switching, step recording, and step modulation.

When using with the pattern switching function

➔ *Switching the pattern* (p.11)

When using with the scene switching function

➔ *Switching the scene* (p.11)

When using with the step recording function

➔ *Programming triggers (step recording)* (p.13)

When using with the step modulation function

➔ *Changing parameters by step (step modulation)* (p.13)

## Rear panel

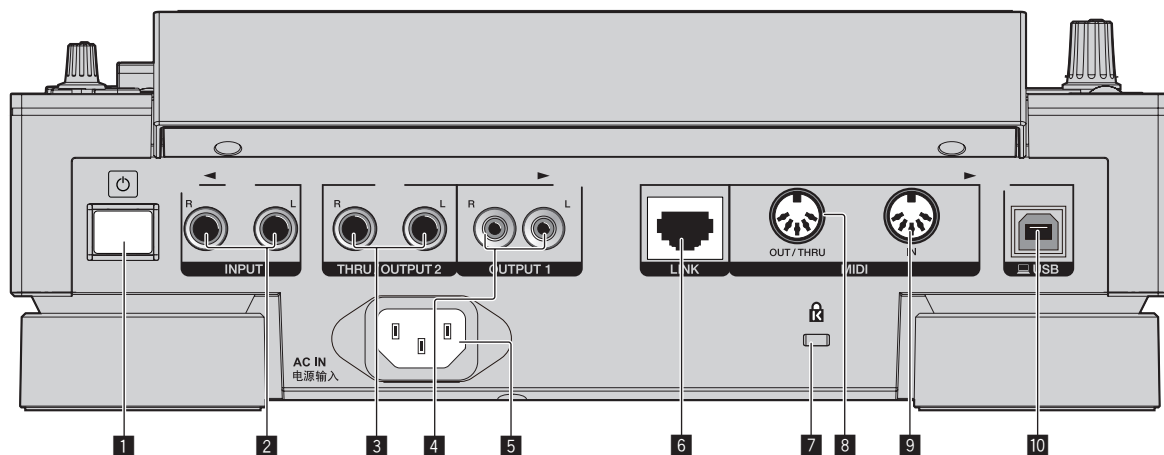

### 1 **⏻ switch**

Turns this unit on and off.

➡ *Starting the system* (p.10)

### 2 **INPUT terminals**

Connect to the output terminals of another mixer or a line level output component. If a cable is connected to the [L] terminal only, the input to the [L] terminal is also input to the [R] channel.

### 3 **THRU/OUTPUT2 terminals**

### 4 **OUTPUT1 terminals**

### 5 **AC IN**

Connect to a power outlet.

- Connect the power cord to a power outlet after all the connections are completed.
- Be sure to use the supplied power cord.

### 6 **LINK terminal**

Connect a PRO DJ LINK compatible device with the LAN cable (included).

### 7 **Kensington security slot**

### 8 **MIDI OUT/THRU terminal**

Connect a MIDI device to this DIN type terminal.

### 9 **MIDI IN terminal**

Connect a MIDI device to this DIN type terminal.

### 10 **USB-B terminal**

Connect to a computer.

- A USB hub cannot be used.
- To maintain the performance, connect this unit and computer directly using a USB cable that conforms to USB 2.0.

## Front panel

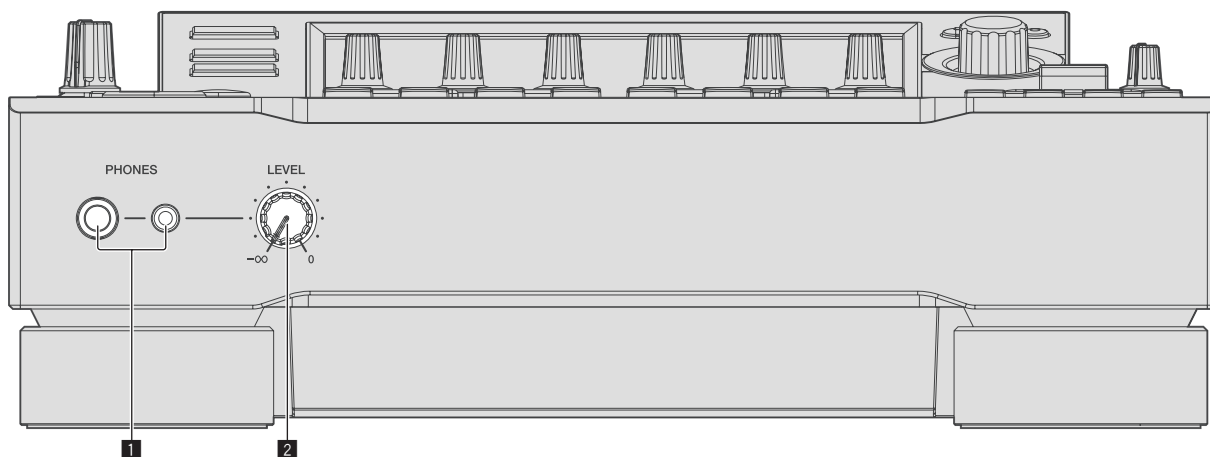

### 1 **PHONES terminals**

Connect headphones. 1/4" stereo phone plugs are supported.

### 2 **LEVEL control**

Adjusts the level of sound output from the headphones.



# Project structure

The figure below shows the data structure of this unit.

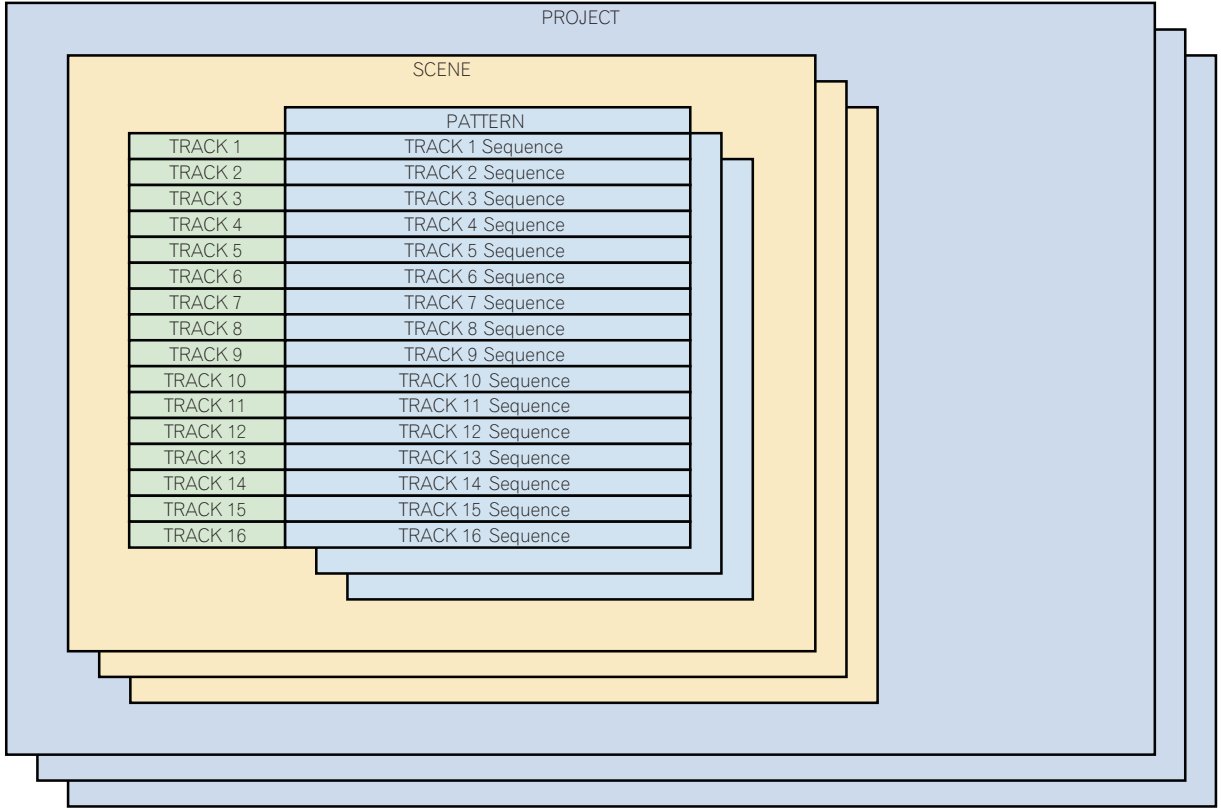

## PROJECT

A project represents one work unit for the user. 16 scenes can be stored in one project.

## SCENE

16 patterns and sample assignment information for tracks are stored in scenes.

Since the samples to assign to tracks can be changed for each scene, the tune can be greatly changed by changing the scene.

## PATTERN

A pattern combines the sequences to create in the 16 tracks and is one finished section of a performance. A pattern length can be set on a step level from a minimum of 1 step to a maximum of 64 steps (4 bars).

## TRACK

Tracks consist of modules such as sample players, amplifier envelopes, insert effects, LFO, sequences, MIDI NOTE, and MIDI CC.

There are the following three track types.

- Sample track: Used when setting a sample in internal memory as the sound source.
- Through track: Used when setting an external input as the sound source.
- MIDI track: Used when performing using an external MIDI sound source.

Sound sources can be assigned as follows: a bass drum to track 1, a snare drum to track 2, and a synthesizer connected to an external input to track 3.

# Basic operation

## Starting the system

1 Plug the power cord into a power outlet after all the connections between devices are completed.

➔ *Connections* (p.4)

2 Press the [⏻] switch on the rear panel of the unit.

The indicators light up and this unit turns on.

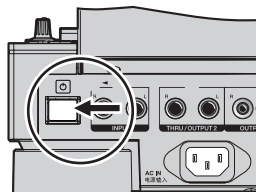

## Connecting a USB device

1 Press the [⏻] switch to turn this unit on.

2 Connect a USB device to the USB device insertion slot.

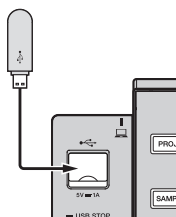

## Disconnecting a USB device

1 Press and hold the [USB STOP] button until the USB indicator turns off.

Do not disconnect the USB device or turn this unit off while the USB indicator is flashing. Failure to do so may result in losing the management data and the USB device becoming unreadable.

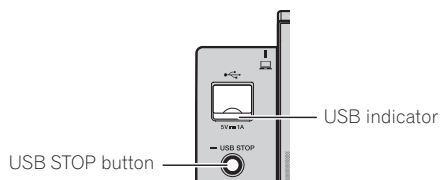

2 Disconnect the USB device.

## Loading a project

Start each procedure in the following sections from the home screen. Press the [HOME] button to display the home screen.

1 Press the [PROJECT] button.

The PROJECT screen appears. You can perform operations such as loading and saving projects on the PROJECT screen.

2 Turn the rotary selector to select [OPEN] and then press the rotary selector.

The media connected to the unit appears.

If you select the media containing the project you wish to use and then press the rotary selector, the project list is displayed.

- Press the [BACK] button to return to the previous screen.

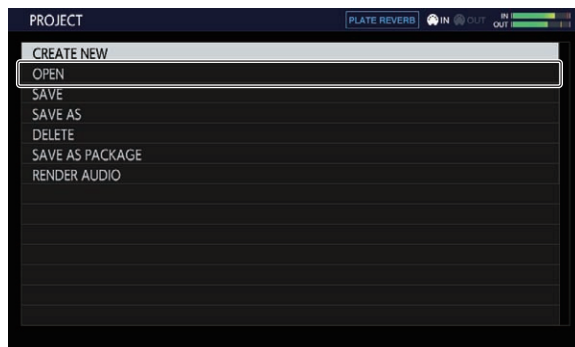

3 Turn the rotary selector to select a demo project and then press the rotary selector.

A confirmation pop-up screen appears.

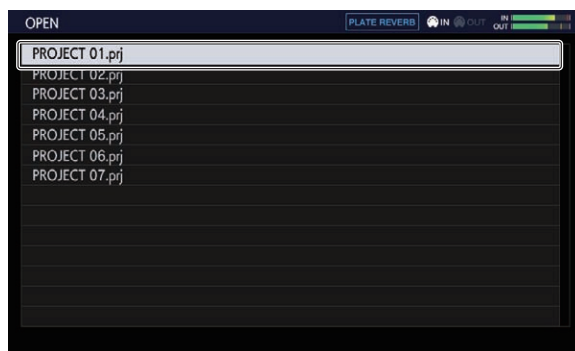

## Playing and stopping a pattern

Press the [PLAY/PAUSE ▶/II] button.

The pattern currently selected for the demo project plays back. During playback, the [PLAY/PAUSE ▶/II] button lights up in green.

- Pressing the [PLAY/PAUSE ▶/II] button during playback pauses playback.
- Pressing the [STOP] button during playback stops playback and returns to the beginning of the pattern.

## Adjusting the playing speed (Tempo Control)

Press the [TEMPO ±6/±10/±16/WIDE] button.

The [TEMPO] slider's adjustment range switches each time the button is pressed. The adjustment range setting is displayed on the screen.

Options	Units of adjustment
±6	0.02 %
±10	0.05 %
±16	0.05 %
WIDE	0.5 %

The [WIDE] adjustment range is ±100 %. When set to -100 %, playback stops.

## Move the [TEMPO] slider forward or backward.

The tempo increases when the slider is moved to the [+ ] side (backward), and decreases when the slider is moved to the [- ] side (forward). The rate at which the playing speed is changed is displayed on the playing speed display.

To set the BPM value of the project, refer to *Setting BPM (BPM)* on page 19.

## Switching the pattern

### 1 Press the [PATTERN] button.

The unit enters the pattern switching mode and the [PATTERN] button lights up in white. The 16 step keys are lit in the currently selected scene colors during pattern switching mode.

- 16 patterns can be assigned to each scene. One pattern is assigned to each step key.
- Scenes with recorded sequences are dimly lit, scenes with no sequences recorded are not lit, and currently selected sequences are fully lit.

### 2 Press a 16-step key set with a sequence.

The pattern assigned to the button is played.

- The timing that the pattern is switched is in accordance with the **PATTERN QUANTIZE** setting value set on the QUANTIZE screen.
- The pressed step key flashes while the pattern is switched.
- Press the [PATTERN] button to exit pattern switching mode.

## Switching the scene

### 1 Press the [SCENE] button.

The unit enters the scene switching mode and the [SCENE] button lights up in white. The 16-step keys light up in the color set for the current scene in scene switching mode..

- 16 scenes can be assigned to each project. One scene is assigned to one of the 16 step keys.
- Scenes with recorded sequences are dimly lit, scenes with no sequences recorded are not lit, and currently selected sequences are fully lit.

### 2 Press a 16-step key set with a sequence.

The scene is selected, and the unit switches to the state for selecting a pattern in that scene.

- For details on switching the pattern, refer to *Switching the pattern*.
- Press the [SCENE] button to exit scene switching mode.
- The display returns to the previous scene if the mode is exited without switching the pattern.
- Pressing and holding the [SCENE] button sets the SCENE JUMP mode to continue the scene switching mode even if the scene is switched. The [SCENE] button flashes in white while in the SCENE JUMP mode.

## Changing the length of a pattern

### 1 Press the [PATTERN] button while pressing the [SHIFT] button.

The unit switches to pattern length setting mode, and the [PATTERN] button blinks white. During pattern length setting mode, the 16-step key lights white, and the measure selection key lights blue.

- A pattern length from a minimum of 1 step to a maximum of 64 steps can be set.

### 2 Press a bar selection key.

Set the length of the pattern using bar units. The bar selection keys from bar selection key [1] to the pressed bar selection key light in blue.

### 3 Press the 16-step keys.

Set the length of the pattern on a step level. The 16-step keys pressed from 16-step key [1] to 16-step key [16] light in white.

- Press the [PATTERN] button to exit pattern length setting mode.

## Loading a sample to a track

### 1 Tap the track to which you wish to load the sample on the home screen and then tap again in the selected state.

The track menu screen appears.

- The track menu can also be displayed by turning the rotary selector to select a track and then pressing the rotary selector.



### 2 Tap [BROWSE].

The browse screen appears. You can search for samples and load samples to tracks on the browse screen.

- The browse screen can also be displayed by turning the rotary selector to select [BROWSE] and then pressing the rotary selector.



### 3 Turn the rotary selector to select a sample and then press the rotary selector.

The sample is loaded to the track, and loaded on the screen.



- Select a folder and press the rotary selector to open or close the folder.
- Turn the rotary selector while pressing the [SHIFT] button to move the focus between folders (sample files are skipped).

---

---

## Using the performance pads

---

### Playing a sample sound

#### 1 Set all of the [MUTE] button, [HOT SLICE] button, [SLICE] button, and [SCALE] button to OFF.

All of the buttons are set to the off state.

#### 2 Tap the performance pads.

The sample assigned to each performance pad plays.

---

### Recording a performance (dynamic recording)

#### 1 Press the [REC] button.

The [REC] button lights up in red and the unit enters the recording state.

#### 2 Press the [PLAY/PAUSE ►/II] button.

The [PLAY/PAUSE ►/II] button lights up in green and the sequence plays while the unit is in the recording state.

#### 3 Tap the performance pads to set triggers.

A trigger is set when the pad is tapped. The step key to which the trigger was input lights or flashes in the track color.

---

## Using the operation modes of the performance pads

Four operation modes are available.

### ❖ Muting a track (MUTE mode)

Tracks assigned to performance pads can be muted by pressing the [MUTE] button.

#### 1 Press the [MUTE] button.

The [MUTE] button lights up in white.

#### 2 Press the performance pad to mute the assigned track.

The performance pad whose track is muted turns off.

- You can mute multiple tracks at the same time.
- To cancel mute, press the performance pad corresponding to the muted track again.
- If a performance pad is pressed while pressing the [SHIFT] button in the mute mode, the sound plays only for the track corresponding to the performance pad. (SOLO mode)
  - Solo can be set for multiple tracks at the same time.
  - To cancel solo, press the performance pad for which the sound is playing again while pressing the [SHIFT] button.
  - When all solo states are canceled, the previous mute state is restored.
- Pressing the [MUTE] button while pressing the [SHIFT] button cancels all mute states and solo states.

#### 3 Press the [MUTE] button again.

The [MUTE] button turns off and the MUTE mode ends.

- Mute can also be set by pressing a performance pad while pressing the [MUTE] button. In that case, the MUTE mode ends once you release the [MUTE] button.

### ❖ Playing a hot slice performance (HOT SLICE mode)

Sliced sample sounds assigned to performance pads can be played from the sliced sample position to the end of the sample by pressing the [HOT SLICE] button.

#### 1 Select the track for which you wish to play a hot slice performance of the sample assigned to it.

#### 2 Press the [HOT SLICE] button.

The [HOT SLICE] button lights in white.

- The sample is sliced equally into 16 and the slices are assigned to the performance pads in order.
- Press and hold down the [HOT SLICE] button to display the SET SLICE screen and enter the HOT SLICE mode.

#### 3 Tap the performance pads.

The sample assigned to each performance pad plays.

#### 4 Press the [HOT SLICE] button again.

The [HOT SLICE] button turns off and the HOT SLICE mode ends.

### ❖ Playing a slice performance (SLICE mode)

Sliced sample sounds assigned to performance pads can be played by pressing the [SLICE] button.

#### 1 Select a track to play a slice performance of the sample assigned to it.

#### 2 Press the [SLICE] button.

The [SLICE] button lights up in white.

- The sample is sliced equally into 16 and the slices are assigned to the performance pads in order.
- Press and hold down the [SLICE] button to display the SET SLICE screen and enter the SLICE mode.

#### 3 Tap the performance pads.

The sample assigned to each performance pad plays.

#### 4 Press the [SLICE] button again.

The [SLICE] button turns off and the unit exits slice performance mode..

### ❖ Playing a scale performance (SCALE mode)

Samples of scales assigned to performance pads can be played by pressing the [SCALE] button.

#### 1 Select a track to play a scale performance of the sample assigned to it.

#### 2 Press the [SCALE] button.

The [SCALE] button lights up in white.

- A sample can be played using the scale set on the SET SCALE screen, treating the bottom left performance pad as the root key.
- Press and hold down the [SCALE] button to display the SET SCALE screen and enter the SCALE mode.

#### 3 Tap the performance pads.

Samples are played in the scale assigned to each performance pad.

#### 4 Press the [SCALE] button again.

The [SCALE] button turns off and the SCALE mode ends.

- Trigger step input is possible using one of the following two methods for a HOT SLICE mode performance, SLICE mode performance, and SCALE mode performance.
  - Tap the pad you wish to play and then press the 16-step key of the step you wish to input.
  - While pressing the 16-step key of the step you wish to input, tap the pad you wish to input for that step.

## Using the step keys parameter adjustment knobs

### Programming triggers (step recording)

#### 1 Tap the track for step recording on the home screen.

The sequence of the selected track is displayed on the 16-step keys.

- A track can also be selected by turning the rotary selector.
- A track can also be selected by tapping a performance pad.

#### 2 Press the 16-step keys to input triggers.

The step keys corresponding to the programmed sequence light up in the track color.

### Changing track parameters

#### 1 Press the [HOME] button.

The HOME screen appears.

#### 2 Select a track to change the parameters of the samples assigned to it.

#### 3 Turn the parameter adjustment knobs.

The parameter corresponding to each parameter adjustment knob changes. The parameter values are displayed at the bottom of the touch display.

- Turn the parameter 1 adjustment knob (changes the volume). The volume of the track changes. Turning the parameter adjustment knob while pressing the [SHIFT] button changes the parameter one level at a time.
- Turn the parameter 2 adjustment knob (changes the pitch of the sound). The sound pitch of the track changes.
- Turn the parameter 3 adjustment knob (enables or disables [VELOCITY] of the pads). Enable or disable the velocity for when tapping pads.
- Turn the parameter 4 adjustment knob (sets the time stretch). The sample is stretched to synchronize with the BPM (time stretch is set).
- Turn the parameter 5 adjustment knob (sets loop playback). Sample loop playback is switched.
- Turn the parameter 6 adjustment knob (sets the sample playback method). Sample playback method for triggers is switched.
- For details on the adjustment knob operations, refer to *Making overall settings, adjustments, and checks (HOME)* (p.15).

## Changing parameters by step (step modulation)

#### 1 Tap the track for which you wish to change the sound on the home screen and then tap again in the selected state.

The track menu screen appears.

- The track menu can also be displayed by turning the rotary selector to select a track and then pressing the rotary selector.

#### 2 Tap [PLAYBACK] and tap again in the selected state.

The PLAYBACK screen appears.

- You can also go to the PLAYBACK screen by turning the rotary selector to select [PLAYBACK] and then pressing the rotary selector.



#### 3 Turn the parameter adjustment knob while pressing a 16-step key to change the parameter for that step.

The parameter changes.

- The name of the parameter to which step modulation is applied is displayed in red.

## Using the touch strip function

### Using PITCH

#### 1 Press the [MODE] button to select [PITCH].

The [PITCH] indicator to the right of the [MODE] button lights up.

- Each press of the [MODE] button changes the [MODE] indicator in the order of [PITCH] → [REPEAT] → [USER1] → [USER2] → and so on.

#### 2 Press and hold the performance pad to change the pitch of the sample assigned to it.

The sample sound assigned to the performance pad plays.

#### 3 Touch the touch strip to change the parameter.

The pitch of the sample sound changes according to the position touched on the touch strip. The touch strip indicator of the position touched on the touch strip lights up.

- The range for changing the pitch using the touch strip can be set in [TOUCH STRIP SETTING (PITCH RANGE)] of UTILITY.
- The pitch can also be changed by pressing the performance pad while touching the touch strip.
- The effect of the touch strip only continues while a performance pad is pressed. It cannot be used in a sequence.

---

## Using REPEAT

### 1 Press the [MODE] button to select [REPEAT].

The [REPEAT] indicator to the right of the [MODE] button lights up.

- Each press of the [MODE] button changes the [MODE] indicator in the order of [PITCH] → [REPEAT] → [USER1] → [USER2] → and so on.

### 2 Press and hold the performance pad to repeatedly play the sample assigned to it.

The sample sound assigned to the performance pad plays.

### 3 Touch the touch strip to change the parameter.

The sample sound is played repeatedly according to the position touched on the touch strip. Also, the touch strip indicator of the position touched on the touch strip lights up.

- The range for the repeat interval using the touch strip is as follows.  
1/8 beat → 1/4 beat → 1/2 beat → 1/1 beat
- The sample sound can also be played back repeatedly by pressing the performance pad while touching the touch strip.
- The effect of the touch strip only continues while a performance pad is pressed. It cannot be used in a sequence.

### 4 Change the force applied to the performance pad.

The sample volume changes according to the increase or decrease in force applied to the performance pad. Pressing down with a stronger force increases the volume and pressing with a weaker force decreases the volume.

---

## Using with USER setting

### 1 Press the [MODE] button to select [USER1] or [USER2].

The [USER1] or [USER2] indicator to the right of the [MODE] button lights up.

- Each press of the [MODE] button changes the [MODE] indicator in the order of [PITCH] → [REPEAT] → [USER1] → [USER2] → and so on.

### 2 Set the parameters to be changed with [USER1] or [USER2].

Configure the settings of the parameters on the TOUCH STRIP SETTING (USER1) screen or TOUCH STRIP SETTING (USER2) screen.

### 3 Press and hold the performance pad to change the parameters of the sample assigned to it.

The sample sound assigned to the performance pad plays.

### 4 Touch the touch strip to change the parameter.

The sample sound changes according to the position touched on the touch strip. Also, the touch strip indicator of the position touched on the touch strip lights up.

- The effect of the touch strip only continues while a performance pad is pressed. It cannot be used in a sequence.

---

## Using HOLD

### 1 Press the [HOLD] button.

The [HOLD] button lights up.

### 2 Touch the touch strip.

The sample sound is put on hold at the last-touched position and the touch strip indicator lights up.

- If the mode is switched, the hold function is canceled and the [HOLD] button turns off.

---

## Saving a project

A project can be saved to a USB device. When saving a project, connect a USB device to the unit.

### 1 Press the [PROJECT] button.

The PROJECT screen appears. You can perform operations such as loading and saving projects on the PROJECT screen.

### 2 Turn the rotary selector to select [SAVE] and then press the rotary selector.

If the project name has already been entered, a saving pop-up screen appears. The progress is indicated by a progress bar in the pop-up screen.

If the project name has not been entered, a pop-up screen and software keyboard for setting the project name appear.

- The pop-up window disappears and the PROJECT screen appears when the saving process is completed.
- To change the project name select [SAVE AS], enter a project name, and then save the project.

---

## Turning off the system

### Press the [⏻] switch on the rear panel of the unit.

- Do not disconnect the USB device or turn off this unit while the USB indicator is lit or flashing. Doing so could delete the management data of this unit and damage the USB device, resulting in unreadable data.

# Advanced operation

## Making overall settings, adjustments, and checks (HOME)

This screen serves as the base of all screens. It allows you to check the assignment status of the performance pads and the status of each track.

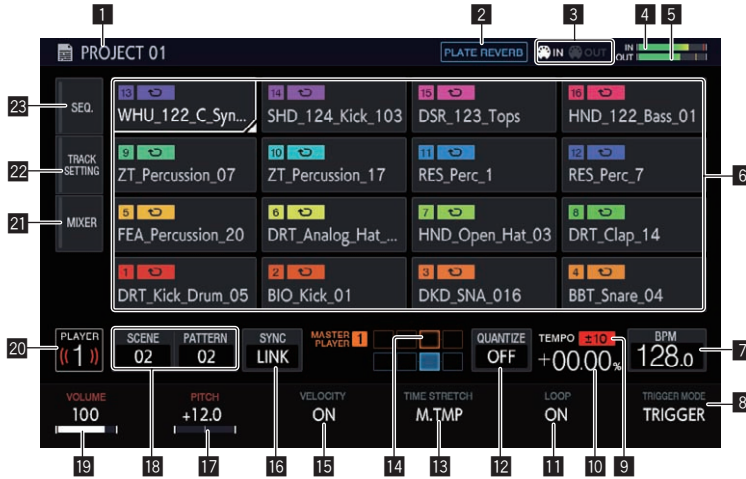

### 1 Project name

Displays the name of the loaded project.

### 2 Effect name

The name of the selected effect is displayed.

### 3 Status display

Displays the status of the connection with an external device.

### 4 Input sound level meter

Displays the level meter for the sound input to the [INPUT] terminals. The level can be adjusted with the [INPUT LEVEL] control.

### 5 MASTER level meter

Displays the MASTER level meter.

When operating [VOLUME] of each track in the touch display, adjust the volume so that the peak becomes close to 0 dB.

- A peak hold display function is provided, and the detected maximum level position is displayed. After that, the indication disappears if an even larger signal is not detected within a certain period of time (about 500 ms).

### 6 Track display

Track selection

Selected state	Unselected state

One of the tracks is always selected. Track 1 is selected by default. A track can be selected by tapping it. Tapping the selected track again (or pressing the rotary selector) displays the track menu screen.

If you turn the rotary selector, the track selection position moves. Turn it clockwise to move the position in ascending order from track 1 to 16, and then from 16 back to 1. Turn it counterclockwise to move the position in the reverse direction.

- For details on the displayed content in a track, refer to *Track display content*.

### 7 BPM

Displays the BPM of the pattern being played. Tap this to display the BPM screen.

- ➔ *Setting BPM (BPM)* (p. 19)

### 8 TRIGGER MODE

Switches the method in which a sample is displayed in response to a trigger.

#### OneShot:

When the performance pad is tapped, the sample is played to the end.

#### GATE:

The sample is played only while the performance pad is pressed.

### 9 Playing speed adjustment range display

Displays the range in which the playing speed can be adjusted with respect to the original playing speed recorded for the project or scene.

### 10 Playing speed display

The value changes according to the position of the [TEMPO] slider.

### 11 LOOP

Switches loop playback on/off.

### 12 QUANTIZE

Tap this to display the QUANTIZE screen.

- ➔ *Setting quantize (QUANTIZE)* (p. 19)

### 13 TIME STRETCH

Sets the method of stretching a sample to synchronize the BPM.

#### OFF:

Plays the sample in its current state without synchronizing it to the BPM. This is suitable for one shot of a drum, etc.

#### RESMPL (RESAMPLE):

Synchronizes the sample to the BPM, but changes the pitch (variable speed playback). This is suitable for a drum loop, etc.

#### M.TMP (MASTER TEMPO):

Synchronizes the sample to the BPM, but does not change the pitch (MASTER TEMPO playback). This is suitable for a melody loop, etc.

### 14 PHASE METER

Indicates the amount of divergence of the bars and beats from the master player when using the beat sync function.

### 15 VELOCITY

The [VELOCITY] of a pad can be enabled or disabled.

When this is ON, the playback volume of the sound source changes according to the strength that the pad is tapped.

When this is OFF, the sound source plays at a fixed volume which is dependent on the [VELOCITY] set in [AMP ENVELOPE].



## 16 SYNC

Tap this to display the SYNC screen.

- *Setting synchronization with externally connected device (SYNC)* (p. 20)

## 17 PITCH

Sets the sound pitch for sample playback.

## 18 SCENE/PATTERN button

Displays the current scene number and pattern number.

Tap this to display the SCENE MANAGER screen.

- *Managing scenes and patterns (SCENE MANAGER)* (p. 21)

## 19 VOLUME

Sets the volume of the track.

## 20 Player number

Displays the player number assigned to this unit.

## 21 MIXER

Tap this to display the mixer screen.

- *Adjusting the volume of each track (MIXER)* (p. 18)

## 22 TRACK SETTING

Tap this to display the TRACK SETTING screen.

- *Changing the settings of the entire track (TRACK SETTING)* (p. 17)

## 23 SEQ.

Tap this to display the sequence screen.

- *Checking sequences (SEQ.)* (p. 18)

# Track display content

## Track attributes

The display content differs for each track attribute.

The attribute can be switched in TRACK MENU of each track.

### ❖ SAMPLE track

The display content differs for each track attribute.

The attribute can be switched in TRACK MENU of each track.

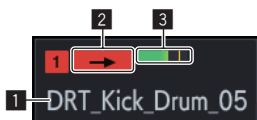

This track plays a sample.

### 1 Name of the assigned sample

If a sample is assigned to a track, the name of the assigned sample is displayed.

If the sample name will not fit within the field, part of it is omitted and the omitted part is replaced with "..."

### 2 TRIGGER MODE and LOOP

Indicates the state of how the assigned sound is played.

Turning **LOOP** on and off affects both pad performances and sequence performances, but **TRIGGER MODE** only affects pad performances.

	LOOP	TRIGGER MODE
➔	OFF	OneShot
⋮➔	OFF	GATE
↻	ON	OneShot
↻⋮	ON	GATE

- This can be switched with the parameter adjustment knobs at the bottom of the touch display.
- In the case of **GATE**, the sample is played only while the pad is pressed.
- In the case of **OneShot**, the sample is triggered the instant the performance pad is pressed, and is played only for the specified time.

## 3 Level meter display

Displays the audio level meter while a sample is playing.

### ❖ THRU track

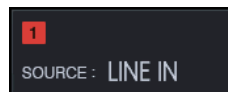

### ❖ MIDI/TORAIZ AS-1 track



The number of the MIDI channel is displayed.

## ACTIVE/MUTE

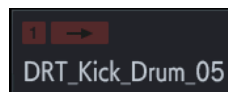

If [**MUTE**] is performed by pad operation, the indicators in the area indicating the track number are all grayed out.

# Managing project files (PROJECT)

Operations such as configuration, loading, and saving can be performed on a project basis.

## Creating a new project

### 1 Press the [PROJECT] button.

The PROJECT screen appears. You can perform operations such as loading and saving projects on the PROJECT screen.

### 2 Turn the rotary selector to select [CREATE NEW] and then press the rotary selector.

A new project is created and the main screen appears.

- A confirmation pop-up screen appears.
- If a new project is created without saving an existing project after the project is changed, the unsaved project will be lost.

## Deleting a project

### Turn the rotary selector to select [DELETE] and then press the rotary selector.

An existing project can be deleted.



## Saving a project as a package

A project can be saved as a package. The ability to convert a project file and the samples used in that project to a single file enables users to exchange projects among each other.

### 1 Select [SAVE AS PACKAGE] in the project screen.

A pop-up screen for entering the package name appears.

### 2 Enter the package name and then tap [SAVE TO USB].

The PACKAGE\_NAME.tpkg file is saved to the /PIONEER DJ SAMPLER/Projects/ folder.

- If a package file with the same name already exists, an overwrite confirmation pop-up screen appears.

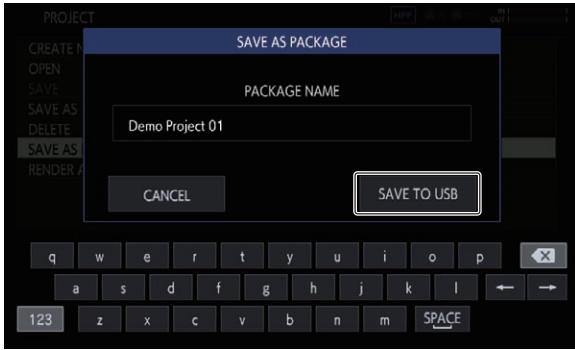

## ❖ Importing a package

### 1 Place the package file in the folder.

Copy the package file (extension: .tpkg) to the /PIONEER DJ SAMPLER/Projects/ folder of the USB device.

### 2 Tap [OPEN] in the project screen.

The project and package list appears.

### 3 Open the .tpkg file you placed.

A confirmation pop-up appears. Tap [OK] to import the package.

- When the loaded package is saved as a project, the samples included in the package are copied to the /PIONEER DJ SAMPLER/Samples/[Imported]/Project Name/ folder.

## Changing the settings of the entire track (TRACK SETTING)

The settings of each pad can be configured.

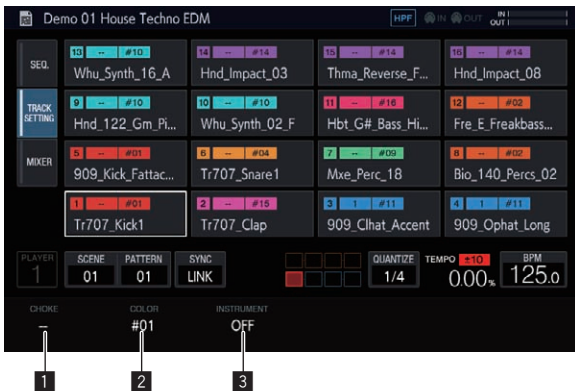

### 1 CHOKE

Tracks set to the same CHOKE No. can be set to not be played at the same time.

- "--" (none), [1], [2], [3], [4], [5], [6], [7], or [8] can be selected.
- The default is "--" (none).

### 2 PAD COLOR

The track color can be set to any of 16 colors.

### 3 INSTRUMENT

The instrument icons can be set.

## ❖ Swapping tracks

### 1 Turn the rotary selector to select a track you wish to swap and then press the rotary selector.

[SWAP FROM] appears.



### 2 Turn the rotary selector to move [SWAP TO] to the track of the swap destination and then press the rotary selector.

The tracks are swapped.



## Adjusting the volume of each track (MIXER)

The volume levels can be adjusted at the same time while looking at the volume levels and panning positions of multiple tracks.

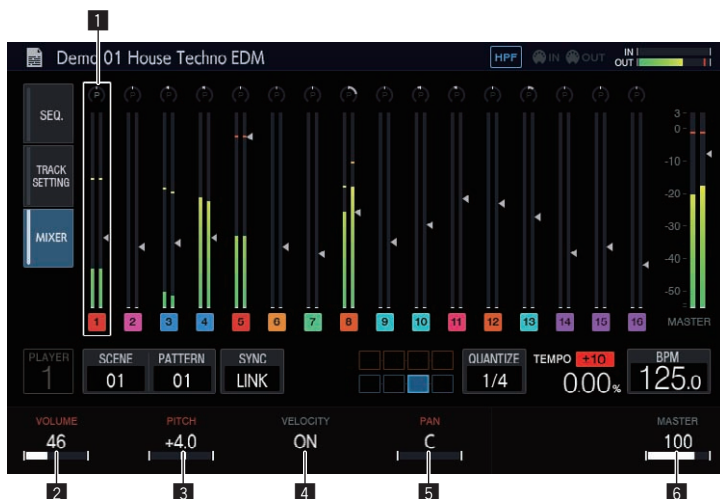

- The selected track is indicated by the white frame.
- Turning the rotary selector moves the frame to change the selected track.
- The frame moves between tracks 1 to 16, and the selected track is linked to the selection in the HOME screen.
- The **[MASTER]** parameter is a setting value that is common to that in the MIXER screen.

### 1 Track display

- PAN position
- Level meter
- Volume fader position
- Track number and track color

### 2 VOLUME

Sets the volume of the track.

### 3 PITCH

Sets the sound pitch for sample playback.

### 4 VELOCITY

The **[VELOCITY]** of a pad can be enabled or disabled.

### 5 PAN

Sets the panning position of the track.

### 6 MASTER

Adjusts the **MASTER** volume.

The setting value is common to that in the MIXER screen. The value is displayed regardless of the position of the frame.

## Checking sequences (SEQ.)

Display the currently playing sequence.

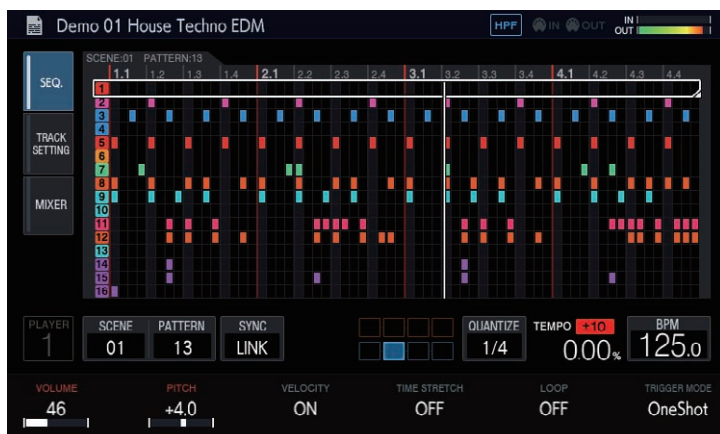

- Press a 16-step key while pressing the **[SHIFT]** button in the pattern switching mode.

You can check the sequence set for the selected pattern only while the 16-step key is being pressed.

---

---

## Setting BPM (BPM)

BPM setting and other operations related to playing sequences can be performed.

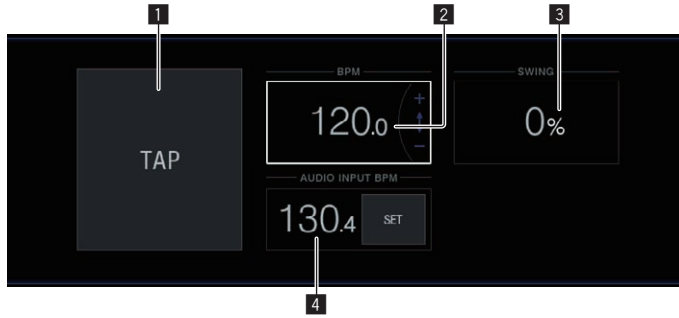

### 1 TAP

Tapping this multiple times to match the beat sets the BPM value to match that interval.

### 2 BPM

This is the BPM value set for the project. The BPM when the playing speed is 0% also becomes this value.

It can be changed by turning the rotary selector.

- Pressing **[SHIFT]** + turning the rotary selector changes the fractional value.

### 3 SWING

The **[SWING]** value can be set.

### 4 AUDIO INPUT BPM

The BPM of the sound input to the **[INPUT]** terminals is automatically analyzed and then displayed.

The BPM measurement range is BPM = 70 to 180.

For some tracks, correct measurement may not be possible. When the BPM cannot be detected, the previously detected BPM value is displayed and flashes.

---

---

## Setting quantize (QUANTIZE)

The operation of the performance pads and 16-step keys can be set.

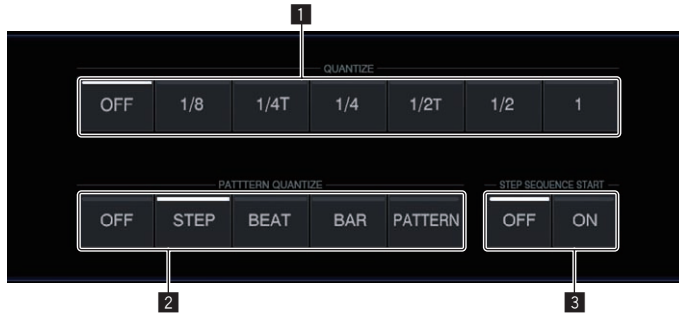

### 1 QUANTIZE

Sets the quantize values for when a performance pad is tapped during sequencer playback.

### 2 PATTERN QUANTIZE

Sets the timing for switching when a pattern is switched.

### 3 PAD SEQUENCE START

Sets whether or not to play the sequencer when a performance pad is tapped while the sequencer is stopped.

# Setting synchronization with externally connected device (SYNC)

The settings for synchronization with a PRO DJ LINK compatible DJ player or external MIDI device can be configured.



## 1 SYNC SETTING

Sets the synchronization method for playback synchronized with a PRO DJ LINK compatible DJ player.

- **BEAT SYNC:** Synchronizes with the DJ player that will be the master on the beat level.
- **BAR SYNC:** Synchronizes with the DJ player that will be the master on the bar level.

## 2 MIDI I/F SELECT

Selects the interface for exchanging MIDI messages.

- **DIN MIDI:** Exchanges MIDI messages with the [MIDI IN] and [MIDI OUT/THRU] terminals.
- **USB MIDI:** Exchanges MIDI messages with the [USB-B] terminal.
- **DIN MIDI(THRU H/W):** Outputs the signal input to the [MIDI IN] terminal through the hardware from the [MIDI OUT/THRU] terminal.

## 3 SYNC SOURCE SELECT

Sets the target with which the unit will synchronize.

- **PRO DJ LINK**  
If the unit and a PRO DJ LINK compatible DJ player are connected with a LAN cable, the sequence of the unit can be played matched to the playback tempo, beat, or bar of the DJ player. The tracks played with the DJ player need to have been analyzed by rekordbox in advance.
- **MIDI**  
If the unit and an external MIDI device are connected by DIN or USB, the sequence of the unit can be played matched to the playback tempo of the external MIDI device. When MIDI is selected, the [BEAT SYNC] button, [TEMPO RESET/SET] button, [NUDGE] button, and TEMPO slider cannot be operated.

## 4 Synchronization status display

Displays the status for synchronization with an external device according to the setting states of **SYNC SOURCE SELECT**, **MIDI I/F SELECT**, [BEAT SYNC MASTER] button, and [BEAT SYNC] button.

## Canceling synchronization

### Press the [BEAT SYNC] button.

Synchronization is canceled.

- If the synchronized playback tempo (BPM) and the **TEMPO** slider position's tempo (BPM) do not match, the synchronized playback tempo is maintained and tempo control with the **TEMPO** slider remains disabled. Normal operation is restored when the position of the **TEMPO** slider is moved to the synchronized playback tempo position.
- Operating the [NUDGE] button also cancels synchronization, and switches to the BPM sync state. At that time, the [SYNC] button flashes.

## Playback synchronized with a PRO DJ LINK compatible DJ player.

### 1 Press the [BEAT SYNC MASTER] button of the DJ player you wish to set as the sync master.

Select the DJ player to be set as the sync master.

### 2 Press the [BEAT SYNC] button.

The BPM and beat position of the currently playing track are synchronized to the sync master.

- During synchronization, tempo control with the **TEMPO** slider is disabled. Also, the playing speed display changes to the BPM display of the **TEMPO** slider position, and is displayed in gray.

# Managing scenes and patterns (SCENE MANAGER)

If you tap **[SCENE/PATTERN]**, the SCENE MANAGER screen appears.

Scenes, patterns, sequences, and tracks can be copied or deleted in the SCENE MANAGER screen.

## Copying and deleting scenes and patterns

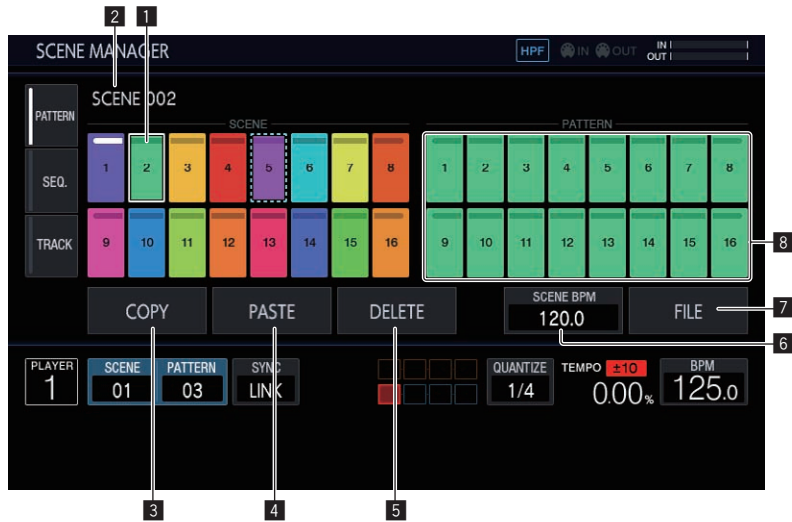

### 1 Scene display area

Turn the rotary selector to select a scene, and move the focus to the pattern display area by pressing the rotary selector.

The operation can also be performed by tapping a touch key on the touch display.

The indicator at the top of the touch key is lit in white for the currently set scene.

### 2 Scene name

Displays the selected scene name.

This is not displayed if a scene name has not been set.

### 3 COPY

Copies the selected scene or pattern.

The scene or pattern that is copied has an indicator (dotted-line frame) to indicate that it is copied.

### 4 PASTE

Pastes the copied scene or pattern to the selected location.

This cannot be pressed if nothing is copied. In that case, **[PASTE]** is grayed out. Furthermore, **[PASTE]** can also not be tapped when the focus is on a pattern while a scene is in a copied state or vice versa.

In that case too, **[PASTE]** is grayed out.

### 5 DELETE

Deletes the selected scene or pattern.

A confirmation pop-up is displayed when deleting a scene or pattern.

### 6 SCENE BPM

Sets the BPM of the selected scene.

➔ *Setting the BPM of a scene* (p. 22)

### 7 FILE

Imports or exports a scene file.

➔ *Importing a scene file* (p. 22)

➔ *Exporting a scene file* (p. 22)

### 8 Pattern display area

Turn the rotary selector to select a pattern, and enter the pattern by pressing the rotary selector.

The operation can also be performed by tapping a touch key on the touch display.

The indicator at the top of the touch key is lit in white for the currently set pattern.

If the pattern is switched during playback, the switching timing will be in accordance with the **PATTERN QUANTIZE** setting value set in the QUANTIZE screen. At that time, the indicator flashes in white for the touch key while waiting for the pattern to change.

## 1 Tap **[SCENE/PATTERN]** to display the SCENE MANAGER screen.

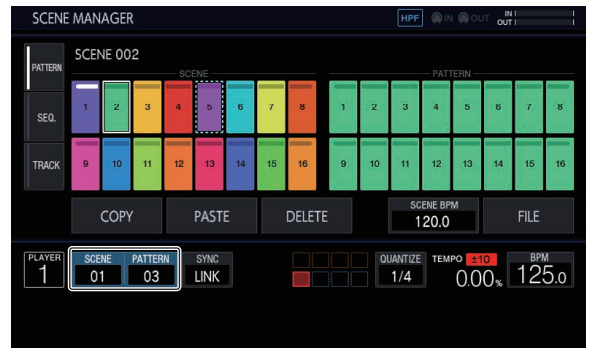

## 2 Tap the **[PATTERN]** tab to display the scene/pattern editing screen.

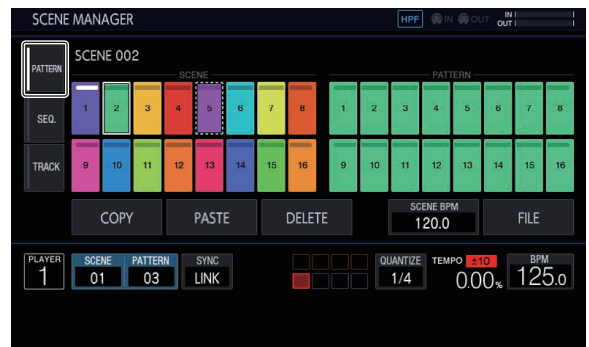

## ❖ Exporting a scene file

Collect all the samples used in the currently selected scene and export them in a file format that allows the same scene to be imported by another project or unit.

### 1 Select the scene you wish to export in the SCENE MANAGER screen and then tap [FILE].

A pop-up screen appears.

### 2 Turn the rotary selector to select [EXPORT] and then press the rotary selector.

The keyboard screen for entering the scene name appears.

### 3 Use the screen keyboard to enter the scene name.

- When saving to a USB memory device, tap [SAVE TO USB].  
The scene file is a file with the .scn extension in the Scenes folder.  
The save destination is under PIONEER DJ SAMPLER/Scenes.

## ❖ Importing a scene file

Import a file with the .scn extension in the Scenes folder of a USB memory device.

### 1 Select the scene you wish to import in the SCENE MANAGER screen and then tap [FILE].

A pop-up screen appears.

### 2 Turn the rotary selector to select [IMPORT] and then press the rotary selector.

The file list appears.

### 3 Turn the rotary selector to select the scene you wish to import and then press the rotary selector.

- Importing of the file begins.

## ❖ Deleting a scene file

Delete a file with the .scn extension in the Scenes folder of a USB memory device.

### 1 Select the scene you wish to delete in the SCENE MANAGER screen and then tap [FILE].

A pop-up screen appears.

### 2 Turn the rotary selector to select [DELETE] and then press the rotary selector.

The file list appears.

### 3 Turn the rotary selector to select the scene you wish to delete and then press the rotary selector.

- Deleting of the file begins.

## ❖ Setting the BPM of a scene

A BPM value can be set for each scene. This BPM value is common for all patterns in the scene as a BPM value cannot be set for each pattern.

- When the pattern is switched to a pattern in a scene with the BPM set, the BPM value in the BPM screen also becomes the BPM value of the scene and the scene is played at that tempo. When a BPM value is not set for a scene, “---” is displayed and the scene is played using the BPM value set in the BPM screen.
- During playback of a pattern in a scene with the BPM set, the tempo can be adjusted by changing the BPM value in the BPM screen. However, that BPM value is not reflected as the BPM value of the scene. Set the BPM value of a scene in the BPM setting in SCENE MANAGER.

If you tap [SCENE BPM] in the SCENE MANAGER screen, the SET SCENE BPM screen appears.

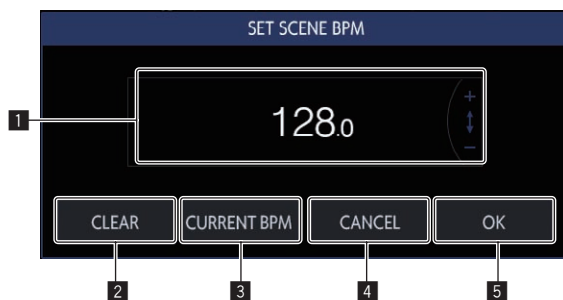

#### 1 BPM

Change the BPM value of a scene using the rotary selector.

#### 2 CLEAR

Tap this to reset the BPM value of the set scene. The indication becomes “---” and when a pattern of this scene is played, it is played using the BPM value set in the BPM screen. When this scene is output, the BPM value set in the BPM screen is output as the BPM value of the scene.

#### 3 CURRENT BPM

Sets the currently playing BPM as the BPM value of the scene.

#### 4 CANCEL

Closes the pop-up. At this time, the BPM value of the scene returns to the value when the pop-up was opened.

#### 5 OK

Enters the BPM value of the scene and closes the pop-up.

## Copying and deleting sequences

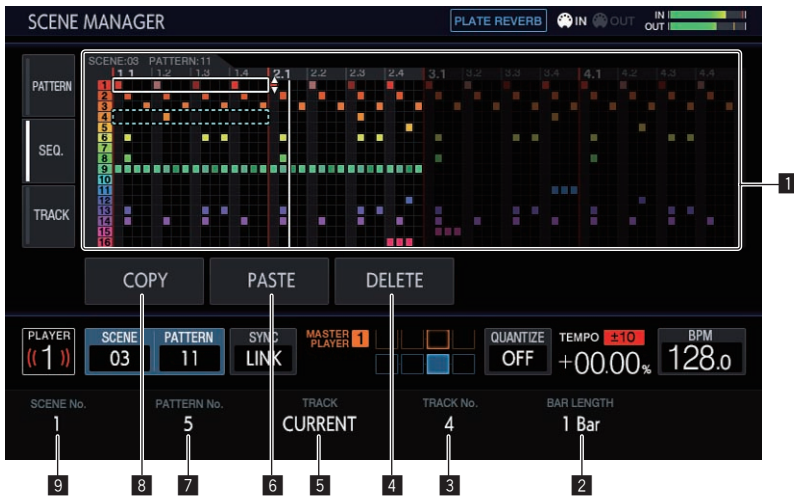

### 1 Sequence display area

Turn the rotary selector to select a sequence. You can switch between the horizontal direction and vertical direction by pressing the rotary selector.

### 2 BAR LENGTH

Selects the range of the sequence to copy or delete from 1 bar and 4 bars.

### 3 TRACK No.

Selects a track.

### 4 DELETE

Deletes the selected sequence.

### 5 TRACK

Selects the range of the sequence to copy or delete from 1 track and all (16 tracks).

### 6 PASTE

Pastes the copied sequence to the selected location. This cannot be pressed if nothing is copied. In that case, the [PASTE] button is grayed out.

### 7 PATTERN No.

Selects the pattern.

### 8 COPY

Copies the selected sequence. The sequence that is copied has an indicator (dotted-line frame) to indicate that it is copied.

### 9 SCENE No.

Selects the scene.

### 1 Tap [SCENE/PATTERN] to display the SCENE MANAGER screen.

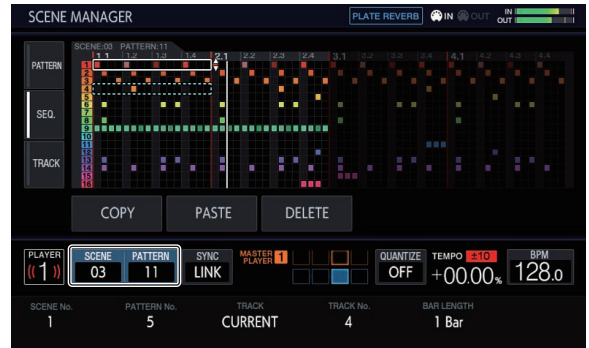

### 2 Tap the [SEQ.] tab to display the sequence editing screen.

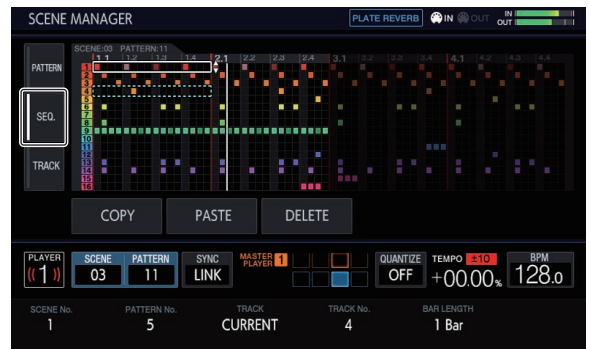



## Copying and deleting tracks

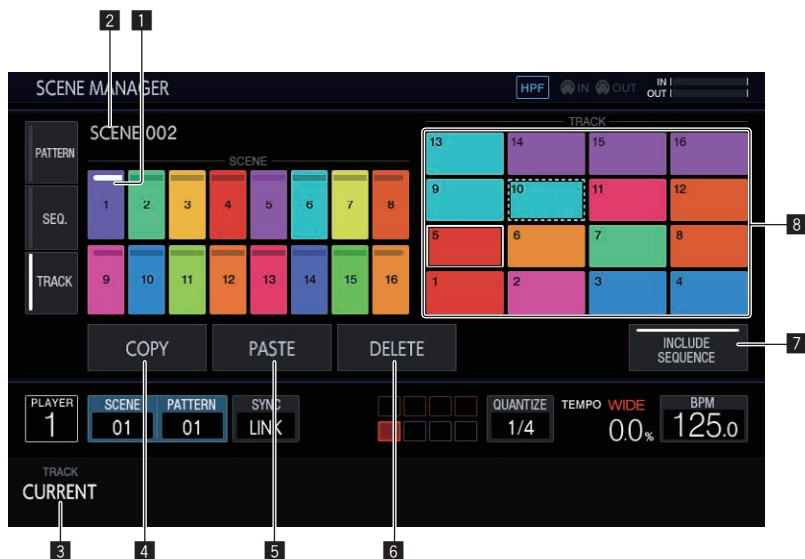

### 1 Scene display area

Turn the rotary selector to select a scene, and move the focus to the track display area by pressing the rotary selector. The operation can also be performed by tapping a touch key on the touch display. The indicator at the top of the touch key is lit in white for the currently set scene.

### 2 Scene name

Displays the selected scene name. This is not displayed if a scene name has not been set.

### 3 TRACK

Selects the range of the sequence to copy or delete from 1 track and all (16 tracks).

### 4 COPY

Copies the selected track. The track that is copied has an indicator (dotted-line frame) to indicate that it is copied.

### 5 PASTE

Pastes the copied track to the selected location. This cannot be pressed if nothing is copied. In that case, [PASTE] is grayed out. Furthermore, [PASTE] can also not be tapped when the focus is on a scene while a track is in a copied state. In that case too, [PASTE] is grayed out.

### 6 DELETE

Deletes the selected track. A confirmation pop-up is displayed when deleting a track.

### 7 INCLUDE SEQUENCE

If [INCLUDE SEQUENCE] is tapped to switch it on, the sequence will also be included when copying.

➔ *Checking sequences (SEQ.)* (p. 18)

### 8 Track display area

Enter a track by turning the rotary selector to select the track and then pressing the rotary selector. The operation can also be performed by tapping a touch key on the touch display.

### 1 Tap [SCENE/PATTERN] to display the SCENE MANAGER screen.

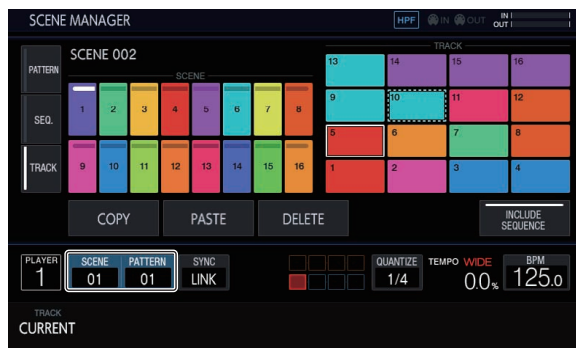

### 2 Tap the [TRACK] tab to display the track editing screen.

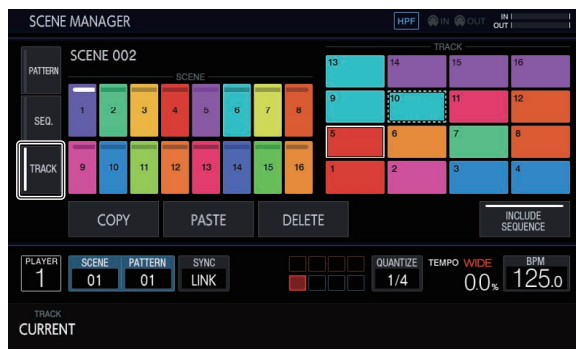



## Audio rendering (RENDER AUDIO)

A created pattern can be exported as a WAV file (44.1 kHz, 24-bit). Press the [PROJECT] button and select [RENDER AUDIO] from the PROJECT menu to switch to the page for audio rendering.

- The sequencer and sound output of the unit are stopped during rendering execution.

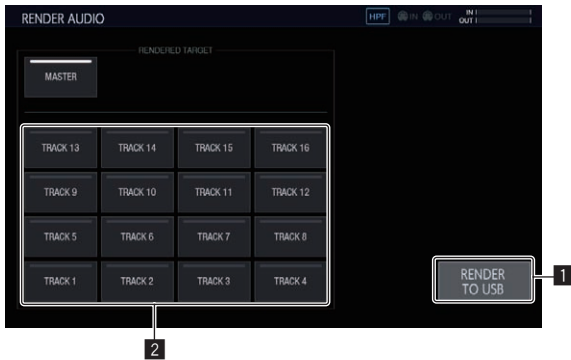

### 1 RENDER TO USB

Starts rendering. A rendered track is saved to the USB memory device.

- If a USB memory device is not connected, the button is displayed grayed out and cannot be operated.

### 2 RENDERED TARGET

Selects the track to be the rendering target.

## Rendering audio

### 1 Tap [RENDER TO USB].

Rendering starts. When audio rendering finishes, a pop-up screen notifying you that rendering was successful appears. The progress is indicated by a progress bar in a pop-up during audio rendering.

- To cancel audio rendering part way through, tap [CANCEL].

### 2 Tap [OK].

A rendered audio file cannot be accessed from the browse screen of the unit. Import it to a computer and then use it for editing and mastering.

- The save destination of a WAV file is PIONEER DJ SAMPLER/Rendered Audio/[Project Name]/Pattern.
- Rendering results with the same conditions are always overwritten. When rendering is performed, be sure to move or copy the file to a computer.
- The file name will be [Scene No.][Pattern No.]\_[Rendering Target Name].wav.

## Sampling (LIVE SAMPLING)

### Sampling

The sound input to the [INPUT] terminals can be sampled and then used for a performance immediately.

#### 1 Press the [SAMPLING] button.

The performance pads switch to the LIVE SAMPLING mode and live sampling becomes possible.

- The [SAMPLING] button lights.
- The LIVE SAMPLING screen is displayed on the touch display.



- Adjust the level of sound with the [INPUT LEVEL] control before sampling. At that time, you can switch whether or not to output the sound input to the [INPUT] terminals by MONITOR to the headphones.

#### 2 Tap a performance pad without a sample loaded.

Sampling starts.

- A sampled sample is indicated with red characters.
- Some functions such as unloading and saving are restricted during sampling.

If another sample is already loaded in the performance pad for which you wish to perform sampling, unload it as described below.

- ① Tap the track you wish to unload.

Multiple tracks can be selected by tapping tracks while pressing the [SHIFT] button.

- ② Tap [UNLOAD] to execute unloading.

- The length for sampling can be set in **REC LENGTH**.

— The values that can be set are **1/4, 1/2, 1, 2, 4, 8, 16**, and **MANUAL**. (They are all set on a beat level.)

— If [MANUAL] is selected, tapping the same performance pad again finishes sampling. If the performance pad is not tapped, sampling up to the maximum of 32 seconds is performed.

- You can set in **LOOP AFTER REC** whether or not to play a loop immediately after sampling.
  - ON: Plays automatically from the beginning of the sample after sampling finishes.
  - OFF: Stops after sampling finishes.
- When the length set in **REC LENGTH** is reached or the same performance pad is tapped again while **MANUAL** is selected, sampling finishes.

#### 3 When sampling is finished, press the [SAMPLING] button.

Sampling mode ends.

## Adjusting the play start position of a sample

If a sampled sound is offset, the play start position can be adjusted.

### 1 Press the [SAMPLING] button.

The performance pads switch to the LIVE SAMPLING mode and live sampling becomes possible.

- The [SAMPLING] button lights.
- The LIVE SAMPLING screen is displayed on the touch display.

### 2 Tap the track you wish to adjust and then tap again in the selected state.

The adjustment screen appears.

- You can also go to the adjustment screen by turning the rotary selector to select a track and then pressing the rotary selector.



### 3 Turn the parameter 3 adjustment knob.

The play start position of the sample changes.

- If you wish to adjust another sample, you can turn the rotary selector to select another track.

### 4 When adjustment is finished, press the [SAMPLING] button.

Sampling mode ends.

## Saving a sample

A sampled sample can be saved to a USB memory device.

If another project is loaded or the power is switched off without saving, the sampled sample will be deleted.

### 1 Press the [SAMPLING] button.

The performance pads switch to the LIVE SAMPLING mode and live sampling becomes possible.

- The [SAMPLING] button lights.
- The LIVE SAMPLING screen is displayed on the touch display.

### 2 Tap the track with the sample you wish to save loaded.

Multiple tracks can be selected by tapping tracks while pressing the [SHIFT] button.

### 3 Tap [Save] (Save).

Saving is executed. The [SAVING...] message is displayed during saving. When saving completes, the sample name that was indicated by red characters is displayed in white.

The save destination is under PIONEER DJ SAMPLER/Samples/Saved/[Project name].

- Some functions are restricted during saving.
- If a USB memory device is not connected, the button is displayed grayed out and cannot be operated.

### 4 After saving, press the [SAMPLING] button.

Sampling mode ends.

## Using effects

### 1 Press the [FX] button.

The [FX] button lights.

The PERFORMANCE FX effect selection screen appears.



### 2 Tap the effect you wish to use.

For the effect types, refer to "PERFORMANCE FX Types".

### 3 Tap the [SELECT TRACK] tab.

The PERFORMANCE FX track selection screen appears.



### 4 Tap the track for which you wish to apply the effect.

Multiple tracks can be selected by tapping tracks while pressing the [SHIFT] button.

- If you switch RELATED COLOR on and then tap a track, the tracks with the same color set are selected or deselected at the same time.
- If you switch RELATED INST. on and then tap a track, the tracks with the same instrument icon set are selected or deselected at the same time.

### 5 Press the [FX ON/OFF] button.

The effect is applied to the sound.

- If you turn the [FX LEVEL DEPTH] control or a parameter adjustment knob, the parameter is adjusted.
- The [FX ON/OFF] button flashes when the effect is on.
- When the [FX ON/OFF] button is pressed again, the effect turns off.

## PERFORMANCE FX Types

Effect name	Descriptions	FX LEVEL DEPTH control	Parameter adjustment knobs
HPF	Outputs sound that has passed through a high-pass filter.	Changes the cutoff frequency of the high-pass filter. Rotating counter-clockwise: Decreases Rotating clockwise: Increases	① <b>RESONANCE:</b> 0 to 100 ② <b>SLOPE:</b> 12 dB and 24 dB
LPF	Outputs sound that has passed through a low-pass filter.	Changes the cutoff frequency of the low-pass filter. Rotating counter-clockwise: Increases Rotating clockwise: Decreases	① <b>RESONANCE:</b> 0 to 100 ② <b>SLOPE:</b> 12 dB and 24 dB
DUB ECHO	Outputs delayed sounds repeatedly after the original sound and gradually attenuates the delayed sounds to achieve an echo effect.	Changes the volume and reverberation time of the reverberation component. Rotating counter-clockwise: Decreases Rotating clockwise: Increases	① <b>TIME:</b> 0 to 100 ② <b>FREQUENCY:</b> 0 to 100 ③ <b>FEEDBACK:</b> 0 to 100
PITCH ECHO	Outputs delayed sounds repeatedly after the original sound and changes the key and volume of the delayed sounds to achieve a reverberation effect.	Changes the volume of the reverberation component. Rotating counter-clockwise: Decreases Rotating clockwise: Increases	① <b>TIME:</b> 10 to 4,000 ms ② <b>BEAT:</b> 1/32, 1/16, 1/8, 1/4, 1/2, 3/4, 1/1, 2/1, and 4/1 ③ <b>PITCH:</b> -3.0 to 0.0 to +3.0 ④ <b>FEEDBACK:</b> 0 to 90
PITCH	Changes the pitch of the source sound.	Changes the key change amount. Rotating counter-clockwise: Decreases Rotating clockwise: Increases	① <b>PITCH:</b> UP and DOWN
LO-FI	Changes the original sound to a crushed-like sound for output.	Changes the crushing state of sound and cutoff frequency of the filter. Rotating counter-clockwise: Decreases Rotating clockwise: Increases	① <b>REDUCTION:</b> 0 to 100 ② <b>CUT OFF:</b> 0 to 100 ③ <b>RESONANCE:</b> 0 to 100
REVERB	Applies a reverberation effect to the input sound.	Changes the volume and reverberation time of the reverberation component. Rotating counter-clockwise: Decreases Rotating clockwise: Increases	① <b>ROOM SIZE:</b> 1 to 100 ② <b>DAMPING:</b> 0 to 100
PLATE REVERB	Applies a reverberation effect similar to the vibrating of an iron plate to the input sound.	Increases the volume and reverberation time of the reverberation component. Rotating counter-clockwise: Decreases Rotating clockwise: Increases	① <b>ROOM SIZE:</b> 1 to 100 ② <b>DAMPING:</b> 0 to 100

# Adjusting track parameters (TRACK MENU)

You can switch the screen to display the selected track or the details of each setting from the TRACK MENU screen.

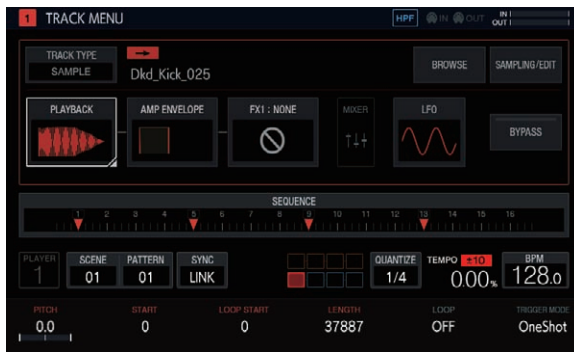

## Setting the track attributes

The track attributes can be set.

If you tap [TRACK TYPE], a pop-up screen appears and you can set one track attribute from four types: [SAMPLE], [THRU], [MIDI], and [TORAIZ AS-1].

For details on each of them, refer to the following.

- **SAMPLE** (Sample track on page 29)
- **THRU** (Through track on page 43)
- **MIDI** (MIDI tracks on page 43)
- **TORAIZ AS-1** (TORAIZ AS-1 tracks on page 46)

## Selecting a module

Any one of the modules can be selected.

The focus is displayed on the selected module. If you tap or turn the rotary selector, the focus moves.

- The parameters in the module with the focus on it can be operated with the parameter adjustment knobs. When the focus is on [BROWSE], [SAMPLING/EDIT], and [SET SCALE], the parameters and parameter flags disappears.

These touch key groups are arranged to make it easy for the user to visualize the flow of sound. Furthermore, the number and types of touch keys displayed here differ depending on the track attribute.

For details on track attributes, refer to *Setting the track attributes* on page 28.

## About display of modulated items

Items such as [PLAYBACK] are displayed highlighted while a 16-step key of a step including modulated parameters is pressed.

- ① The following is an example of when step modulation is performed for [PITCH] (in [PLAYBACK]) and [ATTACK] (in [AMP ENVELOPE]).
- ② Press and hold a 16-step key of a step with a parameter modulated.
- ③ [PLAYBACK] and [AMP ENVELOPE] are highlighted and the parameter name is enclosed with a frame while the key is held down.



## Setting bypass

When you tap [BYPASS], the unit switches to the BYPASS setting mode and the modules in TRACK MENU can be bypassed individually.

- TRACK MENU screen of SAMPLE track

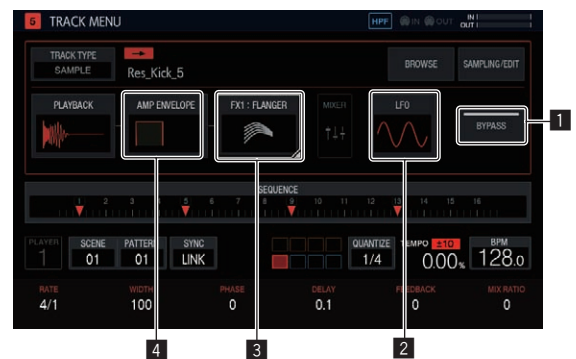

- TRACK MENU screen of THRU track

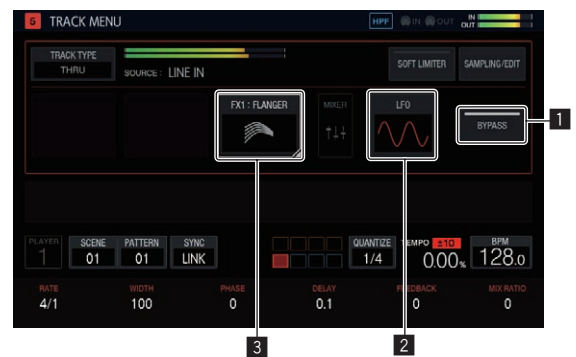

- TRACK MENU screen of MIDI track / TORAIZ AS-1 track

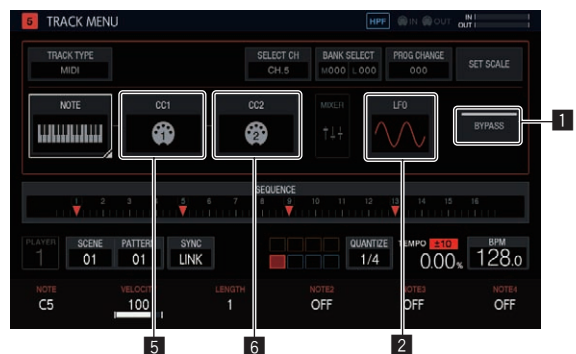

**1 BYPASS**

Each button will function as follows by switching this ON/OFF.  
ON: Switches whether or not to bypass the following (**LFO<sup>2</sup>** to **CC2<sup>6</sup>**) modules.

OFF: Tapping any of the following (**LFO<sup>2</sup>** to **CC2<sup>6</sup>**) module buttons switches to the corresponding setting screen. However, the screen does not switch to a setting screen of a module that is set to be bypassed.

The following explanation is when this is set to ON.

**2 LFO**

Switches whether or not to bypass the **LFO** module settings.

**3 FX1**

Switches whether or not to bypass the **FX1** module settings.

**4 AMP ENVELOPE**

Switches whether or not to bypass the **AMP ENVELOPE** module settings.

**5 CC1**

Switches whether or not to bypass the **CC1** module settings.

**6 CC2**

Switches whether or not to bypass the **CC2** module settings.

The following modules can be bypassed individually.

Track attributes	Modules that can be bypassed
SAMPLE track	AMP ENVELOPE
	FX1
	LFO
THRU track	FX1
	LFO
MIDI track / AS-1 track	CC1
	CC2
	LFO

- The process is being bypassed for a module whose thumbnail image in the touch key is grayed out. Tapping switches whether or not to bypass.

---



---

## Sample track

A sample or sampled sound source can be played. If a sound source is not assigned to a track, nothing is displayed in the sample name field.

---

## Selecting and loading a sample (BROWSE)

You can search for sound sources and assign them to tracks.

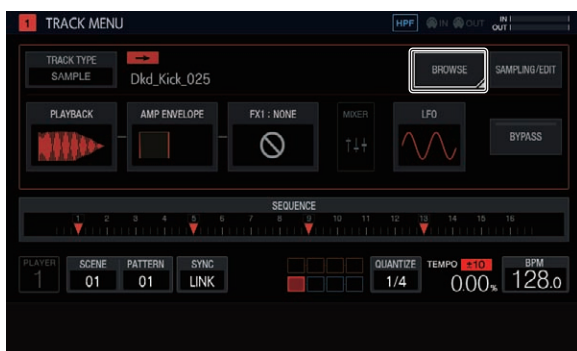

## ❖ SEARCH

If you tap **[SEARCH]**, you can select the filtering method for browsing. Selecting ON/OFF here changes the display content in the right column.

### When set to OFF:

Samples can be filtered by folder level.

- 1 Turn the rotary selector to move the focus.
- 2 The focus can be moved on a folder basis by pressing **[SHIFT]** + turning the rotary selector. (Lines for sample files are skipped.)
- 3 Pressing the rotary selector when a folder is selected opens or closes the folder.
- 4 Select a sample file in a folder while turning the rotary selector.
- 4 Pressing the rotary selector when a sample file is selected assigns the selected sample to the current track.



### When set to ON:

A software keyboard is displayed so that you can search for a sample with a character string.

If you enter characters and then press the **[GO]** button, the search results are displayed. Only samples containing the entered character string are displayed in the list.

A search is always performed within all folders. If you tap **[▲]** or **[▼]**, the search results are sorted in alphabetical ascending order or descending order.

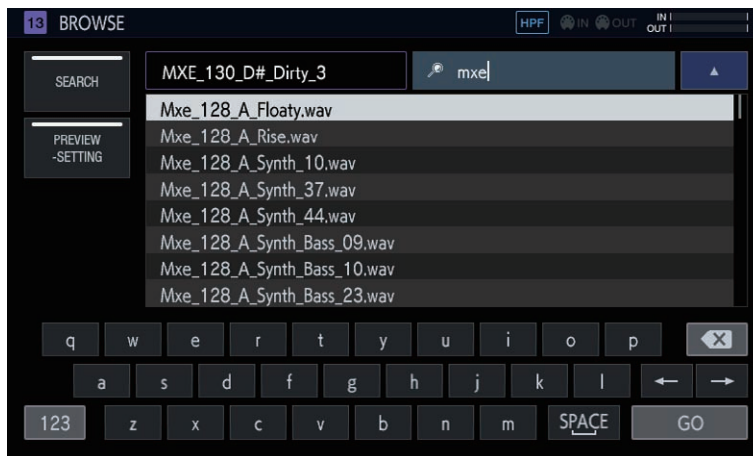



## ❖ PREVIEW (SETTING)

Automatically begins a preview when a sample is selected during browsing. This can be switched ON/OFF by tapping.

When set to ON:

When the rotary selector is turned to move the focus, a selected sample is played only once.

When set to OFF:

Even if the rotary selector is turned to move the focus, samples are not played.

- The default is ON.
- If a sample is selected when this is switched from OFF to ON, it is played only once.

If you press and hold [PREVIEW], you can set various preview settings for browsing.

Option settings	Options
PREVIEW MONITOR	Master + Headphones.Headphones
PREVIEW VOLUME	0-127

- **PREVIEW MONITOR:** Sound output destination for sample preview
- **PREVIEW VOLUME:** Sound volume for sample preview

## ❖ ASSIGNED SAMPLE

Tapping this jumps to the location of the sample assigned to the corresponding track.

- This is not displayed when [SEARCH] is ON.

## ❖ UNLOAD

Unloads the sample that is loaded to the track.

- This is not displayed when [SEARCH] is ON.

## ● Tap [UNLOAD].

The sample is unloaded. When it is unloaded, the sample name displayed at the upper right of the browse screen disappears.

## ❖ DELETE

Deletes a sample.

- This is not displayed when [SEARCH] is ON.

### 1 Turn the rotary selector to select the sample you wish to delete.

### 2 Tap [DELETE].

A confirmation pop-up screen appears.

### 3 Press [OK].

## Recording an external input sound and editing a sample (SAMPLING/EDIT)

You can record an external input sound or a sound output from the unit and edit the waveform of a sample.



### 1 SOURCE

Selects the target for sampling.

The target can be selected from [LINE IN] and [RSMP].

- This cannot be operated while recording.

### 2 REC THRESHOLD

Sets the volume of an input signal for which recording starts automatically.

- This cannot be operated while recording.
- When this is OFF, recording starts instantly.
- When **PLAY**, recording starts at the same time as when the sequencer is started with the [PLAY] button.

### 3 REC LENGTH

Sets the length of time (on a BAR level) to continue recording from the start of recording. This is dependent on the BPM of the sequencer. When the specified length is reached, recording stops automatically.

- This cannot be operated while recording.
- If this is OFF, recording stops automatically when 32 seconds are exceeded after the start of recording.

### 4 SELECTION START

Sets the start point of the selection range.

- This cannot be operated while recording.

### 5 SELECTION END

Sets the end point of the selection range.

- This cannot be operated while recording.

### 6 REC

Enters standby mode for input recording.

Tapping this starts standby, and recording starts if the input signal exceeds [REC THRESHOLD].

- When [REC THRESHOLD] is OFF, the status switches to recording (lit) the moment this button is tapped.

Not standby (off)	Standing by (flashing)	Recording (lit)

If recording is performed in the state in which a sample is already assigned, the waveform is overwritten.

### 7 SOFT LIMITER

A limiter can be applied to the input sound.

## 8 EDIT

Tapping this displays the **EDIT** list.

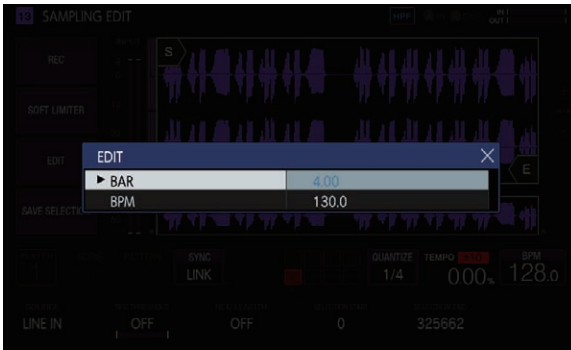

### BAR:

Sets the length (number of bars) of the sample. The value of BPM varies depending on the value that is set here.

### BPM:

Sets the BPM of the sample. The value of BAR varies depending on the value that is set here.

## 9 SAVE CHANGES

Saves the selected range as a sample.

A pop-up window with a name and a consecutive number entered, and a software keyboard appear to enable you to assign a name. The save destination is under PIONEER DJ SAMPLER/Samples/Saved/[Project name].

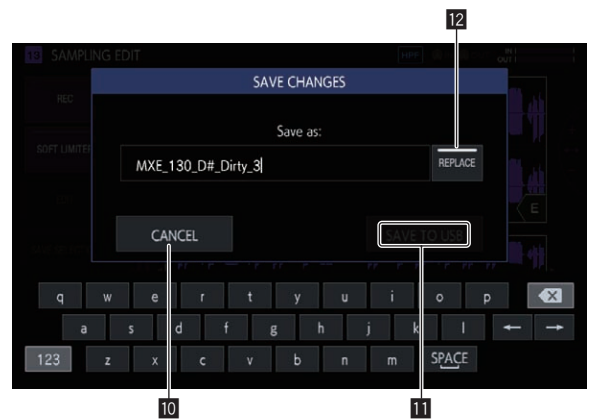

## 10 CANCEL

Closes the pop-up window without saving anything.

## 11 SAVE TO USB

Saves the sample to a USB device and closes the pop-up screen. If a USB device is not connected to the unit, this is grayed out.

## 12 REPLACE

Sets the sample save method.

- When set to ON: Replaces the sample assigned to the track. Select this if you wish to use the saved sample immediately.
- When set to OFF: Keeps the sample assigned to the track. Select this if you wish to cut multiple samples from the same sample and then save them.

## Setting the playback method of a sample (PLAYBACK)

The playback method of the sample assigned to a track can be set.

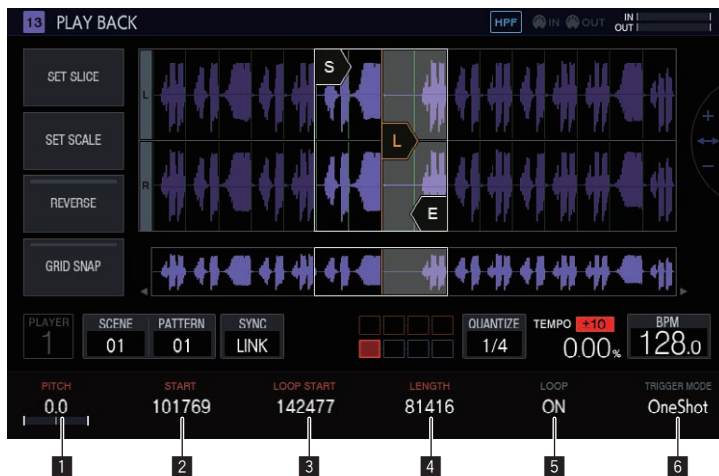

## 1 PITCH

Sets the sound pitch for sample playback. The default is 0.

The setting range varies depending on the **TIME STRETCH** mode.

- **OFF**: -24 to 0 to +24
- **RESMPL**: [PITCH] is disabled, and depends on BPM.
- **M.TMP**: -12 to 0 to +12

## 2 START

Sets the start point of the sample playback range. This is set on the level of the number of Sample.

## 3 LOOP START

When LOOP is ON, the loop start point can be set. This can be set only between [START] and [END].

This is set on the level of the number of Sample.

## 4 LENGTH

Sets the length of the sample playback range. This is set on the level of the number of Sample.

## 5 LOOP

Switches LOOP playback ON/OFF.

- **ON**: When the playback position reaches [END], playback starts again from the position of [LOOP START] set in the same screen.
- **OFF**: When the playback position reaches [END], playback ends at the same time.

## 6 TRIGGER MODE

Switches the method with which a sample is played in response to a trigger.

- **OneShot**: When the performance pad is tapped, the sample is played to the end.
- **GATE**: The sample is played only while the performance pad is pressed.



## ❖ Waveform display area

### Display range

The waveform can be enlarged or reduced horizontally by turning the rotary selector.

- When the START cursor or END cursor is tapped to switch it to the selected state, enlarge or reduce the waveform using the selected cursor as the reference.
- If the selected cursor is tapped again, the selection is canceled. When one of the cursors is selected, tapping the other cursor moves the selection state to the tapped cursor.
- When none of the cursors are selected, enlarge or reduce the waveform using the center of the waveform display area as the reference.

Furthermore, the waveform can be enlarged or reduced vertically by pressing **[SHIFT]** + turning the rotary selector.

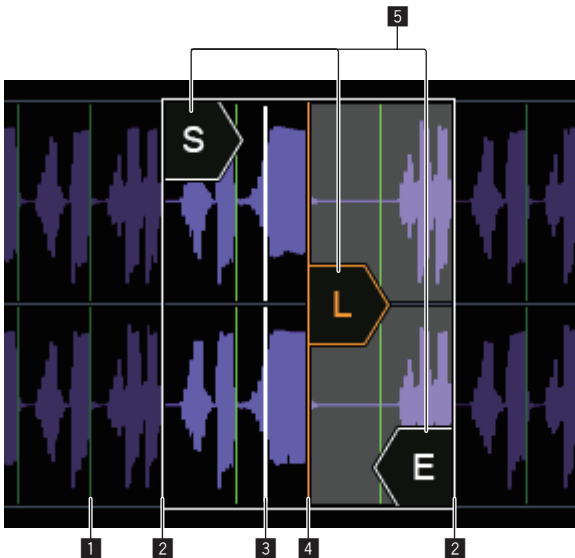

#### 1 SLICE GRID

Displays the SLICE GRID in the background.

#### 2 START/END POINT

Sets the range played when a performance pad is tapped.

#### 3 Playback position

Displays the current playback position.

#### 4 LOOP START POINT

Sets the range that is played repeatedly when LOOP of the track is **[ON]**.  
The loop range is highlighted.

#### 5 START/LOOP START/END cursors

When **[GRID SNAP]** is ON, the range snaps to the GRID.  
The playback range can be finely set with the parameter adjustment knobs.

## ❖ Overall waveform display area

Displays the overall waveform of the assigned sample. The playback range is enclosed in a frame and the loop range is highlighted.

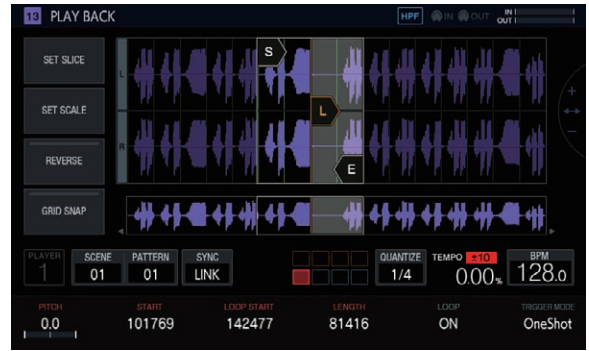

When the area is zoomed in and tapped, the display position jumps to the tapped position.

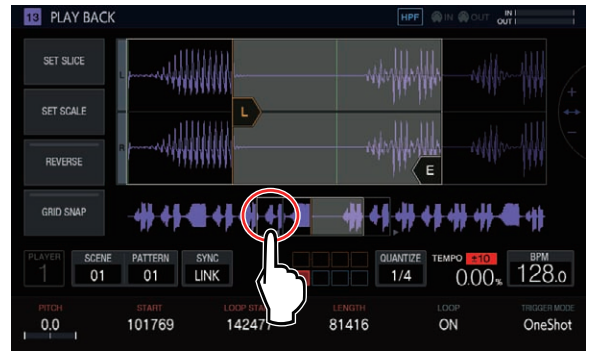

The range displayed changes.

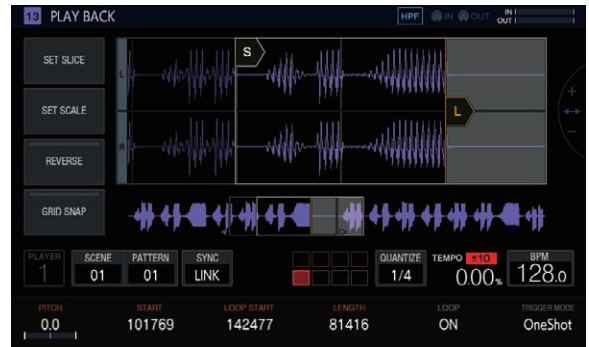

## ❖ GRID SNAP

When [GRID SNAP] is ON, the position of [START], [END], etc. can be set using the GRID position unit specified in [SET SLICE].

When [GRID SNAP] is OFF, the GRID appears thin.

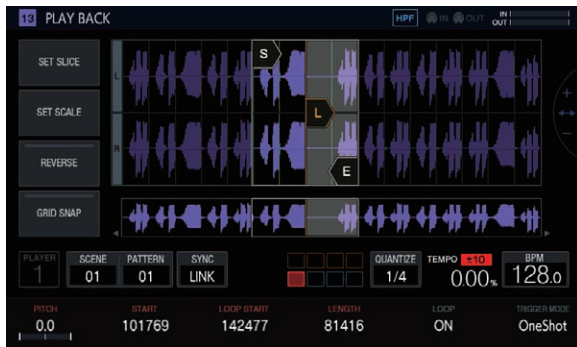

When [GRID SNAP] is ON, the GRID appears thick.

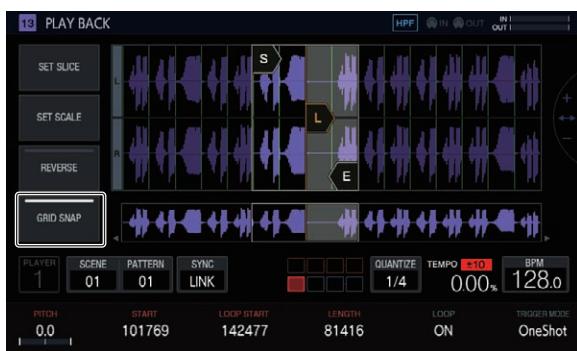

## ❖ REVERSE

Switches reverse playback ON/OFF.

Reverses the playback direction when this button is ON.

### Tap [REVERSE].

Reverse playback is performed.

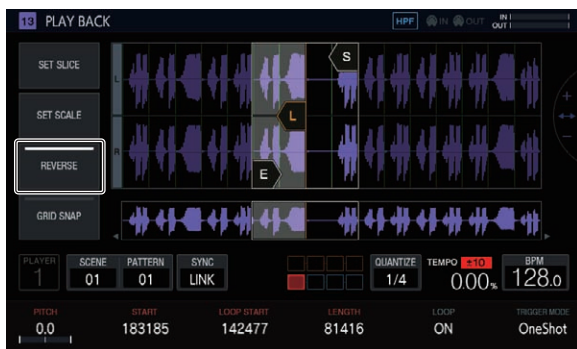

## Setting parameters for slice performances (SET SLICE)

You can add and delete slices, equally slice into a specified number of slices, change the size of each slice, and set the range of the slice to assign to a performance pad.

If you tap **[SET SLICE]** in the **PLAYBACK** screen, the unit switches to the **SET SLICE** screen.

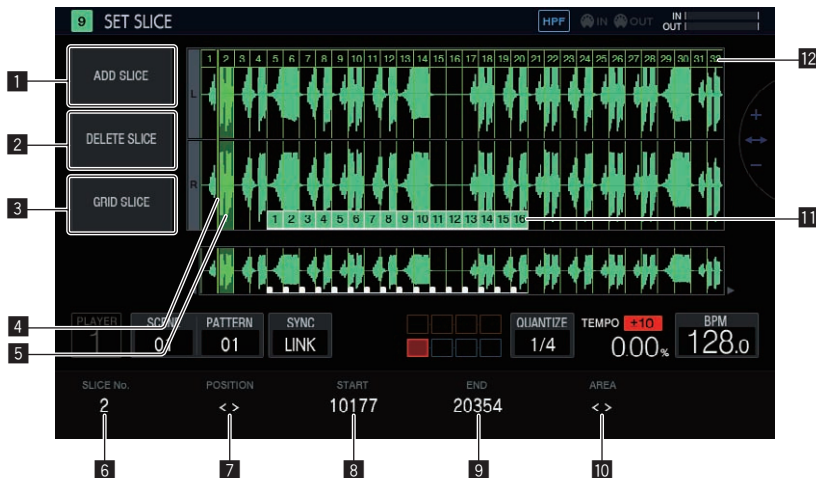

### 1 ADD SLICE

Adds a new slice.

### 2 DELETE SLICE

Deletes the selected slice.

### 3 GRID SLICE

Equally slices into a specified number of slices.

### 4 POSITION display cursor

A green cursor indicates the position selected by **[POSITION]**.

### 5 Selected slice indication

Transparent green on a slice indicates that the slice is selected.

### 6 SLICE No.

Selects a slice.

### 7 POSITION

Moves the selection position.

### 8 START

Sets the start position of the selected slice.

### 9 END

Sets the end position of the selected slice.

### 10 AREA

Sets the start position of the selected slice.

### 11 Pad markers

Pad colors on the slices indicate that the slices are assigned to performance pads.

### 12 Slice markers

A number is assigned and displayed for each slice.

## ❖ Adding a slice

### ● Tap **[ADD SLICE]**.

A new slice is added.

The slice is added with its **POSITION** display cursor as the slice start position. When the slice is added, the SLICE marker numbers are reassigned in order from the beginning.

- When the maximum number of slices (64) has been reached, **[ADD SLICE]** is grayed out and a new slice cannot be added.

## ❖ Deleting a slice

### ● Tap **[DELETE SLICE]**.

The selected slice is deleted.

- When the beginning slice is selected or there is only one slice, **[DELETE SLICE]** is grayed out and the slice cannot be deleted.

## ❖ Equally slicing a sample

### 1 Tap **[GRID SLICE]**.

A pop-up screen for specifying the number of slices appears.

### 2 Turn the rotary selector to select the number of slices and then tap **[OK]**.

The sample is sliced equally with the specified number of slices.

Numbers are assigned to the divided slices in order from the beginning slice, and then displayed on the slice markers.

## ❖ Selecting a slice

### ● Turn the parameter 1 adjustment knob to select a slice.

The number assigned to the slice marker is displayed in **[SLICE No.]**. The selected slice is indicated by transparent green.

## ❖ Setting the slice position

### ● Turn the parameter 2 adjustment knob to move the **POSITION** display cursor.

The slice where the **POSITION** display cursor is located is indicated by transparent green, and its number is displayed in **[SLICE No.]**.

## ❖ Adjusting the slice start position

### ● Turn the parameter 3 adjustment knob to adjust the start position of the selected slice.

This cannot be adjusted for the beginning slice.

## ❖ Adjusting the slice end position

### ● Turn the parameter 4 adjustment knob to adjust the end position of the selected slice.

- This cannot be adjusted for the last slice.

## ❖ Assigning slices to performance pads

### ● Turn the parameter 5 adjustment knob to select the range of the slice to assign to a performance pad.

- The slices assigned to performance pads are indicated with 16 pad markers that have the same color as the track color. The pad markers can specify up to 16 consecutive slices.

## Setting parameters for scale performances (SET SCALE)

If you tap [SET SCALE] in the PLAYBACK screen, the unit switches to the SET SCALE screen.

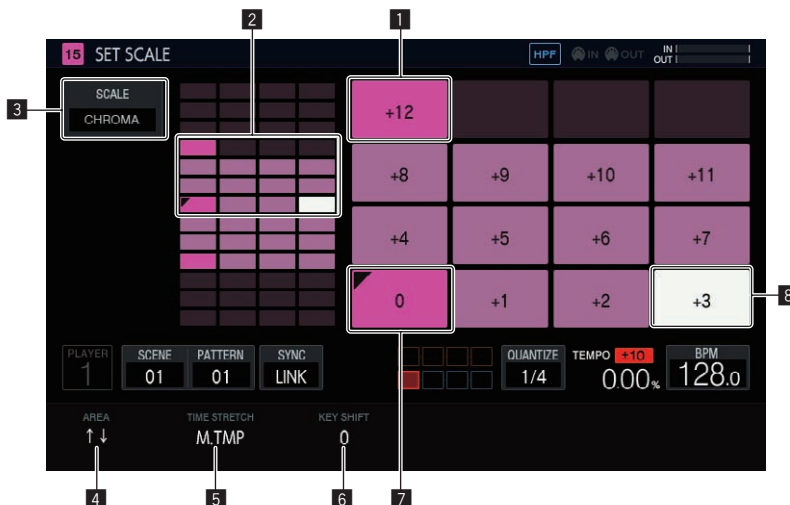

### 1 Octave key

Greater color intensity is used for a key that differs by one octave from the root key. The color differs depending on the track color.

### 2 Pad placement range

Displays the area with sound assigned to the pads.

### 3 SCALE

Sets the scale.

### 4 AREA

Sets the area of the keys assigned to the pads.

### 5 TIME STRETCH

Sets the method of stretching a sample to synchronize with the BPM. This setting is used only when SAMPLE tracks.

### 6 KEY SHIFT

Adjusts the pitch that will be the root key of the scale.

### 7 Root key

Displays the key that will be the root. A triangular mark is added to the top left. The playback pitch of the root key becomes a key that is the sum of the pitch value set on the PLAYBACK screen and the value set in [KEY SHIFT].

### 8 Selected key

Indicates the key selected last with a pad. The key is lit in white. Pressing a 16-step key will input a trigger producing a sound of the same pitch as the sound of the selected key.

Scale name	Abbreviation
Chromatic	CHROMA
Ionian	IONIAN
Dorian	DORIAN
Phrygian	PHRYGIAN
Lydian	LYDIAN
Mixolydian	MIXOLYDYN
Aeolian	AEOLIAN
Locrian	LOCRIAN
Major Pentatonic	M. PENTA
Minor Pentatonic	m. PENTA
Whole Tone	WHOLE T.
Diminish	DIMINISH
Combination Diminish	COMBO D
Altered	ALTERED
Major Blues	M. BLUES
Minor Blues	m. BLUES
Raga Bhairav	RAGA B.
Raga Gamanasrama	RAGA G.
Raga Todi	RAGA T.
Hawaiian	HAWAIIAN
Ryukyu	RYUKYU
Japanese Miyakobushi	JP MIYAKO

## ❖ Setting an area

### ● Turn the parameter 1 adjustment knob.

An area of the pitch of the sounds assigned to the pads can be set. The assigned area can be checked in the pad placement range.

## ❖ Selecting a scale

### 1 Tap [SCALE].

### 2 Turn the rotary selector to select the scale you wish to use and then press the rotary selector.

You can select from the following scales. When a scale is selected, only the sounds of that scale are assigned to the pads.

## ❖ Changing KEY SHIFT

[KEY SHIFT] can be changed. The pitch changed by the changed shift amount becomes the root key. The pitch set in [PITCH] of the PLAYBACK screen is treated as the 0 state for [KEY SHIFT], and changing [KEY SHIFT] shifts the key with respect to that pitch.

- Turn the parameter 3 adjustment knob.

## ❖ Changing TIME STRETCH

Set the method of stretching a sample to synchronize with the BPM. The range that the pitch can be changed in the SCALE mode varies depending on this setting.

### ● Turn the parameter 2 adjustment knob.

- When **OFF**: Enables a scale performance with a pitch of up to  $\pm 24$  halftones.
- When **RESMPL**: Enables a performance only with the root key.
- When **M.TMP**: Enables a scale performance with a pitch of up to  $\pm 12$  halftones.

## Adjusting the change in volume for sample playback (AMP ENVELOPE)

The change in volume can be set for a sample that is played when a performance pad is tapped, a sequence is played, or a trigger is received.

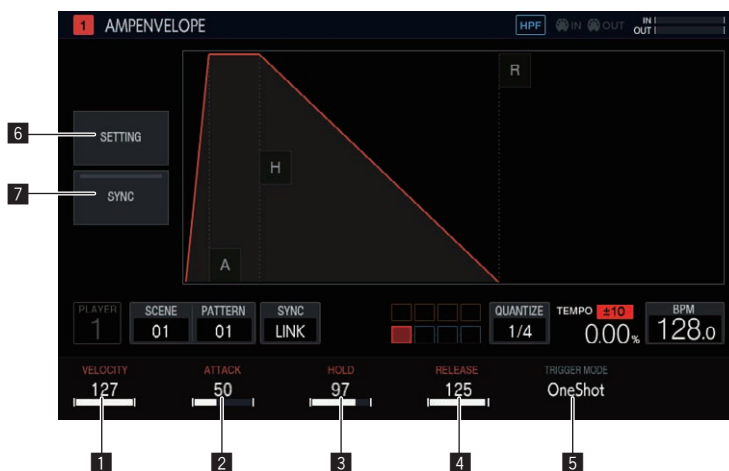

### 1 VELOCITY

Sets the maximum value for the sample playback volume.

### 2 ATTACK

Sets the time from when an on trigger is received to when the volume level becomes the maximum (HOLD is reached). The default is 0. The minimum value is 0 and the maximum value is 32 seconds.



### 3 HOLD

Sets the time from when an on trigger is received to when the volume begins to be attenuated (RELEASE is reached). The default is [INF].

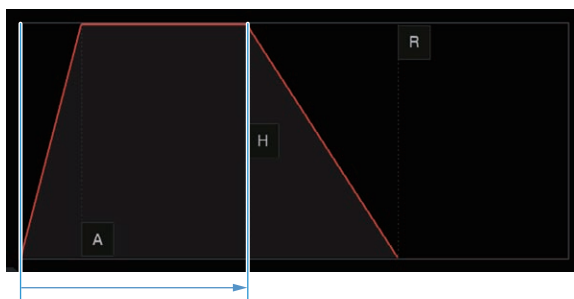

#### 4 RELEASE

Sets the time from when HOLD is passed to when the volume level becomes 0.

The minimum value is 0. The maximum value is 127. When the parameter 4 adjustment knob is turned clockwise even further from the maximum value, the value becomes [INF].

The default is 0.

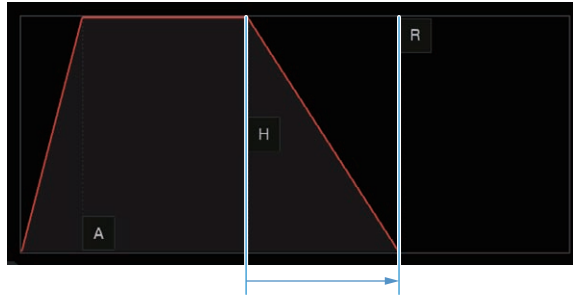

#### 5 TRIGGER MODE

How the envelope operates in response to a trigger can be set. This can be selected from the two options, [OneShot] and [GATE].

**OneShot:**

[A] → [H] → [R] are passed with the on trigger, regardless of the length of time that the performance pad is pressed.

**GATE:**

[A] → [H] → [R] are passed while the performance pad is pressed. When [H] is [INF], moves to [R] with the off trigger.

This is suitable for synthesizer sounds and other sounds that are sustained.

#### 6 SETTING

The AMP ENVELOPE settings can be changed.

**[Attack Curve]:**

The curve for ATTACK can be changed. It can be switched to [Linear] or [Curve].

**[Release Curve]:**

The curve for RELEASE can be changed. It can be switched to [Linear] or [Curve].

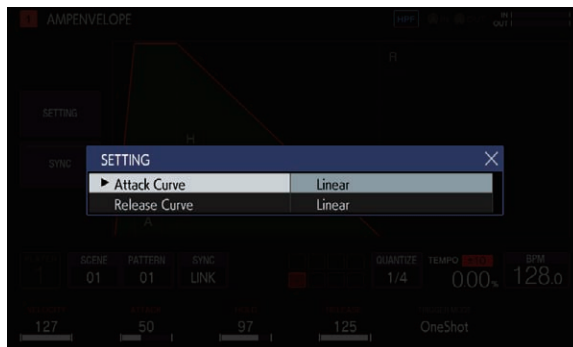

#### 7 SYNC

Whether or not to link the operation of ENVELOPE with the BPM can be set.

The default is OFF.

## Applying effects to tracks (FX1)

Effects can be inserted in tracks.

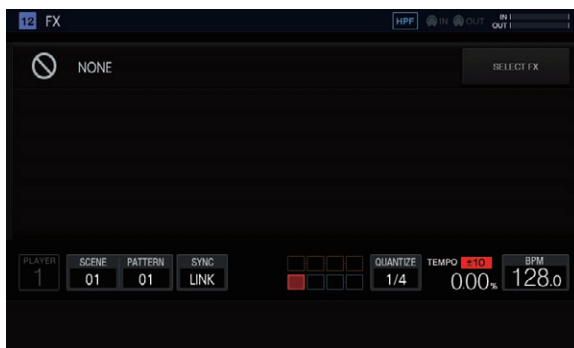

## SELECT FX button

If you tap the [SELECT FX] button, the SELECT FX pop-up screen appears.

Tap the icon of the effect you wish to apply to enter the effect.

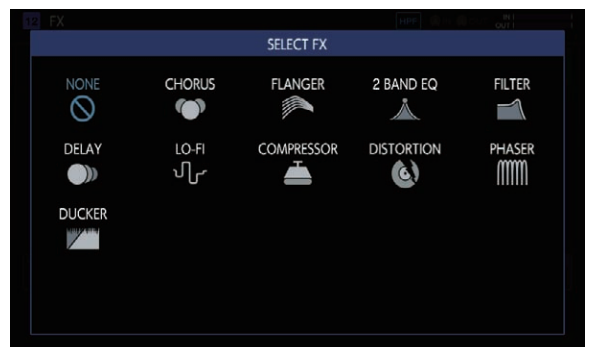

## ❖ Effect display panel

The controls of each FX are displayed in this panel. (Example: CHORUS)

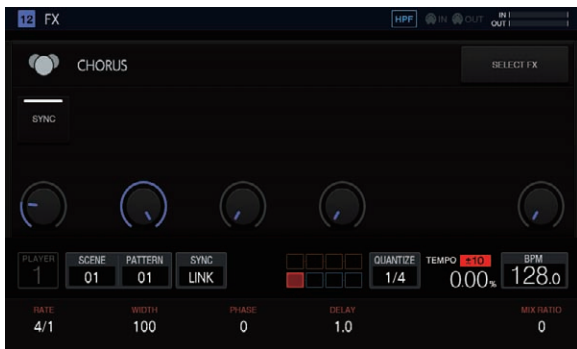

## ❖ About included FX

The following table shows the included FX and the corresponding parameters.

Effect name	Parameter adjustment knobs	Button
2 BAND EQ	(1) <b>B1 Q</b> : 0.1 to 10.0 (2) <b>B1 FREQUENCY</b> : 20 to 20,000 Hz (3) <b>B1 GAIN</b> : -30 to 15 dB (4) <b>B2 Q</b> : 0.1 to 10.0 (5) <b>B2 FREQUENCY</b> : 20 to 20,000 Hz (6) <b>B2 GAIN</b> : -30 to 15 dB	<b>BAND1 TYPE</b> : HPF, LPF, PEAK, HI-SHELF, and LO-SHELF <b>BAND2 TYPE</b> : HPF, LPF, PEAK, HI-SHELF, and LO-SHELF
CHORUS	(1) <b>RATE</b> : 0.1 to 10.0 Hz (When <b>SYNC</b> is ON, 16/1 to 1/16 BEAT) (2) <b>WIDTH</b> : 0 to 100% (3) <b>PHASE</b> : 0 to 180° (4) <b>DELAY</b> : 1.0 to 10.0 ms (6) <b>MIX RATIO</b> : 0 to 100%	<b>SYNC</b> : ON and OFF
COMPRESSOR	(1) <b>RATIO</b> : 1.0:1 to 30.0:1 (2) <b>ATTACK</b> : 0.05 to 1,000 ms (3) <b>RELEASE</b> : 10 to 4,000 ms (4) <b>THRESHOLD</b> : -52 to 0 dB (5) <b>GAIN</b> : 0 to 50 dB (6) <b>MIX RATIO</b> : 0 to 100%	<b>PEAK/RMS</b> : PEAK and RMS <b>SOFT KNEE</b> : ON and OFF
DELAY	(1) <b>TIME</b> : 10 to 1,000 ms (When <b>SYNC</b> is ON, 1/8 to 2/1 BEAT) (2) <b>FEEDBACK</b> : 0 to 100% (3) <b>HI CUT</b> : 0 to 100 (6) <b>MIX RATIO</b> : 0 to 100%	<b>SYNC</b> : ON and OFF
DISTORTION	(1) <b>DRIVE</b> : 0.0 to 40.0 (2) <b>LO FREQ</b> : 20 to 20,000 Hz (3) <b>HI FREQ</b> : 20 to 20,000 Hz (4) <b>DYNAMICS</b> : 0 to 100% (5) <b>STONE</b> : 20 to 20,000 Hz (6) <b>MIX RATIO</b> : 0 to 100%	
DUCKER	(1) <b>ATTACK</b> : 0 to 1,000 ms (When <b>SYNC</b> is ON: 0.00 to 4.00 steps) (2) <b>CURVE (ATTACK)</b> : -100 to 100% (3) <b>RELEASE</b> : 0.1 to 8,000.0 ms (When <b>SYNC</b> is ON, 0.25 to 32.00 steps) (4) <b>CURVE (RELEASE)</b> : -100 to 100% (6) <b>DEPTH</b> : 0 to 100%	<b>SYNC</b> : ON and OFF <b>SOURCE</b> : From TRACK1TRACK16

Effect name	Parameter adjustment knobs	Button
FLANGER	(1) <b>RATE</b> : 0.01 to 1.00 Hz (When <b>SYNC</b> is ON, 64/1 to 1/1 BEAT) (2) <b>WIDTH</b> : 0 to 100% (3) <b>PHASE</b> : 0 to 180° (4) <b>DELAY</b> : 0.1 to 7.0 ms (5) <b>FEEDBACK</b> : 0 to 99% (6) <b>MIX RATIO</b> : 0 to 100%	<b>SYNC</b> : ON and OFF
LO-FI	(1) <b>PREAMP</b> : 0 to +42 dB (2) <b>REDUCTION</b> : 44 to 44,100 Hz (3) <b>BIT DEPTH</b> : 1 to 16, 24, and OFF (4) <b>CUT OFF</b> : 20 to 20,000 Hz (5) <b>RESONANCE</b> : 0.2 to 10.0 (6) <b>MIX RATIO</b> : 0 to 100%	<b>TYPE</b> : HPF, LPF, BPF, and OFF <b>PRE/POST</b> : PRE and POST
MULTI MODE FILTER	(1) <b>CUT OFF</b> : 20 to 20,000 Hz (2) <b>GAIN</b> : -30 to 15 dB (3) <b>RESONANCE</b> : 0.2 to 10.0 (4) <b>GLIDE</b> : 0 to 100 (6) <b>MIX RATIO</b> : 0 to 100%	<b>TYPE</b> : HPF, LPF, and BPF <b>SLOPE</b> : 12 dB/oct, 24 dB/oct
PHASER	(1) <b>RATE</b> : 0.01 to 1.00 Hz (When <b>SYNC</b> is ON, 64/1 to 1/1 BEAT) (2) <b>WIDTH</b> : 0 to 100% (3) <b>PHASE</b> : 0 to 180° (4) <b>FREQUENCY</b> : 300.0 to 18,000 Hz (5) <b>FEEDBACK</b> : 0 to 99% (6) <b>MIX RATIO</b> : 0 to 100%	<b>SYNC</b> : ON and OFF

## Setting LFO (LFO)

Apply changes to the pitch and tone with LFO for a parameter of each track to enable a performance with a modulation effect.

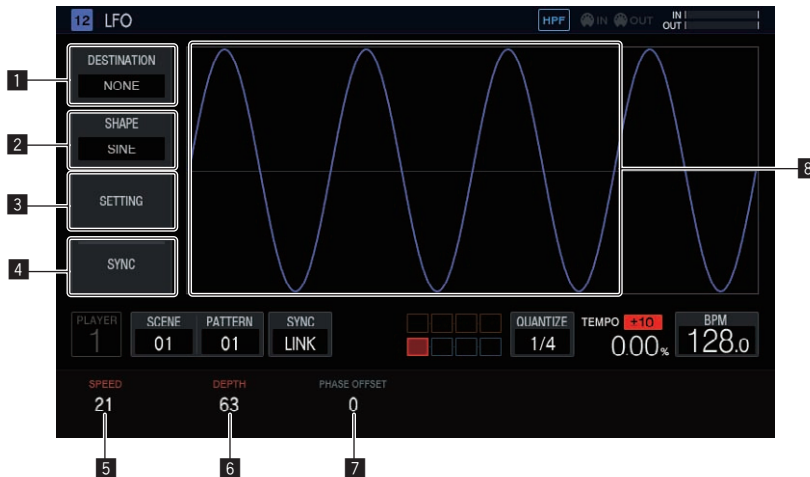

### 1 DESTINATION

Selects the parameter for which to apply the modulation effect with LFO.

### 2 SHAPE

Selects the shape of LFO.

### 3 SETTING

Sets the detailed operation of LFO.

### 4 SYNC

Selects ON/OFF for STEP sync of the **SPEED** parameter.

### 5 SPEED

Sets the frequency of LFO.

### 6 DEPTH

Sets the application amount that LFO applies to the parameter.

### 7 PHASE OFFSET

Sets the start phase of the waveform of LFO.

### 8 LFO waveform display

Displays an LFO waveform in accordance with the [SHAPE], [DEPTH], and [PHASE OFFSET] setting values.

## ❖ Selecting the target parameter

### ● Tap [DESTINATION].

Select the parameter for modulation with LFO. One parameter can be selected per track.

Category name	Parameter name
PLAYBACK	PITCH
	START
	LOOP START
	LENGTH
AMP ENVELOPE	VELOCITY
	ATTACK
	HOLD
	RELEASE



Category name	Parameter name
FX1	2 BAND EQ B1 Q
	2 BAND EQ B1 FREQUENCY
	2 BAND EQ B1 GAIN
	2 BAND EQ B2 Q
	2 BAND EQ B2 FREQUENCY
	2 BAND EQ B2 GAIN
	CHORUS RATE
	CHORUS WIDTH
	CHORUS PHASE
	CHORUS DELAY
	CHORUS MIX RATIO
	COMPRESSOR RATIO
	COMPRESSOR ATTACK
	COMPRESSOR RELEASE
	COMPRESSOR THRESHOLD
	COMPRESSOR OUTPUT GAIN
	COMPRESSOR MIX RATIO
	DELAY TIME
	DELAY FEEDBACK
	DELAY HI CUT
	DELAY MIX RATIO
	DISTORTION DRIVE
	DISTORTION LO FREQ
	DISTORTION HI FREQ
	DISTORTION DYNAMICS
	DISTORTION TONE
	DISTORTION MIX RATIO
	DUCKER ATTACK
	DUCKER CURVE (ATTACK)
	DUCKER RELEASE
	DUCKER CURVE (RELEASE)
	DUCKER DEPTH
	FLANGER RATE
	FLANGER WIDTH
	FLANGER PHASE
	FLANGER DELAY
	FLANGER FEEDBACK
	FLANGER MIX RATIO
	LO-FI PREAMP
	LO-FI REDUCTION
	LO-FI BIT DEPTH
	LO-FI CUTOFF
LO-FI RESONANCE	
LO-FI MIX RATIO	
MULTI MODE FILTER CUTOFF	
MULTI MODE FILTER GAIN	
MULTI MODE FILTER RESONANCE	
MULTI MODE FILTER GLIDE	
MULTI MODE FILTER MIX RATIO	
PHASER RATE	
PHASER WIDTH	
PHASER PHASE	
PHASER FREQUENCY	
PHASER FEEDBACK	
PHASER MIX RATIO	
MIDI NOTE	VELOCITY
	LENGTH

Category name	Parameter name
MIDI CC1	PARAMETER 1 PITCH BEND
	PARAMETER 2 AFTER TOUCH
	PARAMETER 3
	PARAMETER 4
	PARAMETER 5
	PARAMETER 6
MIDI CC2	PARAMETER 1
	PARAMETER 2
	PARAMETER 3
	PARAMETER 4
	PARAMETER 5
	PARAMETER 6
MIXER	VOLUME
	PAN

- Even if a target parameter is selected, the LFO effect will not be applied if an effect, MIDI track, etc. including that parameter is not assigned.

### ❖ Selecting the LFO waveform shape

#### ● Tap [SHAPE] and select the LFO waveform shape.

There are seven LFO waveform shape types: [SINE], [TRIANGLE], [SAW], [SQUARE], [PULSE25], [PULSE12], and [RANDOM]. A waveform of the selected shape is displayed in the LFO waveform display section.

- [RANDOM] generates a new RANDOM shape each time the shape is switched from a different shape.



### ❖ Setting the detailed operation of LFO

If you tap [SETTING], the detailed operation setting pop-up screen appears. Set **Mode** and **Trigger On** in this screen.

#### Mode

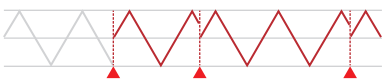
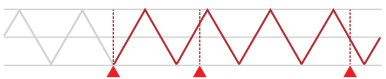
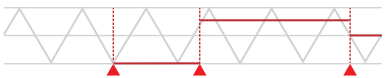
Select the LFO operation for a trigger. Three types of Mode are available: **Trigger**, **Free**, and **Sample & Hold**. The operation is as follows when each of them is selected.

Mode	Operation
Trigger	LFO restarts with each trigger. 
Free	Oscillation always occurs in the background regardless of triggers. 
Sample & Hold	Oscillation always occurs in the background but the value at the time of a trigger is retained. 

-  Trigger
-  Applied parameter
-  LFO oscillating in the background

#### Trigger On

In the Mode setting, select the type of trigger of the sequencer for which the LFO trigger operates.

- **Full:** The LFO trigger operates only for a Full trigger.
- **Full & Half:** The LFO trigger operates for a Full trigger or a Half trigger.

## ❖ Setting the various parameters of LFO

Turn the parameter adjustment knobs to set the values of **[SPEED]**, **[DEPTH]**, and **[PHASE OFFSET]**. An explanation and the setting range of each parameter are provided below.

### SPEED

Turn the parameter 1 adjustment knob to set the frequency of LFO. The setting range will vary as follows depending on whether the **[SYNC]** button is ON or OFF.

- **SYNC** When OFF: 0 to 127
- **SYNC** When ON: 1/2, .1, 2, 3, 4, 8, 12, 16, 32, 48, 64, 128 (unit: **STEP**)

### DEPTH

Turn the parameter 2 adjustment knob to set the application amount to apply to the parameter selected in **[DESTINATION]**. The range is -64 to 0 to 63.

- When the **DEPTH** value is a minus value, the top and bottom of the waveform will be inverted.
- A waveform is displayed in the LFO waveform display section in accordance with the **DEPTH** value.

### PHASE OFFSET

Turn the parameter 3 adjustment knob to set the initial position of LFO. The range is 0% to 99%.

- The initial position of LFO at 99% will be delayed by about 1 cycle.
- A waveform is displayed in the LFO waveform display section in accordance with the **PHASE OFFSET** value.

## Adjusting various trigger sequences (SEQUENCE)

The trigger sequence of each track can be offset and otherwise adjusted with a unit smaller than steps.

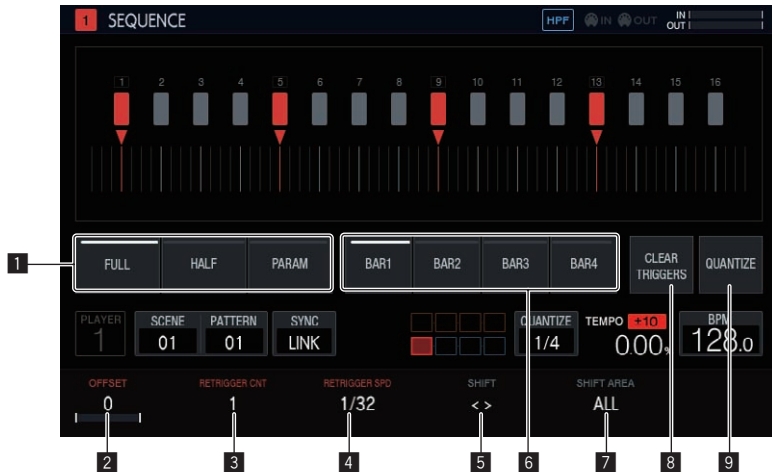

### 1 Trigger type selection

Selects the type of triggers to input. The default is **[FULL]**.

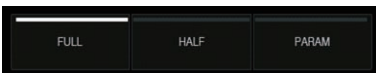

- ① Full trigger (**Full**)  
SAMPLE, ENVELOPE, and all modulated parameters are triggered.
- ② Half trigger (**HALF**)  
ENVELOPE and modulated parameters are triggered.
- ③ Parameter trigger (**PARAM**)  
Only modulated parameters are triggered.

### 2 OFFSET

A trigger can be finely adjusted forward or backward. It can be adjusted up to  $\pm 1$  step (indicating line is directly below the adjacent step).

Move the trigger position **[▼]** on the touch display a very small amount by operating this parameter.

- The default is 0.

### 3 RETRIGGER CNT

Sets the number of times to input triggers repeatedly over a short period.

- The default is 1.
- When **[RETRIGGER CNT]** is two or more, the **[▼]** mark on the screen is changed to the mark for indicating repeated input (two **[▼]** marks arranged vertically).

### 4 RETRIGGER SPD

Sets the speed for re-triggering.

- The default is 1/32 (BAR).
- When **[RETRIGGER CNT]** is two or more, the **[▼]** mark on the screen is changed to the mark for indicating repeated input (two **[▼]** marks arranged vertically).

### 5 SHIFT

An input trigger can be offset by step (circle shift) within the range set in **[SHIFT AREA]**.

### 6 BAR

This is linked to the bar selection button and the bar to be displayed can be selected. It also indicates the bar currently displayed.

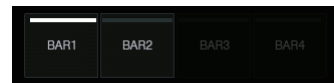

### 7 SHIFT AREA

Sets the range to apply **[SHIFT]**.

This can be selected from the two types, **[BAR]** and **[ALL]**.

- Specify the operation target step with the hardware buttons. When no step has been specified, all steps become targets. For example, all steps are uniformly offset in the case of an offset. When an individual step is selected by pressing a step key, the corresponding vertically long **[■]** and **[▼]** on the touch display flash.

### 8 CLEAR TRIGGERS

Clears all of the triggers input to the currently selected pattern.

### 9 QUANTIZE

Snaps the triggers input to the currently selected pattern on a 1/16 level.

❖ **Clearing all triggers****1 Tap [CLEAR TRIGGERS].**

A confirmation message appears.

**2 Tap [OK].**

Clears all of the triggers input to the currently selected pattern.

- If you tap [CANCEL], the pop-up screen closes without clearing and the sequence screen reappears.

❖ **Quantize**

This feature can be used when aligning triggers that were input with, for example, dynamic recording to steps.

● **Tap [QUANTIZE].**

Any input triggers that are offset from steps are quantized to a step in the vicinity on a 1/16 level.

---



---

## Through track

The [LINE IN] external input can be assigned to a track to apply an effect. Select the input source with the parameter adjustment knobs below the touch display and adjust [INPUT LEVEL] on the top panel of the unit or the volume level of the source device while looking at INPUT MONITOR. At that time, if [SOFT LIMIT] (ON/OFF toggle operation) is tapped, the analog limiter at the input stage is enabled to reduce unnecessary clipping.



---



---

## MIDI tracks

Performances with the unit and using external MIDI sound sources according to the MIDI sequence are possible.

---



---

## Connections

❖ **Connecting with DIN MIDI**

**1 Connect the MIDI IN terminal of the external MIDI device and the MIDI OUT/THRU terminal of this unit with a MIDI cable.**

**2 Tap [SYNC] in the HOME screen, etc. to display the SYNC screen.**

**3 Tap [DIN MIDI] in MIDI I/F SELECT.**

After configuring the above setting, tap [TRACK TYPE] in the TRACK MENU screen of the track you wish to use for the MIDI performance and then use the rotary selector to select [MIDI].

❖ **Connecting with USB MIDI**

**1 Connect your computer and the USB-B terminal of this unit with a USB cable.**

**2 Tap [SYNC] in the HOME screen, etc. to display the SYNC screen.**

**3 Tap [USB MIDI] in MIDI I/F SELECT.**

After configuring the above setting, tap [TRACK TYPE] in the TRACK MENU screen of the track you wish to use for the MIDI performance and then use the rotary selector to select [MIDI].

- For the detailed settings of the MIDI notes and MIDI control changes to be transmitted with MIDI tracks, refer to *Setting MIDI NOTE (MIDI NOTE)* on page 46 and *Setting MIDI CC (MIDI CC1/CC2)* on page 44.

❖ **Setting whether or not to transmit various MIDI messages**

Configure the settings for whether or not to transmit various MIDI messages in the **PROJECT SETTING (MIDI OUT)** category of the UTILITY screen. The setting items and setting values are as follows.

Option settings	Options
CLOCK	ENABLE/DISABLE

- **ENABLE:** Transmits **MIDI CLOCK** to the external MIDI device based on the BPM of the unit's sequencer.
- **DISABLE:** Does not transmit **MIDI CLOCK** to the external MIDI device.

Option settings	Options
START/STOP/CONTINUE	ENABLE/DISABLE

- **ENABLE:** Transmits the **START**, **STOP**, and **CONTINUE** messages to the external MIDI device.
- **DISABLE:** Does not transmit the **START**, **STOP**, and **CONTINUE** messages to the external MIDI device.

Option settings	Options
NOTE/CC	ENABLE/DISABLE

- **ENABLE:** Transmits **NOTE** and **CC** (including **Pitch Bend** and **After Touch**) to the external MIDI device.
- **DISABLE:** Does not transmit **NOTE** and **CC** (including **Pitch Bend** and **After Touch**) to the external MIDI device.

Option settings	Options
SONG POSITION	ENABLE/DISABLE

- **ENABLE:** Transmits the song position pointer to the external MIDI device.
- **DISABLE:** Does not transmit the song position pointer to the external MIDI device.

❖ **Setting the MIDI OUT channel**

To set the MIDI OUT channel setting, tap [SELECT CH] in the TRACK MENU screen of the MIDI track to be transmitted to the MIDI. Then, set CH from the displayed pop-up screen.

To reset the set MIDI OUT channel, execute [CHANNEL MAPPING RESET] in the **PROJECT SETTING (MIDI OUT)** category of the UTILITY screen.

Option settings	Options
CHANNEL MAPPING RESET	None (Executes RESET.)

The MIDI CH set in the TRACK MENU screen is reset. When a reset is performed, the track number and MIDI CH are restored to the initial values of the same number.

- TRACK1 to TRACK16: CH.1 to CH.16

## Setting MIDI NOTE (MIDI NOTE)

Set the MIDI notes to transmit when the pads of a MIDI track are pressed or when triggered in a sequence. Up to four MIDI notes can be triggered by setting a harmony in addition to a base note.

You can input MIDI note triggers to the step sequencer in the same manner as a sample track or you can perform dynamic recording of your pad performance.

- The SLICE mode cannot be used with a MIDI track.

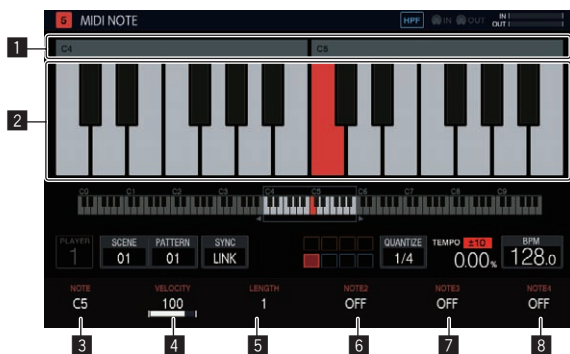

### 1 Octave number display

Displays the octave number. Displays from C0 to C9.

### 2 Keyboard display

Indicates the notes set in [NOTE] with the track color. Indicates the notes set in [NOTE2], [NOTE3], and [NOTE4] with a lighter version of the track color.

### 3 NOTE

Changes the note number. The range is C0 to B9.

### 4 VELOCITY

Change the velocity. The range is OFF and 1 to 127.

### 5 LENGTH

Changes the length. The range is 0.25 step to 64 steps.

### 6 NOTE2

Changes a note of chords based on the note number set in [NOTE]. The range is -127 to OFF to +127.

### 7 NOTE3

Changes a note of chords based on the note number set in [NOTE]. The range is -127 to OFF to +127.

### 8 NOTE4

Changes a note of chords based on the note number set in [NOTE]. The range is -127 to OFF to +127.

If you use the TRANSPOSE function of HOME > TRACK MENU > SEQUENCE, you can shift an entire note output from a MIDI track in half-tones. Turn the parameter 6 adjustment knob to change [TRANSPOSE] in the SEQUENCE screen.

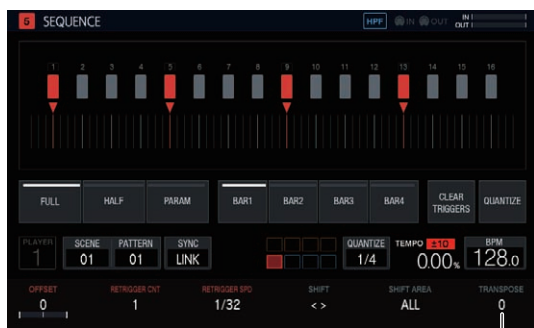

### 1 TRANSPOSE

Changes the transpose value. The range is -24 to +24.

## Setting MIDI CC (MIDI CC1/CC2)

Set the MIDI control changes to transmit when the pads of a MIDI track are pressed or when triggered in a sequence.



### 1 CC number selection

Changes the control change numbers of [PARAMETER 1] to [PARAMETER 6].

- [PITCH BEND] of [PARAMETER 1] and [AFTER TOUCH] of [PARAMETER 2] cannot be changed in the CC1 setting screen.

### 2 ACTIVE

Switches [PARAMETER 1] to [PARAMETER 6] between active and non-active.

### 3 CC values

Changes the control change values of [PARAMETER 1] to [PARAMETER 6].

## Setting bank selection and program change

Bank selection and program change messages can be transmitted when using MIDI tracks (or TORAIZ AS-1 tracks).

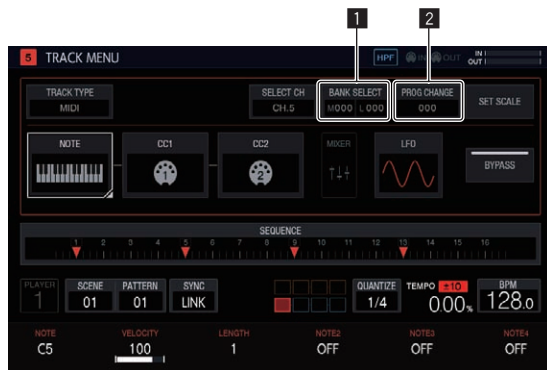

### 1 BANK SELECT

Changes the bank value to transmit.

### 2 PROG CHANGE

Changes the program change value to transmit.

## ❖ Transmitting the bank selection

### 1 Tap [BANK SELECT] in the TRACK MENU screen of the MIDI track.

Tap the MSB area if you wish to change MSB (M), and the LSB area if you wish to change LSB (L).

### 2 Turn the rotary selector to set the value you wish to set.

### 3 Tap [OK].

The value is entered and the pop-up screen closes. The set value is displayed in [BANK SELECT].

## ❖ Transmitting the program change

### 1 Tap [PROG CHANGE] in the TRACK MENU screen of the MIDI track.

### 2 Turn the rotary selector to set the value you wish to set.

### 3 Tap [OK].

The value is entered and the pop-up screen closes. The set value is displayed in [PROG CHANGE].

- The bank selection and program change values can be set for each SCENE. The program of the external MIDI device can be changed in conjunction with the SCENE switching operation.

## Setting parameters for scale performances (SET SCALE)

If you tap the [SET SCALE] button in the TRACK MENU screen, the unit switches to the SET SCALE screen.

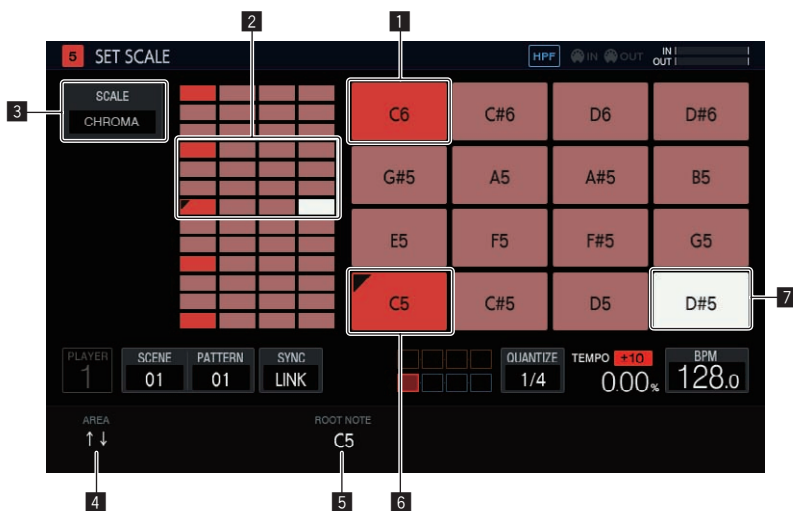

### 1 Octave key

Greater color intensity is used for a key that differs by one octave from the root key. The color differs depending on the track color.

### 2 Pad placement range

Displays the area with sound assigned to the pads.

### 3 SCALE

Sets the scale.

### 4 AREA

Sets the area of the keys assigned to the pads.

### 5 ROOT NOTE

Adjusts the pitch that will be the root key of the scale.

### 6 Root key

Displays the key that will be the root. A triangular mark is added to the top left.

The name of the sound set in [ROOT NOTE] is displayed.

### 7 Selected key

Indicates the key selected last with a pad. The key is lit in white. Pressing a 16-step key will input a trigger producing a sound of the same pitch as the sound of the selected key.

## ❖ Selecting a scale

### 1 Tap [SCALE].

### 2 Turn the rotary selector to select the scale you wish to use and then press the rotary selector.

For the scales that can be selected, refer to the table in *Selecting a scale* on page 36.

## ❖ Setting an area

### ● Turn the parameter 1 adjustment knob.

An area of the pitch of the sounds assigned to the pads can be set. The assigned area can be checked in the pad placement range.

## ❖ Changing ROOT NOTE

### ● Turn the parameter 3 adjustment knob.

[ROOT NOTE] can be changed. The changed sound becomes the root key, and is indicated at the top of the parameter 3 adjustment knob.

## TORAIZ AS-1 tracks

These are dedicated track attributes that are convenient for performances with a TORAIZ AS-1 analog synthesizer connected to [MIDI OUT].

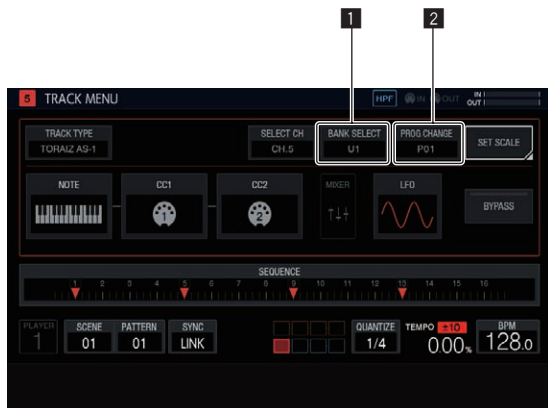

### 1 BANK SELECT

Changes the bank value stored in the preset.

### 2 PROG CHANGE

Changes the program change value to transmit.

## Connections

1 Connect the MIDI IN terminal of the TORAIZ AS-1 and the MIDI OUT/THRU terminal of this unit with a MIDI cable.

2 Tap [SYNC] in the HOME screen, etc. to display the SYNC screen.

3 Tap [DIN MIDI] in MIDI I/F SELECT.

4 Set MIDI Channel to ALL or any channel, MIDI Param Rcv to CC, and MIDI Control Enable to On in [GLOBAL SETTING] of the TORAIZ AS-1 unit.

After configuring the above settings, tap [TRACK TYPE] in the TRACK MENU screen of the track you wish to use for the MIDI performance and then use the rotary selector to select [TORAIZ AS-1].

## Setting MIDI NOTE (MIDI NOTE)

[MIDI NOTE] can be set in the same way as with a MIDI track. However, [NOTE2], [NOTE3], and [NOTE4] cannot be set because the TORAIZ AS-1 does not support chords.

## Setting MIDI CC (MIDI CC1/CC2)

If you tap [CC1] or [CC2], the unit switches to the screen for setting the MIDI CC compatible parameters of the TORAIZ AS-1.



### 1 CC number selection

Changes the control change numbers of [PARAMETER 1] to [PARAMETER 6].

- [PITCH BEND] of [PARAMETER 1] and [AFTER TOUCH] of [PARAMETER 2] cannot be changed in the CC1 setting screen.

### 2 ACTIVE

Switches [PARAMETER 1] to [PARAMETER 6] between active and non-active.

### 3 CC values

Changes the control change values of [PARAMETER 1] to [PARAMETER 6].

## Switching the preset

Bank selection and program change can be used to select the program of the AS-1.

### 1 Tap [BANK SELECT].

- When using program change, tap [PROG CHANGE].

2 Turn the rotary selector to select the bank containing the preset you wish to call out and then press the rotary selector.

The bank is entered. Select a bank from the following.

- [U1] to [U5]: User banks
- [F1] to [F5]: User banks
- When using program change, use the rotary selector to select the program you wish to call out and then press the rotary selector to enter the program.
- The bank selection and program change values can be set for each scene.

## Setting parameters for scale performances (SET SCALE)

Refer to *Setting parameters for scale performances (SET SCALE)* on page 45.

# Changing the settings (UTILITY)

Various settings of the unit can be configured.

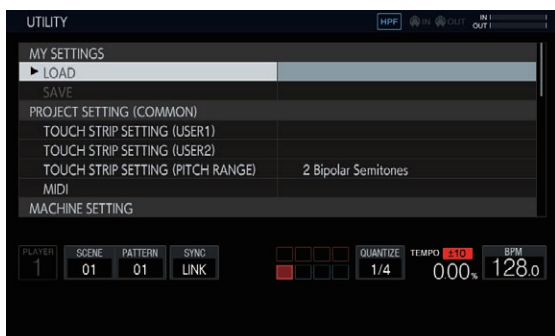

- 1 Press and hold the [HOME/UTILITY/WAKE UP] button. The UTILITY screen appears.
- 2 Turn the rotary selector to select the item to set. The focus moves.
- 3 Press the rotary selector to enable changing the settings. The focus moves to the setting value.
- 4 Turn the rotary selector to change the setting value.
- 5 Press the rotary selector to enter the setting value. The focus moves to the setting item.
  - If the [BACK] button is pressed during the process, the setting value will not be changed.

## Setting preferences

Option settings		Setting ranges	Descriptions	
MY SETTINGS	LOAD	-	Calls setting details recorded on recording media.	
	SAVE	-	Records the setting details on recording media.	
PROJECT SETTING	TOUCH STRIP SETTING (USER1)		Configure the settings of touch strip mode [USER1]. ⤵ Setting the USER mode of the touch strip (TOUCH STRIP SETTING) (p.49)	
	TOUCH STRIP SETTING (USER2)		Configure the settings of touch strip mode [USER2]. ⤵ Setting the USER mode of the touch strip (TOUCH STRIP SETTING) (p.49)	
	TOUCH STRIP SETTING (PITCH RANGE)		2 Bipolar Semitones*, 4 Bipolar Semitones, 12 Bipolar Semitones	Configure the range of the PITCH mode of the touch strip.
	MIDI	MIDI IN	CLOCK	ENABLE*/DISABLE ⤵ Setting whether or not to receive various MIDI messages (p. 52)
			START/STOP/CONTINUE	ENABLE*/DISABLE ⤵ Setting whether or not to receive various MIDI messages (p. 52)
			NOTE/CC	ENABLE*/DISABLE ⤵ Setting whether or not to receive various MIDI messages (p. 52)
			CHANNEL MAPPING	- ⤵ Setting the MIDI IN channel (p. 52)
			CHANNEL MAPPING RESET	- ⤵ Setting the MIDI IN channel (p. 52)
		MIDI OUT	CLOCK	ENABLE*/DISABLE ⤵ Setting whether or not to transmit various MIDI messages (p. 43)
			START/STOP/CONTINUE	ENABLE*/DISABLE ⤵ Setting whether or not to transmit various MIDI messages (p. 43)
NOTE/CC			ENABLE*/DISABLE ⤵ Setting whether or not to transmit various MIDI messages (p. 43)	
CHANNEL MAPPING RESET			- ⤵ Setting the MIDI OUT channel (p. 43)	
SONG POSITION			ENABLE*/DISABLE ⤵ Setting whether or not to transmit various MIDI messages (p. 43)	



Option settings		Setting ranges	Descriptions
MACHINE SETTING	PAD CURVE	Hard 3, Hard 2, Hard 1, Linear*, Soft 1, Soft 2, Soft 3	Set the volume curve characteristics (velocity curve) in response to the strength that a pad is pressed.
	PAD THRESHOLD	1(Low) to 5(Default)* to 16(High)	Set the strength at which the pad must be pressed to start outputting sound.
	PAD SENCITIVITY	1(Heavy) to 5(Default)* to 16(Light)	Set the strength at which the pad must be pressed to output sound at the maximum volume level.
	METRONOME	ON, OFF*	Switch the metronome function ON/OFF.
	METRONOME MONITOR	Master + Headphones*, Headphones	Set the output destination of metronome sound.
	METRONOME VOLUME	0 to 100* to 127	Set the metronome volume.
	COUNT IN	OFF*, 1 BAR, 2 BAR	Set the number of bars for the count in.
	ON AIR DISPLAY	ON*, OFF	Switch the on air display function ON/OFF.
	LCD BRIGHTNESS	1 (dark), 2, 3*, 4, 5 (bright)	Set the brightness of the touch display.
	PAD/BUTTON BRIGHTNESS	DIMMED 3, DIMMED 2, DIMMED 1, NORMAL*	Set the brightness of the performance pads and 16-step keys.
	SCREEN SAVER	ON*, OFF	When this is set to [ON], the screensaver starts if the unit is stopped, paused, or no operation is performed for at least 5 minutes.
	OUTPUT (AUDIO 2)	INPUT THRU*, MASTER	Set the sound to output from the THRU/OUTPUT2 terminals.
	PLAYER No.	AUTO*, PLAYER1, PLAYER2, ..., PARAMETER 4	Set this unit's player number.
	AUTO STANDBY	ON*, OFF	↻ Auto standby function (p.50)
	TOUCH PANEL CALIBRATION	-	↻ Adjusting the touch panel (TOUCH PANEL CALIBRATION) (p.51)
CHARACTER PRIORITY	Default*, Chinese(simplified characters), Chinese(traditional characters), Korean	Set the display language to which to give priority on this unit.	
DEFAULT	-	Return the setting values to the initial values.	
INFORMATIONS	Version No.	-	Displays this unit's software version.
	LICENSE	-	Display information related to the license of the unit.

- \*: Setting upon purchase

## Setting the USER mode of the touch strip (TOUCH STRIP SETTING)

The parameters that operate with **USER1** and **USER2** of the touch strip can be assigned.

### Initial state

Turn the rotary selector to move the focus and select a target of assignment.

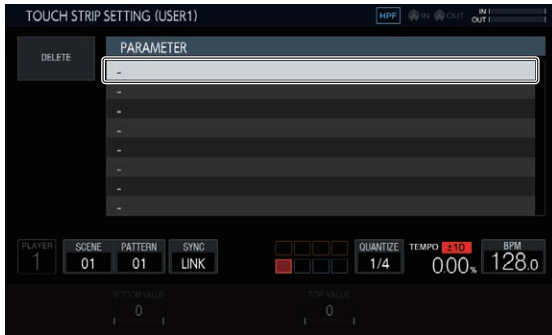

### Assigning

If the rotary selector is pressed, a parameter selection pop-up window appears.

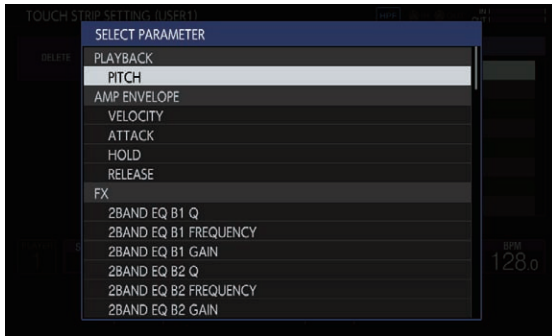

If the parameter to be assigned is selected with the rotary selector and then the rotary selector is pressed, the parameter is assigned. The assigned parameter is displayed.

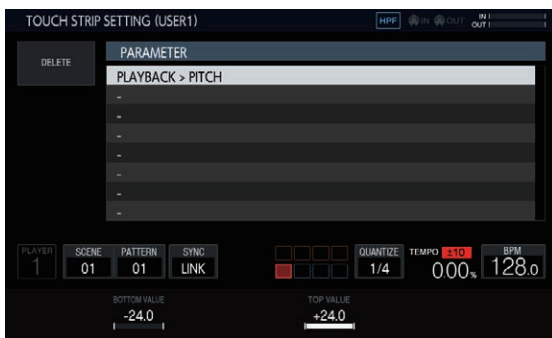

When this procedure is repeated in the same way to assign multiple parameters, the parameter names are added to the list. When the touch strip is touched, the parameters change in accordance with the custom set values.

- Up to eight parameters can be assigned.

## Customizing

The [**BOTTOM VALUE**] value for the bottom and the [**TOP VALUE**] value for the top of the touch strip can be set using the parameter adjustment knobs.

The setting value for each assigned parameter can be set, and the focused value is displayed.



### Deleting

If [**DELETE**] is tapped while the focus is on a parameter to be deleted, the confirmation dialog box appears.

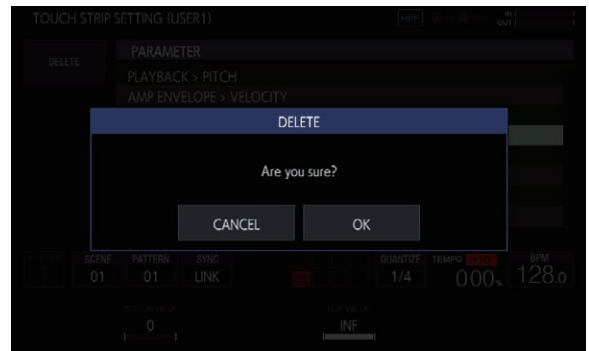

If [**OK**] is tapped, the assignment is deleted.

### Parameter

The parameters that can be assigned are as follows.

Category name	Parameter name
PLAYBACK	PITCH
	VELOCITY
AMP ENVELOPE	ATTACK
	HOLD
	RELEASE

Category name	Parameter name
FX1	2 BAND EQ B1 Q
	2 BAND EQ B1 FREQUENCY
	2 BAND EQ B1 GAIN
	2 BAND EQ B2 Q
	2 BAND EQ B2 FREQUENCY
	2 BAND EQ B2 GAIN
	CHORUS RATE
	CHORUS WIDTH
	CHORUS PHASE
	CHORUS DELAY
	CHORUS MIX RATIO
	COMPRESSOR RATIO
	COMPRESSOR ATTACK
	COMPRESSOR RELEASE
	COMPRESSOR THRESHOLD
	COMPRESSOR GAIN
	COMPRESSOR MIX RATIO
	DELAY TIME
	DELAY FEEDBACK
	DELAY HI CUT
	DELAY MIX RATIO
	DISTORTION DRIVE
	DISTORTION LO FREQ
	DISTORTION HI FREQ
	DISTORTION DYNAMICS
	DISTORTION TONE
	DISTORTION MIX RATIO
	DUCKER ATTACK
	DUCKER ATTACK CURVE
	DUCKER RELEASE
	DUCKER RELEASE CURVE
	DUCKER DEPTH
	FLANGER RATE
	FLANGER WIDTH
	FLANGER PHASE
	FLANGER DELAY
	FLANGER FEEDBACK
	FLANGER MIX RATIO
	LO-FI PREAMP
	LO-FI REDUCTION
	LO-FI BIT DEPTH
	LO-FI CUTOFF
	LO-FI RESONANCE
LO-FI MIX RATIO	
MULTI MODE FILTER CUTOFF	
MULTI MODE FILTER GAIN	
MULTI MODE FILTER RESONANCE	
MULTI MODE FILTER GLIDE	
MULTI MODE FILTER MIX RATIO	
PHASER RATE	
PHASER WIDTH	
PHASER PHASE	
PHASER FREQUENCY	
PHASER FEEDBACK	
PHASER MIX RATIO	
MIDI NOTE	VELOCITY
	LENGTH

Category name	Parameter name
MIDI CC1	PARAMETER 1 PITCH BEND
	PARAMETER 2 AFTER TOUCH
	PARAMETER 3
	PARAMETER 4
	PARAMETER 5
	PARAMETER 6
MIDI CC2	PARAMETER 1
	PARAMETER 2
	PARAMETER 3
	PARAMETER 4
	PARAMETER 5
	PARAMETER 6
MIXER	VOLUME
	PAN
LFO	SPEED
	DEPTH
SEQUENCE	RETRIGGER CNT
	RETRIGGER SPD

- Even if a target parameter is selected, the LFO effect will not be applied if an effect, MIDI track, etc. including that parameter is not assigned.

## Auto standby function

When the auto standby function is turned on, the power is automatically set to standby mode after four hours have passed with all of the following conditions met.

- None of this unit's buttons or controls are operated.
- The track level indicators are not lit.
- The playback function is not operating.
- No PRO DJ LINK connections are made.
- A USB device is not connected to the USB device insertion slot (Type A terminal) on the top panel of the unit.
- The indicator of the **[HOME/UTILITY/WAKE UP]** button is lit during auto standby.
- When the **[HOME/UTILITY/WAKE UP]** button is pressed, the standby status is canceled.
- This unit is shipped with the auto standby function turned on. If you do not want to use the auto standby function, set **[AUTO STANDBY]** to **[OFF]**.

## Adjusting the touch panel (TOUCH PANEL CALIBRATION)

This function is for making adjustments when the touch panel of this unit is not working properly.  
Display the TOUCH PANEL CALIBRATION screen from the UTILITY screen.

Tap the cross marks on the screen in the order of bottom right → top right → top left → bottom left.  
When adjustment is finished, the TOUCH PANEL CALIBRATION screen closes.

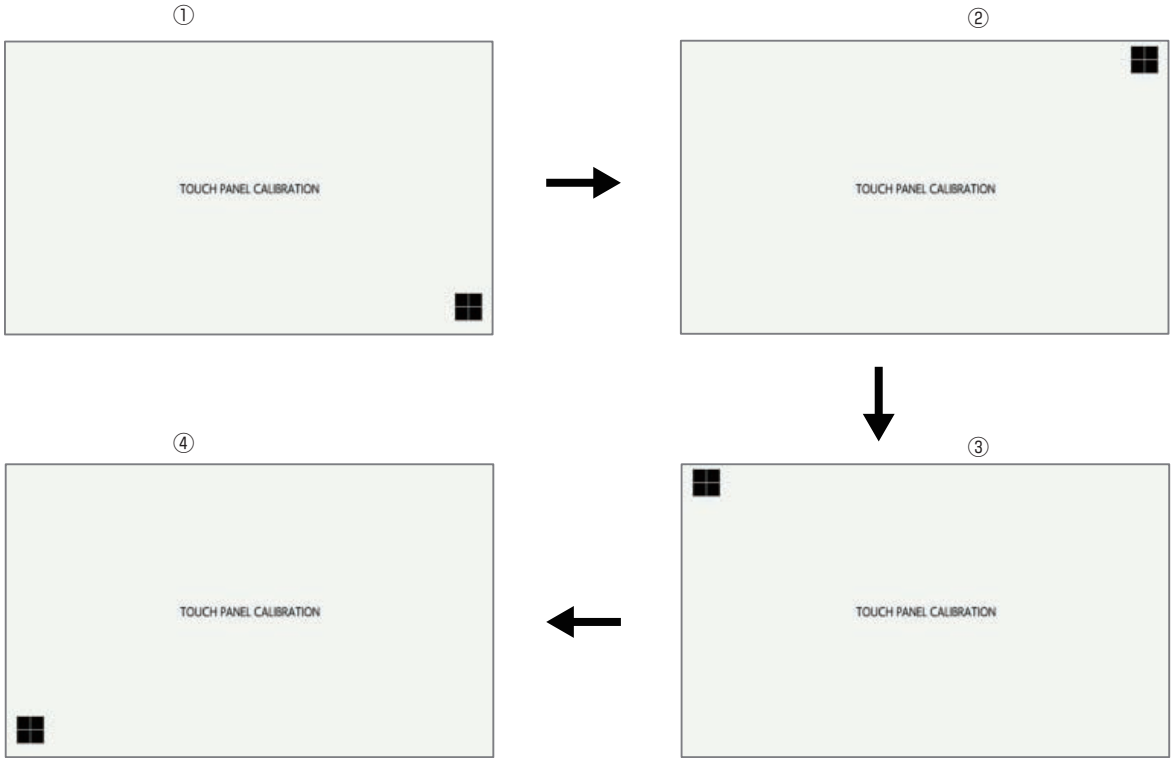

# MIDI implementation chart

The following describes the correspondence between the functions and MIDI messages when the unit receives MIDI messages to perform operations from an external MIDI device.

## Connections

### Connecting with DIN MIDI

- 1 Connect the MIDI OUT terminal of the external MIDI device and the MIDI IN terminal of this unit with a MIDI cable.
- 2 Tap [SYNC] in the HOME screen, etc. to display the SYNC screen.
- 3 Tap [DIN MIDI] or [DIN MIDI(THRU H/W)] in MIDI I/F SELECT.

### Connecting with USB MIDI

- 1 Connect your computer and the USB-B terminal of this unit with a USB cable.
- 2 Tap [SYNC] in the HOME screen, etc. to display the SYNC screen.
- 3 Tap [USB MIDI] in MIDI I/F SELECT.

## Setting whether or not to receive various MIDI messages

Configure the settings for whether or not to receive various MIDI messages in the **PROJECT SETTING (MIDI IN)** category of the UTILITY screen. The setting items and setting values are as follows.

Option settings	Options
CLOCK	ENABLE/DISABLE

- **ENABLE:** Synchronizes the BPM of the sequence of the unit to **MIDI CLOCK** from the external MIDI device.
- **DISABLE:** Does not receive **MIDI CLOCK** from the external MIDI device.

Option settings	Options
START/STOP/CONTINUE	ENABLE/DISABLE

- **ENABLE:** Synchronizes to sequence play/stop and other operations of the external MIDI device.
- **DISABLE:** Does not receive the **START**, **STOP**, and **CONTINUE** messages from the external MIDI device.

Option settings	Options
NOTE/CC	ENABLE/DISABLE

- **ENABLE:** Enables operation of the device in accordance with **NOTE** and **CC** (including **Pitch Bend**) from the external MIDI device.
  - **DISABLE:** Does not receive the **NOTE** and **CC** (including **Pitch Bend**) messages from the external MIDI device.
- ✓ In addition to the setting values, NOTE is received only when TRACK TYPE is **SAMPLE**.
- ✓ In addition to the setting values, CC is received only when TRACK TYPE is **SAMPLE** or **THRU**.

Option settings	Options
SONG POSITION	ENABLE/DISABLE

- **ENABLE:** Determines the playback position from the song position pointer from the external MIDI device.
- **DISABLE:** Does not receive the song position pointer from the external MIDI device.

## Setting the MIDI IN channel

Configure the MIDI IN channel setting in the **PROJECT SETTING (MIDI IN)** category of the UTILITY screen. The setting items and setting values are as follows.

Option settings	Options
CHANNEL MAPPING	None (The CH setting pop-up screen appears.)

Any MIDI CH (CH.1 to CH.16) can be set for each track (TRACK1 to TRACK16). Set OFF for any track for which you do not wish to receive MIDI messages.

- The same MIDI CH cannot be set for multiple tracks. One MIDI CH can be set for only one track.

Option settings	Options
CHANNEL MAPPING RESET	None (Executes <b>RESET</b> .)

The MIDI CH set in **[CHANNEL MAPPING]** is reset. When a reset is performed, the track number and MIDI CH are restored to the initial values of the same number.

- TRACK1 to TRACK16: CH.1 to CH.16

## Notes

Trigger the sample of each track. A sample is triggered no matter which MIDI channel.

Function	NOTE number
TRACK1 trigger	0
TRACK2 trigger	1
TRACK3 trigger	2
TRACK4 trigger	3
TRACK5 trigger	4
TRACK6 trigger	5
TRACK7 trigger	6
TRACK8 trigger	7
TRACK9 trigger	8
TRACK10 trigger	9
TRACK11 trigger	10
TRACK12 trigger	11
TRACK13 trigger	12
TRACK14 trigger	13
TRACK15 trigger	14
TRACK16 trigger	15

The track corresponding to the MIDI channel set in **[CHANNEL MAPPING]** of UTILITY is triggered along with PITCH. When the TIME STRETCH setting of the track is **[M.TMP]**, PITCH is restricted to the range of  $\pm 12$ .

### TIME STRETCH: OFF, RESMPL

Function	NOTE number
Sample trigger (PITCH: -24)	24
Sample trigger (PITCH: -23)	25
Sample trigger (PITCH: -22)	26
Sample trigger (PITCH: -21)	27
Sample trigger (PITCH: -20)	28

Function	NOTE number
Sample trigger (PITCH: -19)	29
Sample trigger (PITCH: -18)	30
Sample trigger (PITCH: -17)	31
Sample trigger (PITCH: -16)	32
Sample trigger (PITCH: -15)	33
Sample trigger (PITCH: -14)	34
Sample trigger (PITCH: -13)	35
Sample trigger (PITCH: -12)	36
Sample trigger (PITCH: -11)	37
Sample trigger (PITCH: -10)	38
Sample trigger (PITCH: -9)	39
Sample trigger (PITCH: -8)	40
Sample trigger (PITCH: -7)	41
Sample trigger (PITCH: -6)	42
Sample trigger (PITCH: -5)	43
Sample trigger (PITCH: -4)	44
Sample trigger (PITCH: -3)	45
Sample trigger (PITCH: -2)	46
Sample trigger (PITCH: -1)	47
Sample trigger (PITCH: ±0)	48
Sample trigger (PITCH: +1)	49
Sample trigger (PITCH: +2)	50
Sample trigger (PITCH: +3)	51
Sample trigger (PITCH: +4)	52
Sample trigger (PITCH: +5)	53
Sample trigger (PITCH: +6)	54
Sample trigger (PITCH: +7)	55
Sample trigger (PITCH: +8)	56
Sample trigger (PITCH: +9)	57
Sample trigger (PITCH: +10)	58
Sample trigger (PITCH: +11)	59
Sample trigger (PITCH: +12)	60
Sample trigger (PITCH: +13)	61
Sample trigger (PITCH: +14)	62
Sample trigger (PITCH: +15)	63
Sample trigger (PITCH: +16)	64
Sample trigger (PITCH: +17)	65
Sample trigger (PITCH: +18)	66
Sample trigger (PITCH: +19)	67
Sample trigger (PITCH: +20)	68
Sample trigger (PITCH: +21)	69
Sample trigger (PITCH: +22)	70
Sample trigger (PITCH: +23)	71
Sample trigger (PITCH: +24)	72

#### TIME STRETCH:M.TMP

Function	NOTE number
Sample trigger (PITCH: -12)	24 to 36
Sample trigger (PITCH: -11)	37
Sample trigger (PITCH: -10)	38
Sample trigger (PITCH: -9)	39
Sample trigger (PITCH: -8)	40
Sample trigger (PITCH: -7)	41
Sample trigger (PITCH: -6)	42
Sample trigger (PITCH: -5)	43
Sample trigger (PITCH: -4)	44
Sample trigger (PITCH: -3)	45
Sample trigger (PITCH: -2)	46
Sample trigger (PITCH: -1)	47
Sample trigger (PITCH: ±0)	48
Sample trigger (PITCH: +1)	49

Function	NOTE number
Sample trigger (PITCH: +2)	50
Sample trigger (PITCH: +3)	51
Sample trigger (PITCH: +4)	52
Sample trigger (PITCH: +5)	53
Sample trigger (PITCH: +6)	54
Sample trigger (PITCH: +7)	55
Sample trigger (PITCH: +8)	56
Sample trigger (PITCH: +9)	57
Sample trigger (PITCH: +10)	58
Sample trigger (PITCH: +11)	59
Sample trigger (PITCH: +12)	60 to 72

## Control changes

Receive MIDI control changes from an external MIDI device to operate various functions of the unit.

Option settings	CC number	
TRACK	VOLUME	7
	PAN	10
	TIME STRETCH	14
	LOOP	15
	TRIGGER MODE	16
	SEND AMOUNT	17
PLAYBACK	MUTE	18
	PITCH	20
	START	21
	LOOP START	22
AMP ENVELOPE	LENGTH	23
	VELOCITY	26
	ATTACK	27
	HOLD	28
FX1	RELEASE	29
	Param1	46
	Param2	47
	Param3	48
	Param4	49
	Param5	50
SEQUENCE	Param6	51
	OFFSET	54
	RETRIGGER CNT	55
LFO	RETRIGGER SPD	56
	SPEED	60
	DEPTH	61
	PHASE OFFSET	62

Switch the scene or pattern. A pattern is received and entered for scene switching just like when performing the operation on the unit. Switching of the scene and pattern is disabled when the SAMPLING/EDIT screen is displayed. Other MIDI messages that are received during scene and pattern switching are ignored.

Function	CC number	Notes
SCENE selection	0	CC values 16 and higher are handled as SCENE16.
PATTERN selection	32	CC values 16 and higher are handled as PATTERN16.

---

---

## Pitch bend

Pitch bending is performed for the sample of the track corresponding to the MIDI channel set in **[CHANNEL MAPPING]** of UTILITY. This is enabled only when the mode of the touch strip is **[PITCH]**.

---

---

## Mode message

This message is received with the track corresponding to the MIDI channel set in **[CHANNEL MAPPING]** of UTILITY. **[ALL NOTE OFF]** is supported, and the sound currently being produced stops with the mode message.



# Additional information

## Troubleshooting

- Improper operation is often mistaken for trouble or a malfunction that occurred in the device. If something is wrong with this unit, check the following issues, and also access the following Pioneer DJ support site and check [FAQ] for [DJS-1000].  
pioneerdj.com  
Some problems occur due to the connected components. If the problem cannot be resolved after checking the connected components, ask the service center or your dealer for repairs.
- The unit may not operate properly due to static electricity or other external influences. In such cases, disconnect the power cord and connect it again to restore normal operation.

Problem	Check	Remedy
The unit does not turn on. The indicators do not light up.	Is the power cord properly connected?	Connect the power cord to an AC outlet. (page 4)
	Is the [ⓘ] switch of the power on the rear panel of the unit on?	Properly connect the included power cord to a power outlet. Turn on the [ⓘ] switch.
Sound is not output, or sound is too small.	Are the various parameter volumes on the touch display set to the correct positions or values?	Adjust the various parameter volumes on the touch display to the appropriate positions or values.
	In the case of an external sound source input, is the [INPUT LEVEL] control on the top panel of the unit set to the correct position? Is the output level of the external sound source input device too low?	Adjust the [INPUT LEVEL] control on the top panel of the unit or the output level of the external sound source input device while referring to INPUT MONITOR.
Sound is distorted.	Are the various parameter volumes on the touch display set to the correct positions or values?	Adjust the various parameter volumes in the graphical user interface to appropriate levels so that the peak level of the master level meter lights near 0 dB.
	Is the [INPUT LEVEL] control set to the proper position? Is the output level of the external sound source input device too high?	Adjust the [INPUT LEVEL] control on the rear panel of the unit or the output level of the external sound source input device while referring to INPUT MONITOR.
USB device is not recognized.	Is the USB device properly connected?	Connect the USB device securely (all the way in).
	Is the USB device connected via a USB hub?	Do not use a USB hub.
	Is the USB device supported by this unit?	This unit supports such USB mass storage class USB devices as external hard disks and portable flash memory devices.
	Is the file format supported by this unit? —	Check that the file format of the connected USB device is supported by the unit. Turn the unit off, wait for 1 minute, and then turn the unit on.
It takes time to read USB devices (flash memory drives and hard discs).	Are many folders and files stored on the USB device?	It takes time to read a connected USB device if the device contains many folders and files.
	Are files other than music files stored on the USB device?	It takes time to read a connected USB device if files other than music files are stored in folders. Do not store files or folders other than music files on the USB device.
Files cannot be played.	Is the file copyright-protected (by DRM)?	Copyright-protected files cannot be played.
Music files cannot be played.	Are the music files damaged?	Play music files that are not damaged.
The unit does not respond when the screen is touch, or the response is poor. The detected position is different from the position actually touched.	Deviation in touch display calibration.	Adjust touch screen detection with the [TOUCH PANEL CALIBRATION] settings on the [UTILITY] screen.
Nothing is displayed.	Is the auto standby function activated?	This unit is shipped with the auto standby function set to on. If you do not want to use the auto standby function, set [AUTO STANDBY] on the [UTILITY] menu to [OFF]. (page 50)

## Liquid crystal display

- Small black or shining points may appear on the liquid crystal display. This is a phenomenon inherent to liquid crystal displays; this is not a malfunction.
- When using in cold places, the liquid crystal display may be dark for a while after this unit's power is turned on. It will reach the normal brightness after a while.
- When the liquid crystal display is exposed to direct sunlight, the light will reflect off it, making it difficult to see. Block the direct sunlight.

## Cleaning the touch display

Do not use organic solvents, acids or alkalis for cleaning the surface of the touch display. Wipe clean with a dry soft cloth or a cloth immersed in neutral detergent and properly wrung.

# Signal flow

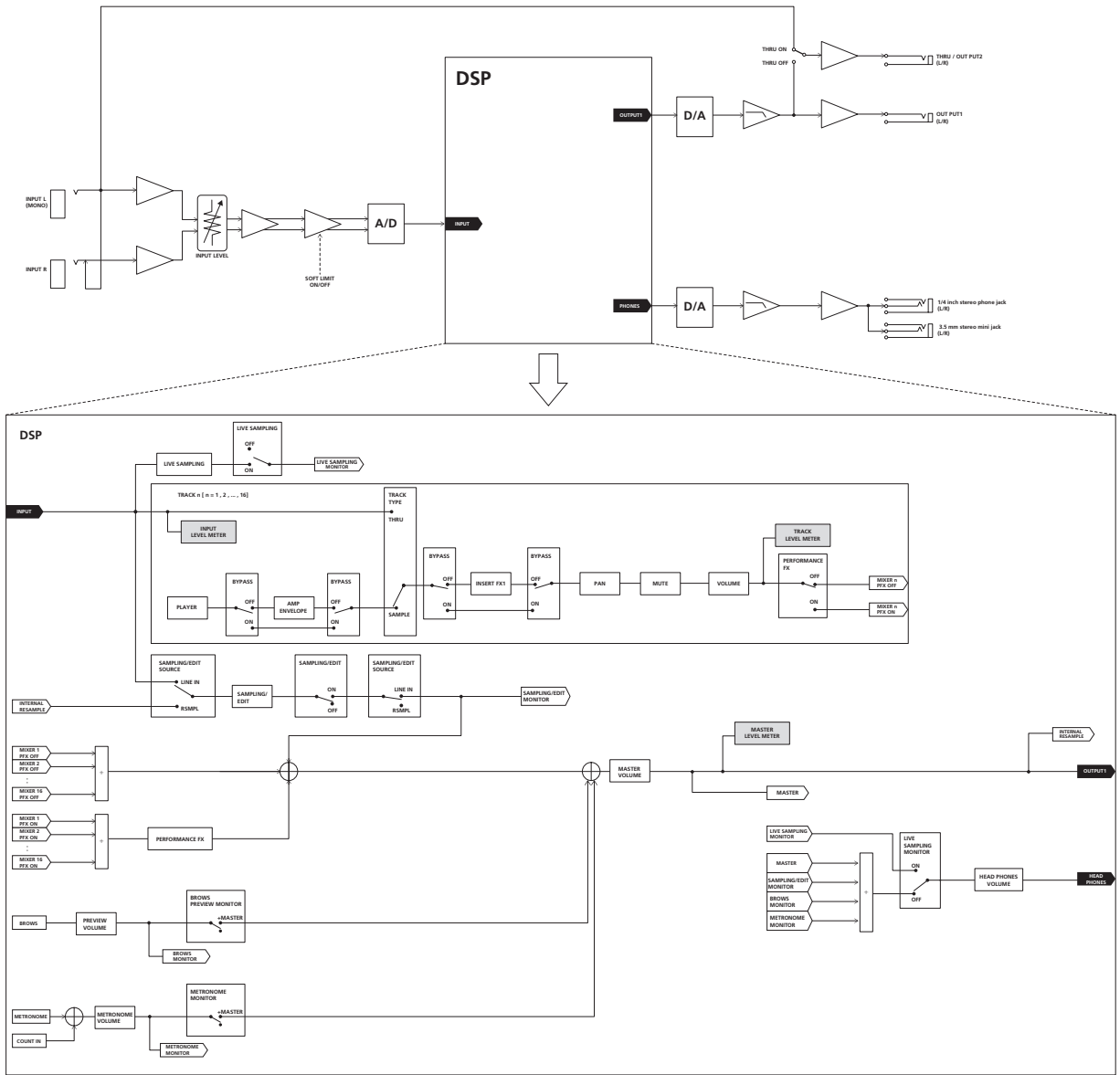

This unit is manufactured for general household purposes. Note that charges will apply for repairs even during the warranty period in the event of failures that occur during use in situations other than for household purposes (such as long-term use for business purposes in a restaurant or other establishment or use in a car or ship).

## Trademarks and registered trademarks

- "Pioneer DJ" is a trademark of PIONEER CORPORATION, and is used under license.
- This software is based in part on the work of the Independent JPEG Group.
- Loopmasters is a registered trademark of Loopmasters Ltd.

## Cautions on copyrights

When playing music files you have acquired on this unit, we kindly ask you to respect copyrights. Recordings you have made are for your personal enjoyment and according to copyright laws may not be used without the consent of the copyright holder.

- When handling music downloaded from the Internet, etc., it is the full responsibility of the person who has downloaded the music to ensure that it is used in accordance with the contract concluded with the download site.
- The specifications and design of this product are subject to change without notice.

© 2017 Pioneer DJ Corporation. All rights reserved.  
<DR11489-A>