

Instruction Manual

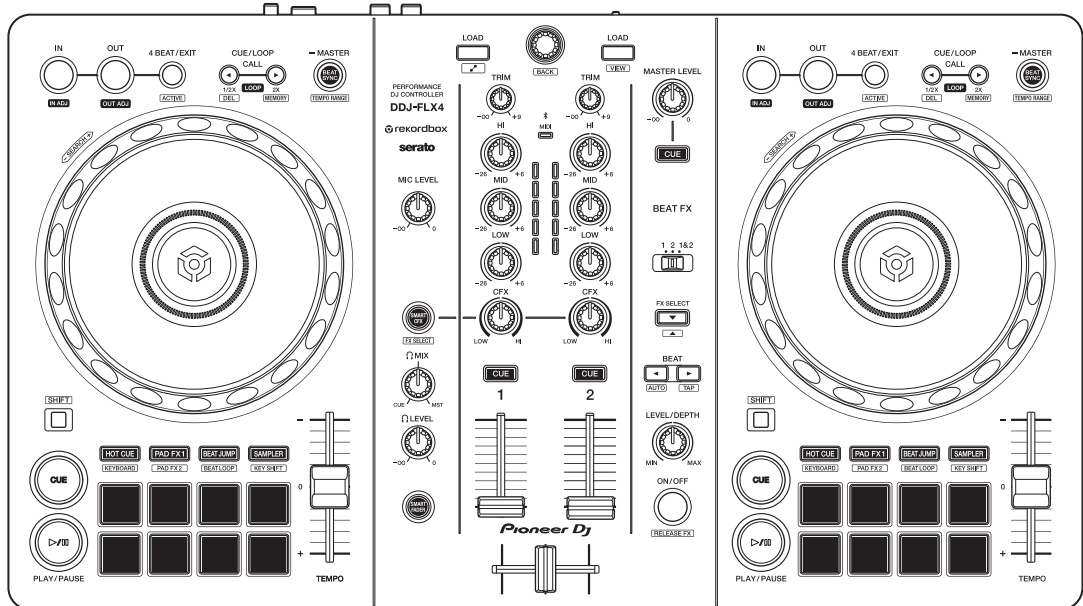

DJ Controller

DDJ-FLX4

pioneerdj.com/support/

rekordbox.com

serato.com

For FAQ and other support information for this product, visit the websites above.

Pioneer Dj

serato

Bluetooth®

How to read this manual

Thank you for choosing this Pioneer DJ product.

Be sure to read this manual, the “Quick Start Guide” and the “Precautions for Use” which are included with this product. These documents include important information that you should understand before using the unit. In particular, be sure to read the **IMPORTANT SAFETY INSTRUCTIONS**.

- In this manual, the names of buttons, knobs, and terminals that appear on the product, and the names of buttons, menus, etc. in the software on your PC/Mac or mobile device, are indicated within square brackets ([]). (e.g. **[File]**, **[CUE]** button)
- Please note that the software screens and their specifications, as well as the external appearance and specifications of the hardware, are subject to change without notice.
- Please note that depending on the operating system version, web browser settings, etc. operation may differ from the ways described in this manual.
- Please note that the language on the screens of the software described in this manual may differ from the language on your screen.

What's in the box

- USB cable
 - Warranty (for some regions)*
 - Quick Start Guide
 - Precautions for Use
- * Only products in North America and Europe.

Contents

How to read this manual	2
What's in the box	3
Before you start.....	6
User guides.....	6
DJ software.....	7
Part names and functions	10
Top panel.....	11
Browse section	12
Deck section	15
Mixer section.....	25
Effects section	31
Rear panel	34
Front panel.....	36
Connections.....	37
Connection examples	39
rekordbox for Mac/Windows	45
Installing rekordbox for Mac/Windows	45
Basic use	48
Advanced use	54
Changing the settings in rekordbox for Mac/Windows.....	77
Serato DJ Lite	81
Installing Serato DJ Lite.....	81
Basic use	84
Advanced use	91

rekordbox for iOS/Android	107
Installing rekordbox for iOS/Android	107
Basic use	109
Advanced use	120
Changing the settings in rekordbox for iOS/Android.....	140
Changing the settings.....	144
Launching Utilities mode.....	144
Utilities mode settings.....	145
Changing the Bluetooth® MIDI device name	148
Additional information	150
Troubleshooting	150
Specifications.....	159
Using the unit as a controller for other DJ applications	161
Trademarks and registered trademarks.....	162
Software license notice.....	163
Cautions on copyrights	165

Before you start

User guides

rekordbox Introduction, Instruction Manual

Refer to the “rekordbox Introduction” to find out how to set up rekordbox for Mac/Windows, and see the “rekordbox Instruction Manual” to find out how to use rekordbox for Mac/Windows.

rekordbox.com/manual

Serato DJ Lite software manual

Visit the Serato DJ Lite website.

serato.com/dj/lite/downloads

DJ software

rekordbox for Mac/Windows

- rekordbox for Mac/Windows is a complete DJ application you can use to manage your music and perform.
- Even if you don't have a paid subscription plan, you can use Performance mode by connecting this unit to your PC/Mac with rekordbox for Mac/Windows installed. This is called Hardware Unlock.
- You'll find details of the functions available via Hardware Unlock on **[Hardware Unlock]** under **[Support]** at rekordbox.com
- The rekordbox for Mac/Windows software is not included with the unit. Download the software from the URL below.
rekordbox.com
- For information on the latest system requirements, compatibility, and supported operating systems of rekordbox for Mac/Windows, check **[System requirements]** under **[Support]** at rekordbox.com.
- Operation isn't guaranteed on all PC/Mac models, even if the system requirements are met.
- Depending on power-saving settings and other conditions of the PC/Mac, the CPU and hard disk may not provide sufficient processing capabilities. For laptops in particular, make sure the PC/Mac is in the best condition to provide constant high-level performance when using rekordbox for Mac/Windows (for example by keeping the AC power connected).
- To use the internet, you need a separate contract with an internet service provider, which you may have to pay for.
- Operating system support always assumes you're using the latest point release for that version.

Serato DJ Lite

Serato DJ Lite is DJ software from Serato Limited.

This unit unlocks the software, which you can download from the Serato website.

serato.com/dj/lite/downloads

- If you haven't registered an account, follow the steps below.
 - Follow the instructions on the screen to enter your email address and create a password, then click the **[Create account]** icon. Follow the instructions on the screen to download the Serato DJ Lite software.
 - Once you've registered an account, you'll receive an email. Check the contents of the email.
- Be careful not to forget the email address and password you used to register. You'll need them to update the software in future.
- The personal information you entered when registering your user account may be collected, processed, and used based on the privacy policy published on the Serato website.
- For information on the latest system requirements, compatibility, and supported operating systems of Serato DJ Lite, visit the website below.

serato.com/dj/lite/downloads

- Operation isn't guaranteed on all PC/Mac models, even if the system requirements are met.
- Depending on power-saving settings and other conditions of the PC/Mac, the CPU and hard disk may not provide sufficient processing capabilities. For laptops in particular, make sure the PC/Mac is in the best condition to provide constant high-level performance when using Serato DJ Lite (for example by keeping the AC power connected).

rekordbox for iOS/Android

- rekordbox for iOS/Android is a mobile device application you can use to manage your music and perform.
- By connecting a mobile device running rekordbox for iOS/Android to the unit via a USB cable or Bluetooth, you can perform with music files stored on the device or from a compatible streaming service.
- Install the latest version of rekordbox for iOS/Android from the App Store or Google Play (page 107).
- rekordbox for iOS can be used on iOS and iPad OS devices. rekordbox for Android can be used on Android devices. For information on the latest supported operating systems and devices, check **[Mobile]** under **[FEATURES]** at rekordbox.com.
- Operation isn't guaranteed on all mobile devices listed on the above website.
- To power the unit, use a USB power adapter or mobile battery.

Part names and functions

This unit supports the following DJ software.

- rekordbox for Mac/Windows
- rekordbox for iOS/Android
- Serato DJ Lite
- Serato DJ Pro (paid license needed.)

The following section shows functions of rekordbox for Mac/Windows, rekordbox for iOS/Android, and Serato DJ Lite separately.

About “❖ Using rekordbox for Mac/Windows or rekordbox for iOS/Android”

Functions available only in rekordbox for Mac/Windows are shown with **Mac/Windows**.

Functions available only in rekordbox for iOS/Android are shown with **iOS/Android**.

Functions available for Mac/Windows/iOS/Android are shown without the above symbols.

About “❖ Using Serato DJ Lite”

This section mainly relates to Serato DJ Lite.

Functions available only in Serato DJ Pro are shown with **Serato DJ Pro**.

Top panel

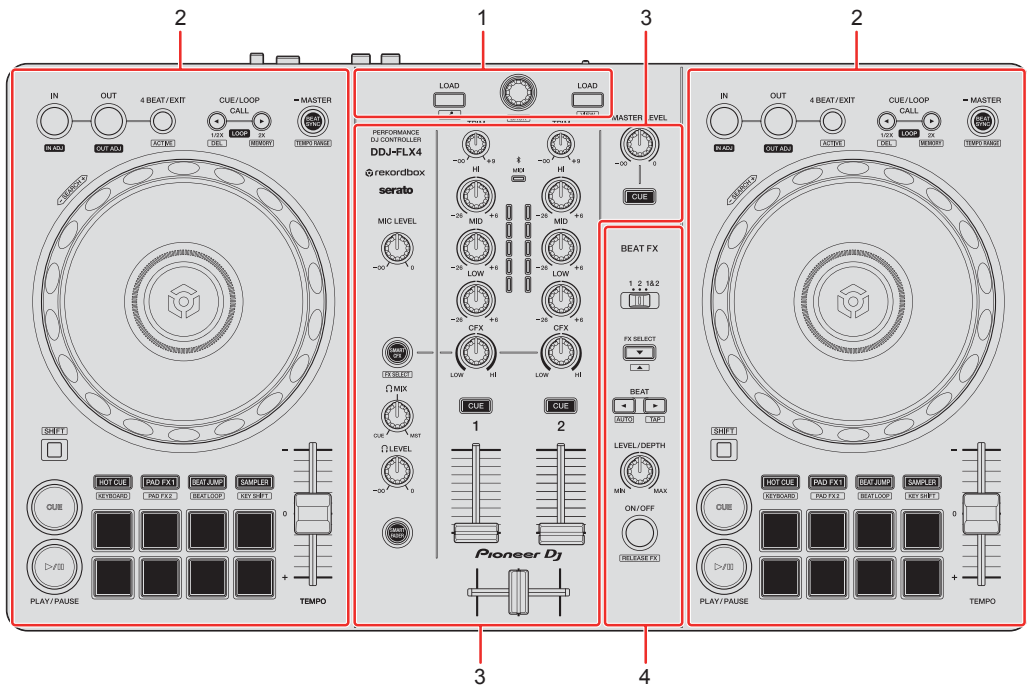

1 Browse section

Selects tracks and loads them to the decks.

2 Deck sections

Control each deck. There are knobs and buttons on the left side to control deck 1, and on the right side to control deck 2.

3 Mixer section

Controls the level adjustment for each channel, track mixing, etc.

4 Effects section

Controls the effect units.

Browse section

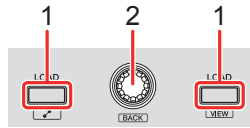

❖ Using rekordbox for Mac/Windows or rekordbox for iOS/Android

1 LOAD buttons

Press:

Load the selected track to the respective deck.

Mac/Windows

Press twice:

Load the track from the deck that isn't playing onto the deck that is playing. If you do this while the track is playing, it plays from the same position (Instant Doubles).

[SHIFT] + press:

Mac/Windows

Deck 1: Moves the cursor into **[Related Tracks]** in the tree view.

Deck 2: Shrinks the deck display in rekordbox and enlarges the browse section. When the button is pressed again, the original state is restored.

iOS/Android

Deck 1: Displays the browse window and shows **[Related Tracks]**.

Deck 2: Displays the browse window.

2 Rotary selector

Turn:

Moves the cursor in rekordbox.

Mac/Windows

[SHIFT] + turn:

Enlarges or shrinks the enlarged waveform in rekordbox.

Turn to the right to enlarge, or the left to shrink it.

Press:

Mac/Windows

Moves the cursor between the tree view and track list each time you press the button. If the cursor is pointed to a folder, the folder opens.

- If the playlist palette is displayed, you can also move the cursor to the playlist.
- The tree view, track list, and playlist palette are displayed in the browse section of rekordbox. For details on each, read the “rekordbox Instruction Manual”.

iOS/Android

Moves the cursor to the next level down.

[SHIFT] + press:

Mac/Windows

Moves the cursor between the tree view and track list each time you press the button. If the cursor is pointed to a folder, the folder closes.

iOS/Android

Moves the cursor to the next level up.

❖ Using Serato DJ Lite

1 LOAD buttons

Press:

Load the selected track to the respective deck.

Press twice:

Load the track from the deck that isn't playing onto the deck that is playing. If you do this while the track is playing, it plays from the same position (Instant Doubles).

[SHIFT] + press:

Sorts the track list in the library as follows, depending on the **[LOAD]** button you press:

Deck 1: Sorts by BPM.

Deck 2: Sorts by artist name.

2 Rotary selector

Turn:

Moves the cursor up or down in the library or in the **[crates]** panel.

Press:

Moves the cursor between the library and **[crates]** panel each time you press the button.

If the cursor is on the **[Files]** panel, it moves to the next level down.

[SHIFT] + press:

If the cursor is on the **[crates]** panel, the **[subcrates]** panel opens or closes.

If the cursor is on the library, it moves to the **[crates]** panel.

If the cursor is on the **[Files]** panel, it moves up one level.

Deck section

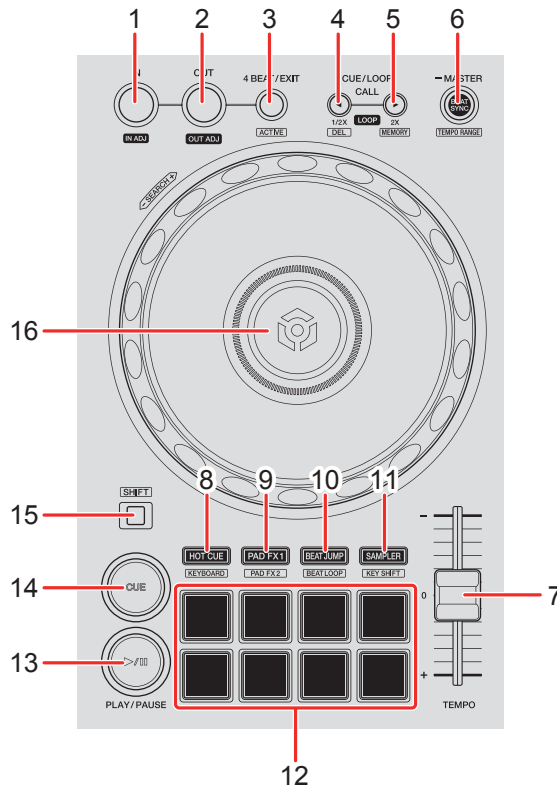

❖ Using rekordbox for Mac/Windows or rekordbox for iOS/Android

1 IN button

Press:

Sets the loop in point.

Press (during loop playback):

Adjusts the loop in point using the jog wheel.

2 OUT button

Press:

Sets the loop out point, and loop playback begins.

Press (during loop playback):

Adjusts loop out point using the jog wheel.

3 4 BEAT/EXIT button

Press:

Starts Auto Beat Loop of 4 beats.

Press (during loop playback):

Cancels loop playback.

[SHIFT] + press:

Sets/cancels the loop nearest the playback position as Active Loop. This is enabled for loops saved on the track or set in Hot Cue mode.

- If Active Loop is set, the loop playback automatically starts when the playback position reaches the loop in point.

4 CUE/LOOP CALL ◀ button

Press:

Selects and calls up the cue point or loop point.

Press (during loop playback):

Halves the loop playback length.

[SHIFT] + press:

Deletes the called-up cue point or loop points.

5 CUE/LOOP CALL ▶ button

Press:

Selects and calls up the cue point or loop point.

Press (during loop playback):

Doubles the loop playback length.

[SHIFT] + press:

During cue standby, saves the cue point.

During loop playback, saves the loop.

6 BEAT SYNC button

Press:

Automatically synchronizes the tempo (BPM) and beatgrid with the deck set as the master.

Press (during Beat Sync):

Cancels Beat Sync.

Press for at least a second:

Sets the relevant deck as the master.

[SHIFT] + press:

Switches the range of the **[TEMPO]** slider each time the button is pressed while holding the **[SHIFT]** button.

Switch between **[±6%]** → **[±10%]** → **[±16%]** → **[WIDE]** → **[±6%]**.

iOS/Android

Hold down the **[BEAT SYNC]** buttons on deck 1 and deck 2 for at least one second at the same time:

The Bluetooth connection of the iOS/Android device is canceled.

7 TEMPO slider

Adjusts the playing speed of the track.

8 HOT CUE mode button

Press:

Enters Hot Cue mode.

👉 Read more: Using Hot Cues (page 56)

[SHIFT] + press:

Enters Keyboard mode.

➡ Read more: Using Keyboard mode (page 62)

9 PAD FX1 mode button

Press:

Enters Pad FX mode 1.

➡ Read more: Using Pad FX (page 58)

[SHIFT] + press:

Enters Pad FX mode 2.

➡ Read more: Using Pad FX (page 58)

10 BEAT JUMP mode button

Press:

Enters Beat Jump mode.

➡ Read more: Using Beat Jump (page 59)

[SHIFT] + press:

Enters Beat Loop mode.

➡ Read more: Using Beat Loop (page 64)

11 SAMPLER mode button

Press:

Enters Sampler mode.

➡ Read more: Using Sampler (page 60)

[SHIFT] + press:

Enters Key Shift mode.

➡ Read more: Using Key Shift (page 65)

12 Performance Pads

Press:

You can use Performance Pads to trigger various features.

➡ Read more: Using the Performance Pads (page 56)

13 PLAY/PAUSE ►/|| button

Press:

Plays/pauses a track.

14 CUE button

Press:

Sets, calls up, and plays a cue point.

- Press the button when the track is paused to set the cue point.
- Press the button when the track is playing to return to the cue point and pause. (Back Cue)
- Press the button and hold it after the track returns to the cue point and playback will continue until you release the button. (Cue Point Sampler)

[SHIFT] + press:

Returns the playback position to the beginning of the track.

15 SHIFT button

Press another button while holding the [SHIFT] button to use a different feature assigned to the button.

16 Jog wheel

Mac/Windows

Turn the top when Vinyl mode is on:

Scratches the track.

iOS/Android

Turn the top:

Scratches the track.

Mac/Windows

Turn the outer section or turn the top when Vinyl mode is off:

Bends the pitch (Pitch Bend – slows down or speeds up the track).

- You can turn Vinyl mode on and off using shortcut keys in rekordbox.

iOS/Android

Turn the outer section:

Bends the pitch (Pitch Bend – slows down or speeds up the track).

[SHIFT] + turn the top:

Fast-forward or fast-reverse the track with extra speed.

❖ Using Serato DJ Lite

1 IN button

Press:

Sets the loop in point.

Press (during loop playback):

Adjusts the loop in point using the jog wheel.

2 OUT button

Press:

Sets the loop out point, and loop playback begins.

Press (during loop playback):

Adjusts loop out point using the jog wheel.

[SHIFT] + press:

Turns Vinyl mode on/off.

3 4 BEAT/EXIT button

Press:

Starts Auto Beat Loop of 4 beats.

Press (during loop playback):

Cancels loop playback.

[SHIFT] + press:

Switches the active/non-active status of the loop.

4 CUE/LOOP CALL ◀ button

Press (during loop playback):

Halves the loop playback length.

Serato DJ Pro

Press:

Selects the loop slot.

5 CUE/LOOP CALL ▶ button

Press (during loop playback):

Doubles the loop playback length.

Serato DJ Pro

Press:

Selects the loop slot.

6 BEAT SYNC button

Press:

The tempo (BPM) and beatgrid of multiple decks are automatically synchronized.

[SHIFT] + press:

Switches the range of the **[TEMPO]** slider each time the button is pressed while holding the **[SHIFT]** button.

Switch between **[±8%]** → **[±16%]** → **[±50%]** → **[±8%]**.

Press for at least a second:

Cancels Beat Sync.

7 TEMPO slider

Adjusts the playing speed of the track.

8 HOT CUE mode button

Press:

Enters Hot Cue mode.

➡ Read more: Using Hot Cues (page 92)

Serato DJ Pro

[SHIFT] + press:

Enters Pitch Play mode.

➡ Read more: Using Pitch Play (page 96)

9 PAD FX1 mode button

Press:

Enters Pad FX mode.

➡ Read more: Using Pad FX (page 93)

Serato DJ Pro

[SHIFT] + press:

Enters Roll mode.

➡ Read more: Using Roll (page 97)

10 BEAT JUMP mode button

Press:

Enters Beat Jump mode.

➡ Read more: Using Beat Jump (page 94)

[SHIFT] + press:

Enters Auto Loop mode.

➡ Read more: Using Auto Loop (page 98)

11 SAMPLER mode button

Press:

Enters Sampler mode.

➡ Read more: Using Sampler (page 95)

Serato DJ Pro

[SHIFT] + press:

Enters Key Shift mode.

➡ Read more: Using Key Shift (page 99)

12 Performance Pads

Press:

You can use Performance Pads to trigger various features.

➡ Read more: Using the Performance Pads (page 92)

13 PLAY/PAUSE ►/⏸ button

Press:

Plays/pauses a track.

[SHIFT] + press:

Returns to the temporary cue point and playback starts (Stutter).

14 CUE button

Press:

Sets, calls up, and plays a cue point.

- Press the button when the track is paused to set the cue point.
- Press the button when the track is playing to return to the cue point and pause. (Back Cue)
- Press the button and hold it after the track returns to the cue point and playback will continue until you release the button. (Cue Point Sampler)

[SHIFT] + press:

Returns the playback position to the beginning of the track.

15 SHIFT button

Press another button while holding the **[SHIFT]** button to use a different feature assigned to the button.

16 Jog wheel

Turn the top when Vinyl mode is on:
Scratches the track.

Turn the outer section or turn the top when Vinyl mode is off:
Bends the pitch (Pitch Bend – slows down or speeds up the track).

[SHIFT] + turn the top:

Fast-forward or fast-reverse the track with extra speed when Vinyl mode is on.

Serato DJ Pro

The playback position skips in sync with the beat when Vinyl mode is off (Skip mode).

- Skip mode can't be used with tracks that have no beatgrid set. For details on setting beatgrids, see the Serato DJ Pro software manual.
- To use Skip mode, open the **[DJ PREFERENCE]** tab of the **[SETUP]** menu in Serato DJ Pro > **[SYNC MODE]** and select **[Smart Sync]**.

Mixer section

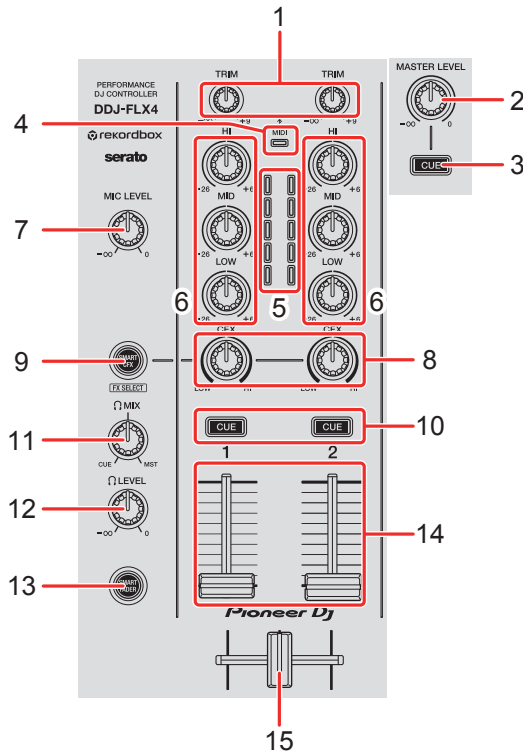

❖ Using rekordbox for Mac/Windows or rekordbox for iOS/Android

1 TRIM knobs

Adjust the volume of each channel's sound.

2 MASTER LEVEL knob

Adjusts the volume of the master output sound.

3 Headphones CUE button (master)

Press:

Plays the master sound through your headphones.

4 Bluetooth MIDI indicator

Flashes: The iOS/Android device is not connected via Bluetooth.

Lights up: The iOS/Android device is connected via Bluetooth.

Part names and functions

Turns off: The unit has recognized the connection with a DJ application using the USB cable.

- When using rekordbox for iOS/Android with the unit being powered via the USB port of your PC/Mac, do not start a DJ application on your PC/Mac.

5 Channel level indicators

Indicate the volume of the sound of the respective channels before it passes through the channel faders.

6 EQ (HI, MID, LOW) knobs

Boost or reduce the relevant frequency for the selected channel.

7 MIC LEVEL knob

Adjusts the volume of input sound from the **[MIC]** input terminal.

8 CFX knobs

Mac/Windows

When the **[SMART CFX]** button is off:

Control Sound Color FX for each channel.

When a knob is set to the center position, the sound is unchanged.

When the **[SMART CFX]** button is on:

Control Smart CFX for each channel.

When a knob is set to the center position, the sound is unchanged.

iOS/Android

When the **[SMART CFX]** button is off:

The sound is unchanged.

When the **[SMART CFX]** button is on:

Control Sound Color FX for each channel.

When a knob is set to the center position, the sound is unchanged.

9 SMART CFX button

Press:

Mac/Windows

Turns Smart CFX mode on/off.

iOS/Android

Turns Sound Color FX on/off.

[SHIFT] + press:

Mac/Windows

Changes the preset for Smart CFX.

iOS/Android

Changes the Sound Color FX type.

10 Headphones CUE buttons (channel)

Press:

Play the sound of the relevant channel through your headphones.

Mac/Windows

[SHIFT] + press:

Hold the **[SHIFT]** button and tap the headphones **[CUE]** button to set the tempo of the respective deck in time with your tapping. (Tapping function)

11 HEADPHONES MIX knob

Adjusts the monitor volume balance between sounds from the channels which have the headphones **[CUE]** button pressed, and the master channel.

12 HEADPHONES LEVEL knob

Adjusts the level of the headphones sound.

13 SMART FADER button

Turns Smart Fader mode on/off.

14 Channel faders

Slide:

Adjust the volume of the sound for each channel.

[SHIFT] + slide:

Triggers Fader Start.

15 Crossfader

Slide:

Adjusts the sound balance between the left and right channels depending on the crossfader curve setting.

[SHIFT] + slide:

Triggers Fader Start.

❖ Using Serato DJ Lite

1 TRIM knobs

Adjust the volume of each channel's sound.

2 MASTER LEVEL knob

Adjusts the volume of the master output sound.

3 Headphones CUE button (master)

Press:

Plays the master sound through your headphones.

4 Bluetooth MIDI indicator

Flashes: The iOS/Android device is not connected via Bluetooth.

Lights up: The iOS/Android device is connected via Bluetooth.

Turns off: The unit has recognized the connection with a DJ application using the USB cable.

5 Channel level indicators

Indicate the volume of the sound of the respective channels before it passes through the channel faders.

Part names and functions

6 EQ (HI, MID, LOW) knobs

Boost or reduce the relevant frequency for the selected channel.

7 MIC LEVEL knob

Adjusts the volume of input sound from the **[MIC]** input terminal.

8 CFX knobs

When the **[SMART CFX]** button is off:

Control the filter effect for each channel.

When a knob is set to the center position, the sound is unchanged.

Turn counterclockwise:

Gradually decreases the low-pass filter's cutoff frequency.

Turn clockwise:

Gradually increases the high-pass filter's cutoff frequency.

When the **[SMART CFX]** button is on:

Control Smart CFX for each channel.

When a knob is set to the center position, the sound is unchanged.

9 SMART CFX button

Press:

Turns Smart CFX mode (Preset 1) on/off.

[SHIFT] + press:

Turns Smart CFX mode (Preset 2) on/off.

10 Headphones CUE buttons (channel)

Press:

Play the sound of the relevant channel through your headphones.

[SHIFT] + press:

Hold the **[SHIFT]** button and tap the headphones **[CUE]** button to set the tempo of the respective deck in time with your tapping. (Tapping function)

Part names and functions

11 HEADPHONES MIX knob

Adjusts the monitor volume balance between sounds from the channels which have the headphones **[CUE]** button pressed, and the master channel.

12 HEADPHONES LEVEL knob

Adjusts the level of the headphones sound.

13 SMART FADER button

Press:

Turns Smart Fader mode (Preset 1) on/off.

[SHIFT] + press:

Turns Smart Fader mode (Preset 2) on/off.

14 Channel faders

Slide:

Adjust the volume of the sound for each channel.

[SHIFT] + slide:

Triggers Fader Start.

15 Crossfader

Slide:

Adjusts the sound balance between the left and right channels depending on the crossfader curve setting.

[SHIFT] + slide:

Triggers Fader Start.

Effects section

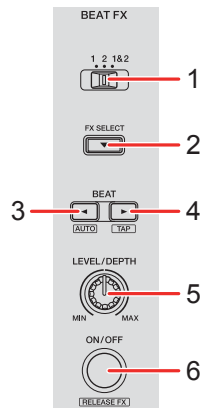

❖ Using rekordbox for Mac/Windows or rekordbox for iOS/Android

1 BEAT FX CH SELECT switch

Slide:

Changes the channel that Beat FX will be applied to.

2 BEAT FX SELECT button

Press:

Changes the Beat FX each time the button is pressed.

[SHIFT] + press:

Changes the Beat FX in the reverse order each time the button is pressed.

3 BEAT ◀ button

Press:

Decreases the number of beats for synchronizing the Beat FX sound each time the button is pressed.

[SHIFT] + press:

Sets the Beat FX Tempo mode to BPM Auto mode. The track's BPM is used as the basis for the Beat FX tempo.

4 **BEAT ► button**

Press:

Increases the number of beats for synchronizing the Beat FX sound each time the button is pressed.

[SHIFT] + press:

Sets the Beat FX Tempo mode to BPM Tap mode. The BPM used as the basis for Beat FX is set in time with your tapping of the button.

5 **BEAT FX LEVEL/DEPTH knob**

Adjusts the parameter of Beat FX.

6 **BEAT FX ON/OFF button**

Press:

Turns Beat FX on/off.

[SHIFT] + press:

Turns Release FX on/off.

❖ **Using Serato DJ Lite**

1 **FX CH SELECT switch**

Serato DJ Pro

Slide:

Changes the channel that effects will be applied to.

2 **FX SELECT button**

Press:

Changes the FX each time the button is pressed.

[SHIFT] + press:

Changes the FX in the reverse order each time the button is pressed.

3 **BEAT ◀ button**

Press:

Decreases the number of beats for synchronizing the FX sound each time the button is pressed.

[SHIFT] + press:

Sets the FX Tempo mode to BPM Auto mode. The track's BPM is used as the basis for the FX tempo.

4 **BEAT ▶ button**

Press:

Increases the number of beats for synchronizing the FX sound each time the button is pressed.

[SHIFT] + press:

Sets the FX Tempo mode to BPM Tap mode. The BPM used as the basis for FX is set in time with your tapping of the button.

5 **FX LEVEL/DEPTH knob**

Adjusts the parameter of FX.

6 **FX ON/OFF button**

Press:

Turns FX on/off.

Rear panel

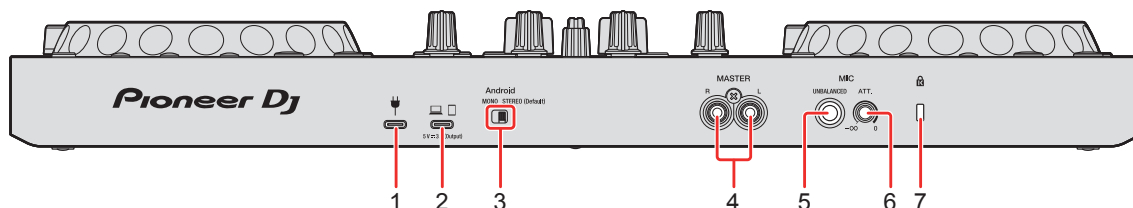

1 USB port (for power supply)

Connection for a USB power adapter (not supplied) or mobile battery (not supplied).

- Use a USB cable certified to the appropriate standard.
- When using a USB hub, be sure it's a product recommended by the manufacturer of your PC/Mac.

2 USB port (for device connection)

Connection for a PC/Mac/iOS/Android device.

- Be sure to use the USB cable specified below.
 - To connect to a device with a USB Type-C port: use the USB cable supplied with the unit
 - To connect to a device with a USB Type-A port: use a USB cable certified to the appropriate standard with a length of 3 m or less
 - To connect to a device with a Lightning terminal: use an Apple certified cable with a length of 3 m or less
- When using a USB hub, be sure it's a product recommended by the manufacturer of your PC/Mac.

3 Android MONO/STEREO switch

When connecting to an Android device, select the audio output format.

- Depending on the Android device, stereo sound may not output correctly. In some cases, the Master output sound may be distorted or sound may not output from the headphones. In that case, slide this switch to **[MONO]**.
- **[MONO]**: Sound plays in mono.
- **[STEREO (Default)]**: Sound plays in stereo (Default).

4 **MASTER output terminals (RCA pin jack type)**

Connection for a powered speaker, a power amplifier, etc.

- Compatible with RCA pin jack-type unbalanced outputs.

5 **MIC input terminal (1/4" TS Jack)**

Connection for a microphone.

- Only a phone plug (1/4") can be used.
- Only an unbalanced input can be used.

6 **MIC ATT. (Attenuator) knob**

Adjusts the volume of input sound from the **[MIC]** input terminal.

- Depending on the microphone, the gain of microphone sound differs. Use this knob to adjust the volume for your microphone before using it. While DJing, use the **[MIC LEVEL]** knob on the top panel to adjust the microphone volume.

7 **Kensington security slot**

Connection for a cable lock for security.

Front panel

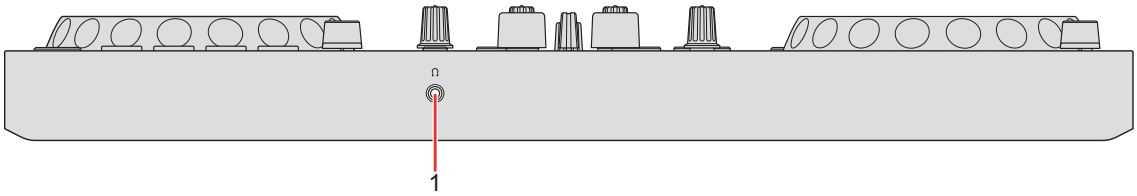

1 (headphones) output terminal

Connection for your headphones.

Stereo mini phone plugs (ø 3.5 mm) can be used with the unit.

- Only use headphones with 32 Ω or more impedance. Headphones with impedance lower than 32 Ω won't work with the unit.

Connections

- Be sure to disconnect the USB cable before connecting different devices or changing connections.
Refer to the instruction manuals for devices to be connected.
- For connection to PC/Mac or a mobile device, be sure to use the USB cable specified below.
 - To connect to a device with a USB Type-C port: use the USB cable supplied with the unit
 - To connect to a device with a USB Type-A port: use a USB cable certified to the appropriate standard with a length of 3 m or less
 - To connect to a device with a Lightning terminal: use an Apple certified cable with a length of 3 m or less
- When using a USB hub, be sure it's a product recommended by the manufacturer of your PC/Mac.
- When connecting to a PC/Mac, you can use the unit with a single connection to your computer (USB bus power). This unit can't be used with USB bus power in the following situations:
 - The power supply capacity of the USB port on your PC/Mac is too low.
 - Your PC/Mac is connected with other devices.
 - The impedance of the connected headphones is lower than 32 Ω .
 - A mono-jack plug is connected to the headphones output terminal.
- When using the unit with a mobile device, you can connect a USB power adapter or mobile battery to power the unit.
- When using the unit with a mobile device with a Micro USB Type-B port, connect it via Bluetooth.
When connecting with a USB cable, we can't guarantee proper operation of the unit.

- When using the unit with a USB power adapter or mobile battery connected to the USB port (for power supply), make sure it has a maximum voltage of 24V or less and DC 9V 3A.
Use a USB cable certified to the appropriate standard.
Use a mobile battery without a power-saving function.
- The **[MIC]** input terminal only supports an unbalanced input.
When not using the microphone, turn the **[MIC LEVEL]** knob to the minimum level.

Connection examples

Connecting input / output terminals

Rear panel

❖ For PC/Mac

- (1) PC/Mac
- (2) Powered speakers, power amplifier, etc.
- (3) Microphone

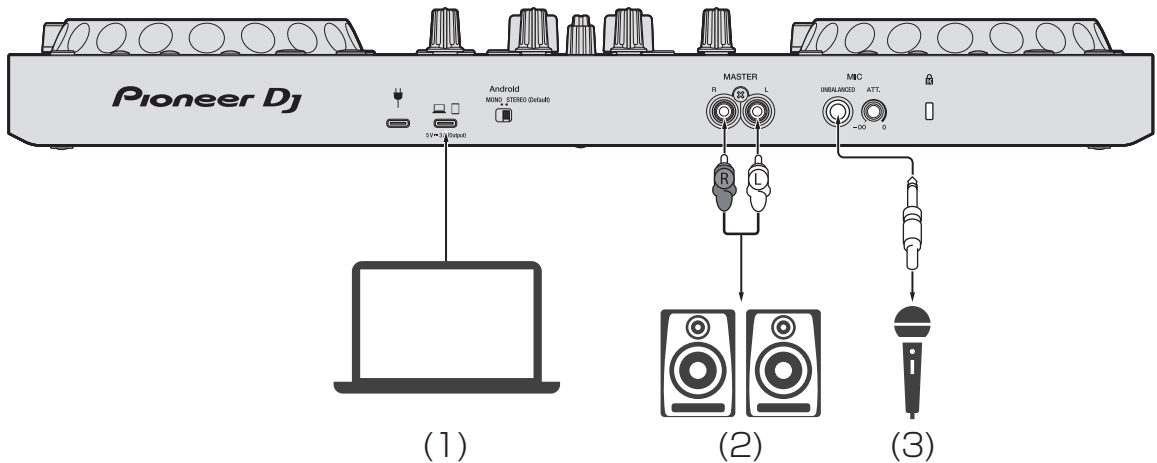

❖ For a mobile device

- (1) USB power adapter, mobile battery
- (2) Mobile device
- (3) Powered speakers, power amplifier, etc.
- (4) Microphone

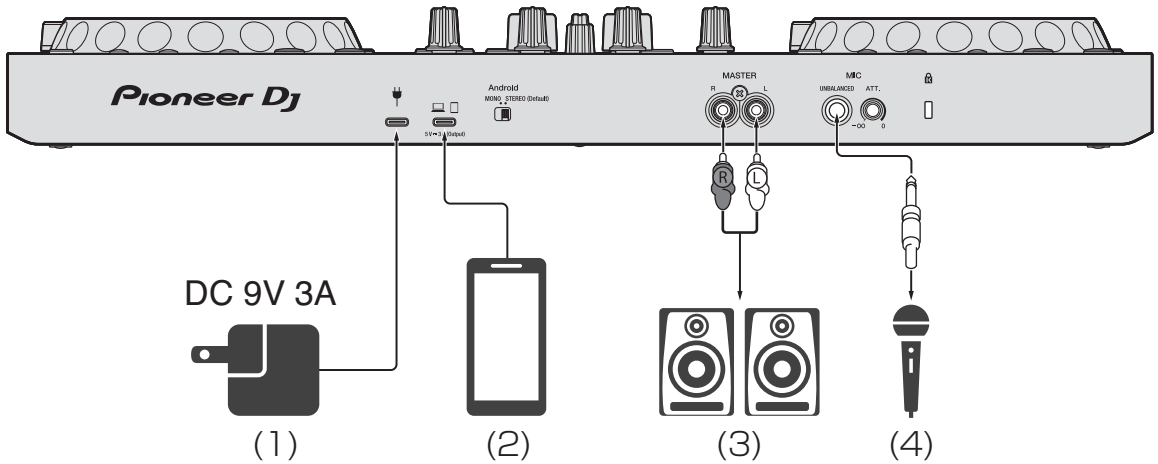

Front panel

- (1) Headphones

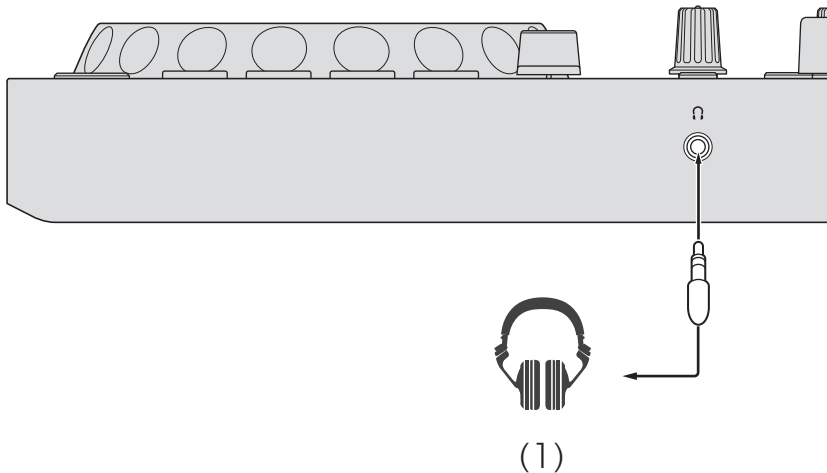

Connecting

- 1 Connect your headphones to the headphones output terminal.

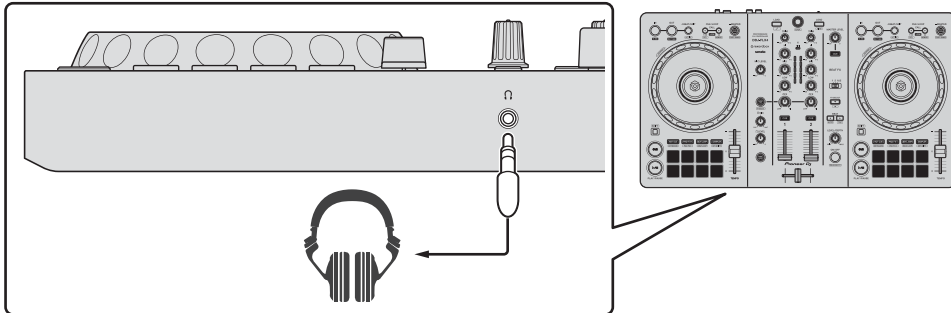

- Only connect headphones with 32 Ω or more impedance. Headphones with impedance lower than 32 Ω won't work with the unit.

- 2 Connect powered speakers, a power amplifier, etc. to the **[MASTER]** output terminals.

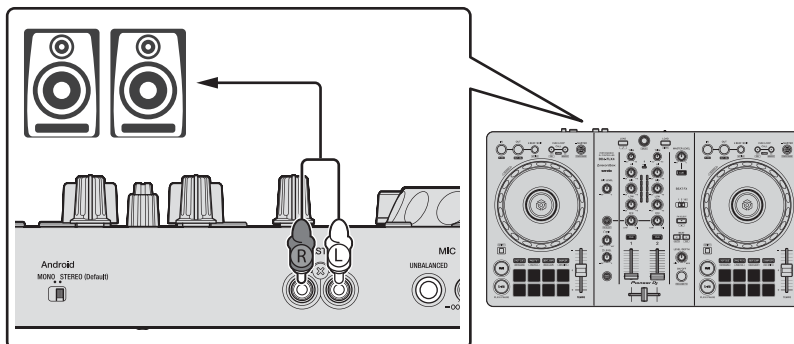

- 3 Connect your PC/Mac or mobile device to the USB port (for device connection) via a USB cable.

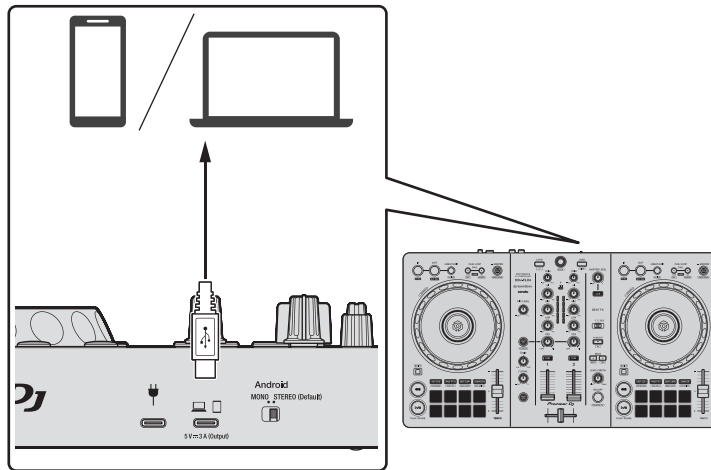

- 4 Turn on your PC/Mac or mobile device.
- 5 When using with a mobile device, connect a USB power adapter or mobile battery to the USB port (for power supply).
- 6 Turn on the devices connected to the terminals (powered speakers, microphone, etc.).

Connecting via Bluetooth

You can connect your mobile device via Bluetooth.

Sound does not output from the unit via Bluetooth. Instead, connect a cable from the mobile device to an audio output device before use.

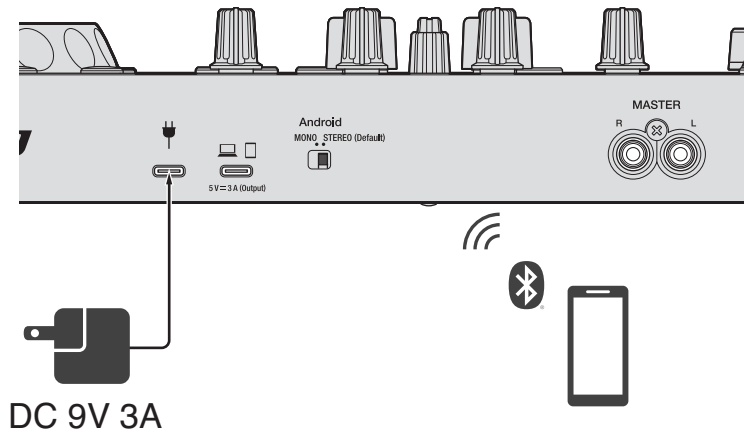

❖ Connecting to an audio device (example 1)

In this example, the master sound plays in stereo and there is no sound output to the headphones.

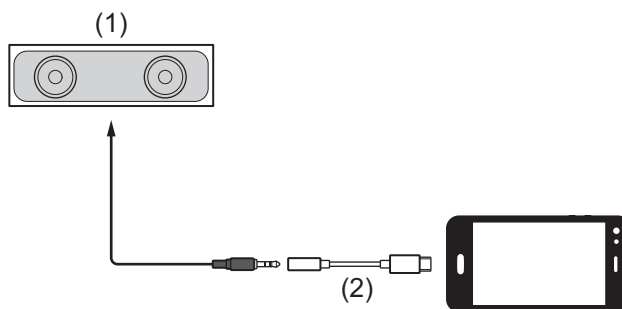

(1) Speaker with built-in amplifier, etc.

(2) USB/Lightning to 3.5 mm headphones jack (not supplied)

❖ Connecting to an audio output device (example 2)

In this example, the master sound and the headphones monitor sound both play in mono.

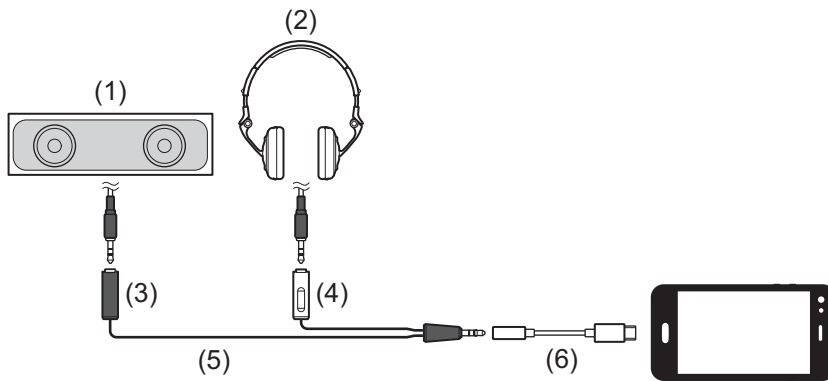

- (1) Speaker with built-in amplifier, etc.
- (2) Headphones
- (3) Plug for the speaker with built-in amplifier, etc.
- (4) Plug for the headphones
- (5) Split cable (not supplied)
- (6) USB/Lightning to 3.5 mm headphones jack (not supplied)

When connecting via Bluetooth, you'll need to make the correct setting in rekordbox for iOS/Android.

➔ Read more: Starting rekordbox for iOS/Android (page 109)

rekordbox for Mac/Windows

Installing rekordbox for Mac/Windows

Getting started with rekordbox for Mac/Windows

If you're using rekordbox for Mac/Windows for the first time, download the latest version from rekordbox.com and install it in the following way. If you already have rekordbox for Mac/Windows installed, update to the latest version using the Update Manager which you'll see when you start rekordbox for Mac/Windows.

- You are responsible for preparing your PC/Mac, network devices, and other elements.

Installing rekordbox for Mac/Windows

Procedures may differ depending on the operating system (OS) of your PC/Mac.

❖ Installing (Mac)

Do not connect the unit to your Mac until installation is complete.

- Close all programs on your Mac.
- 1 Unzip the downloaded rekordbox for Mac/Windows software file.
 - 2 Double-click the unzipped software file to launch the installer.

rekordbox for Mac/Windows

- 3 Read the terms of the License Agreement carefully and if you agree to them, click **[Agree]**.

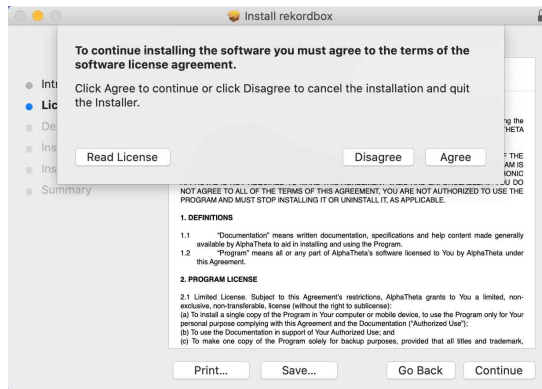

- If you do not agree to the contents of the License Agreement, click **[Disagree]** to cancel the installation.

- 4 When the screen for completing the installation appears, click **[Close]** to end the installation.

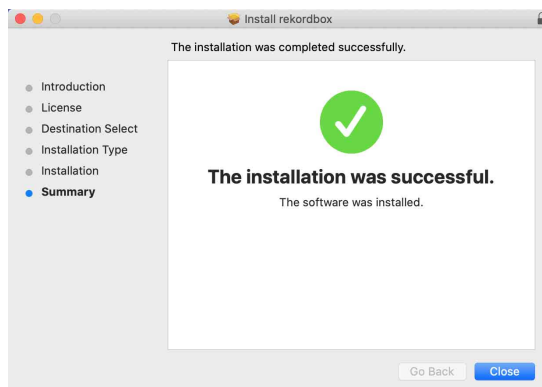

❖ Installing (Windows)

Do not connect the unit to your PC until installation is complete.

- Log into your PC as an administrator before starting the installation.
- Close all programs on your PC.

- 1 Unzip the downloaded rekordbox for Mac/Windows software file.
- 2 Double-click the unzipped software file to launch the installer.

rekordbox for Mac/Windows

- 3 Read the terms of the License Agreement carefully and if you agree to them, select **[Agree]**, then click **[Next]**.

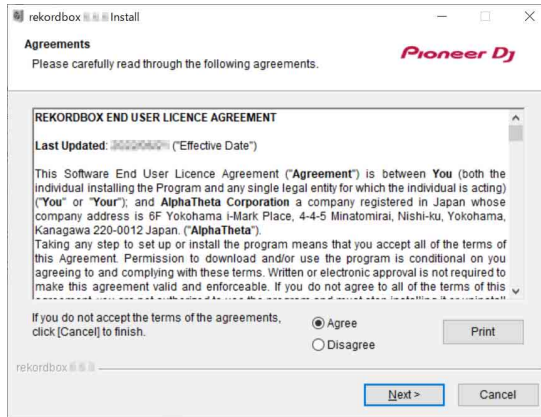

- If you do not agree to the contents of the license agreement, click **[Cancel]** to cancel the installation.
- After specifying the destination, the installation will start. When the installation is finished, a completion message will be displayed.

- 4 Click **[Finish]** to complete the installation.

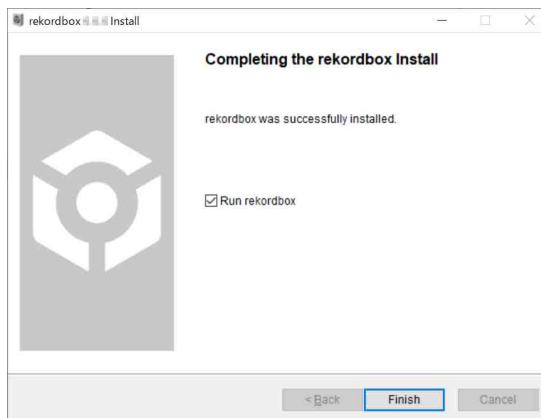

Installation is complete.

Basic use

Starting rekordbox for Mac/Windows

You need to register a Pioneer DJ account to use rekordbox for Mac/Windows.

For details, see “rekordbox Introduction”.

For Mac

In Finder, open the **[Applications]** folder, then double-click the **[rekordbox 6] > [rekordbox.app]** icon.

For Windows 11

In the **[Start]** menu, open the **[All apps]** screen, then click the **[rekordbox 6]** icon under **[Pioneer]**.

For Windows 10

In the **[Start]** menu, click the **[rekordbox 6]** icon under **[Pioneer]**.

Checking audio setup

Check that the **[Audio]** settings in **[Preferences]** in rekordbox for Mac/Windows are set as follows:

For Mac

[Audio]: [DDJ-FLX4]

[Output channels]:

[Master Output]: [DDJ-FLX4 : MASTER + audio device name on Mac]

[Headphones Output]: [DDJ-FLX4 : PHONES]

- When PC MASTER OUT is off, **[Master Output]** in the **[Audio]** setting is **[DDJ-FLX4 : MASTER]**.

For Windows

[Audio]: [DDJ-FLX4 WASAPI]

[Output channels]:

[Master Output]: [DDJ-FLX4 WASAPI : MASTER + audio device name on PC]

[Headphones Output]: [DDJ-FLX4 WASAPI : PHONES]

- When PC MASTER OUT is off, **[Master Output]** in the **[Audio]** setting is **[DDJ-FLX4 WASAPI : MASTER]**.
- PC MASTER OUT is a function that can output the master sound of rekordbox for Mac/Windows from the speaker(s) of the connected PC/Mac. By default, PC MASTER OUT is set to on.
- To cancel outputting the master sound of rekordbox for Mac/Windows from the speaker(s) of the connected PC/Mac, click  in the top-right area of the rekordbox for Mac/Windows screen so its light switches off.

Adding music files into your Collection

The **[Collection]** screen contains a list of music files managed by rekordbox for Mac/Windows.

Add music files on your PC/Mac to your Collection so the software can analyze them and they can be used in rekordbox for Mac/Windows.

- 1 Click **[Collection]** on the tree view.
A list of tracks in your **[Collection]** is displayed.
- 2 Open Finder (Mac) or Explorer (Windows) and drag and drop music files, or folders containing music files, into the track list.
Music files are added into the **[Collection]** and analysis for the music files begins. Wait until analysis of all music files is complete.

Loading an audio track onto a deck

The following explains how to load a track onto deck 1 as an example.

Turn the rotary selector to select a track in your **[Collection]** and press the **[LOAD]** button for deck 1 (left).

The track loads onto deck 1.

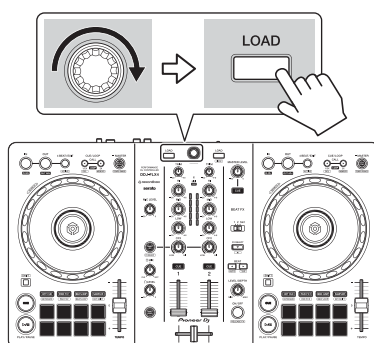

Playing a track

This section explains how to play sound from deck 1 (left) as an example.

- 1 Set the positions of the knobs, etc. as follows:
 - **[TRIM]** knob: turned fully counterclockwise
 - EQ **[HI/MID/LOW]** knobs: center position (12 o'clock)
 - **[CFX]** knob: center position
 - Channel fader: bottom position
 - **[MASTER LEVEL]** knob: turned fully counterclockwise
 - Crossfader: center position
- 2 Press the **[PLAY/PAUSE ▶/III]** button to play the track.

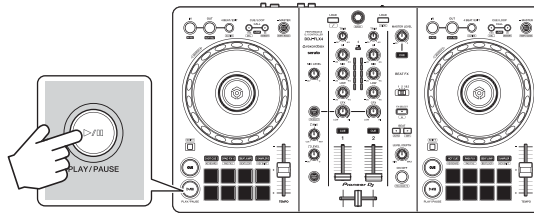

- 3 Turn the **[TRIM]** knob.

Adjust the **[TRIM]** knob so the channel level indicator lights up orange at the loudest part of the track.

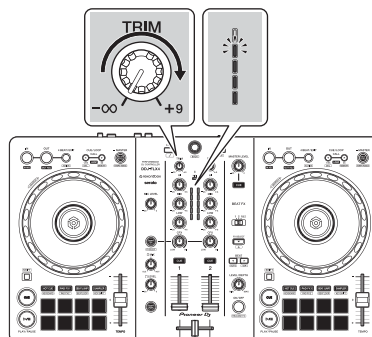

rekordbox for Mac/Windows

4 Move the channel fader to the top.

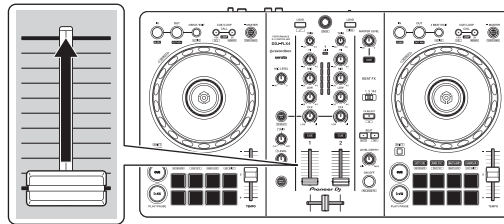

5 Turn the **[MASTER LEVEL]** knob to adjust the volume of the speakers to a level you're happy with.

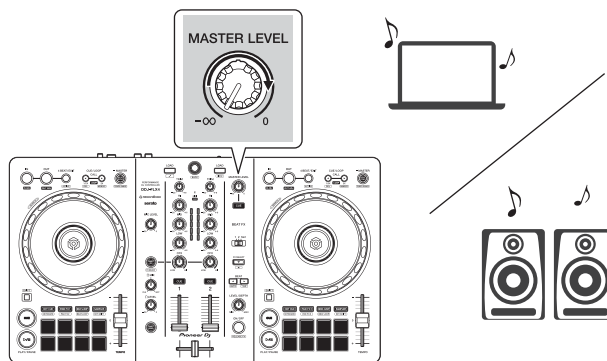

- If you're outputting sound from the speaker of your PC/Mac, adjust the speaker volume on the PC/Mac instead of using the **[MASTER LEVEL]** knob.
- If you can't output sound from the **[MASTER]** output terminals or the unit isn't recognized by your PC/Mac, refer to the **[FAQ]** on the Pioneer DJ support website.

pioneerdj.com/support/

Monitoring with headphones

This section explains how to play sound from deck 1 (left) as an example.

- 1 Set the positions of knobs, etc. as shown below.
 - **[HEADPHONES MIX]** knob: Center
 - **[HEADPHONES LEVEL]** knob: Turned fully counterclockwise
- 2 Press the headphones **[CUE]** button for channel 1.
- 3 Turn the **[HEADPHONES LEVEL]** knob.
Adjust the headphones volume to a level you're happy with.

Quitting rekordbox for Mac/Windows

Click the **[x]** button or select **[Exit]** from the **[File]** menu.

Turning off the unit

Disconnect the USB cable to turn off the unit.

Advanced use

Using 4 Beat Loop

While a track is playing, press the **[4 BEAT/EXIT]** button.

Loop playback starts with 4 beats from the point where you press the button.

- When the Quantize function is turned on, you might notice a slight delay as the loop synchronizes to the beat.

❖ Canceling loop playback

Press the **[4 BEAT/EXIT]** button.

When the loop out point is reached, the rest of the track continues to play without returning to the loop in point.

Using Manual Loop

You can use Manual Loop to choose the section you want to loop in a track.

- When the Quantize function is turned on, you might notice a slight delay as the loop synchronizes to the beat.
- 1 During playback, press the **[IN]** button at the point you want to start looping (the loop in point).
 - 2 Press the **[OUT]** button at the point you want the loop to end (the loop out point).
Loop playback starts.

❖ Cutting the loop

Press the **[CUE/LOOP CALL ◀]** button during loop playback.

Each time you press the button, the loop cuts in half.

- You can cut the loop length in half even during 4 Beat Loop playback.

❖ Extending the loop

Press the **[CUE/LOOP CALL ▶]** button during loop playback.

Each time you press the button, the loop doubles in length.

- You can double the loop length even during 4 Beat Loop playback.

❖ Canceling a loop

Press the **[4 BEAT/EXIT]** button.

The rest of the track continues to play without returning to the loop in point.

❖ Changing the loop in point

Press the **[IN]** button and turn the jog wheel during loop playback.

The loop in point changes.

❖ Changing the loop out point

Press the **[OUT]** button and turn the jog wheel during loop playback.

The loop out point changes.

Using the Performance Pads

❖ Using Hot Cues

You can start playback instantly from the position where a Hot Cue is set. Loops can also be set and called up instantly.

- Up to 16 Hot Cues can be set and saved for each track in rekordbox for Mac/Windows. On the unit, up to 8 Hot Cues can be set and saved per track.

Setting and calling up a Hot Cue

- 1 Press the **[HOT CUE]** mode button.

The unit enters Hot Cue mode.

- 2 When the track is playing or paused, press a Performance Pad to set a Hot Cue.

Hot Cues are set to Performance Pads as follows:

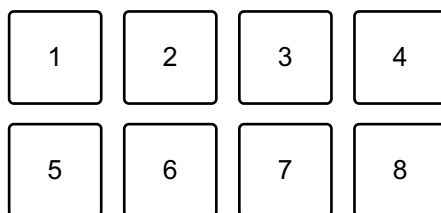

1: Hot Cue A, 2: Hot Cue B, 3: Hot Cue C, 4: Hot Cue D,

5: Hot Cue E, 6: Hot Cue F, 7: Hot Cue G, 8: Hot Cue H

- 3 Press a Performance Pad you've set a Hot Cue for.

Playback starts from the Hot Cue point.

- You can clear Hot Cues by pressing a Performance Pad while holding the **[SHIFT]** button.

Setting and calling up 4 Beat Loop

- 1 Press the **[HOT CUE]** mode button.
The unit enters Hot Cue mode.
- 2 Press and hold the **[4 BEAT/EXIT]** button during playback.
A loop with 4 beats is set at the position where you pressed the button, and loop playback starts.
- 3 Press a Performance Pad to set a loop during loop playback.
- 4 Press the Performance Pad.
Loop playback starts from the loop in point.
 - You can clear the loop by pressing the Performance Pad while holding the **[SHIFT]** button.

Setting and calling up Manual Loop

- 1 Press the **[HOT CUE]** mode button.
The unit enters Hot Cue mode.
- 2 Press the **[IN]** button during playback, and press the **[OUT]** button.
Loop playback starts.
- 3 Press a Performance Pad to set a loop during the loop playback.
- 4 Press the Performance Pad.
Loop playback starts from the loop in point.
 - You can clear the loop by pressing the Performance Pad while holding the **[SHIFT]** button.

❖ Using Pad FX

You can add a wide range of effects to your performances simply by pressing and releasing the Performance Pads.

- 1 Turn on Pad FX mode 1 or Pad FX mode 2.
 - Pad FX mode 1: Press the **[PAD FX1]** mode button.
 - Pad FX mode 2: Press the **[PAD FX1]** mode button while holding the **[SHIFT]** button.

Effects are set to the Performance Pads as follows:

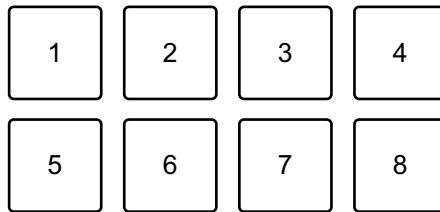

Without holding the **[SHIFT]** button (Pad FX mode 1)

1: Effect A, 2: Effect B, 3: Effect C, 4: Effect D,
5: Effect E, 6: Effect F, 7: Effect G, 8: Effect H

While holding the **[SHIFT]** button (Pad FX mode 1)

1: Effect I, 2: Effect J, 3: Effect K, 4: Effect L,
5: Effect M, 6: Effect N, 7: Effect O, 8: Effect P

Without holding the **[SHIFT]** button (Pad FX mode 2)

1: Effect Q, 2: Effect R, 3: Effect S, 4: Effect T,
5: Effect U, 6: Effect V, 7: Effect W, 8: Effect X

While holding the **[SHIFT]** button (Pad FX mode 2)

1: Effect Y, 2: Effect Z, 3: Effect AA, 4: Effect AB,
5: Effect AC, 6: Effect AD, 7: Effect AE, 8: Effect AF

- 2 Press and hold down a Performance Pad, or press and hold down a Performance Pad while holding the **[SHIFT]** button.

The effect turns on. The sound changes according to the type of effect and the number of beats in the settings assigned to that pad.

- 3 Release the Performance Pad.

The effect turns off.

Using Release FX of Pad FX

You need to assign a Release FX to a Performance Pad in advance.

- 1 Press and hold down a Performance Pad that has an effect other than a Release FX assigned to it, or press and hold down a Performance Pad while holding the **[SHIFT]** button.

The effect turns on. The sound changes according to the type of effect and the number of beats in the settings assigned to that pad.

- 2 Press the Performance Pad that has a Release FX assigned to it, and release it.

Or, press a Performance Pad while holding the **[SHIFT]** button, and release it.

The effect turns off, and the Release FX is added.

❖ Using Beat Jump

You can move the playback position instantly, without breaking the rhythm of the track that's playing.

- 1 Press the **[BEAT JUMP]** mode button.

The unit enters Beat Jump mode.

The number of beats set to the Performance Pads are as follows (Default):

1	2	3	4
5	6	7	8

rekordbox for Mac/Windows

1: 1 beat (left direction), 2: 1 beat (right direction), 3: 2 beats (left direction),
4: 2 beats (right direction), 5: 4 beats (left direction), 6: 4 beats (right direction),
7: 8 beats (left direction), 8: 8 beats (right direction)

2 Press Performance Pad 7 or 8 while holding the **[SHIFT]** button to change the number of beats set to the Performance Pad.

When pressing Performance Pad 7 while holding the **[SHIFT]** button, the number of beats decreases.

When pressing Performance Pad 8 while holding the **[SHIFT]** button, the number of beats increases.

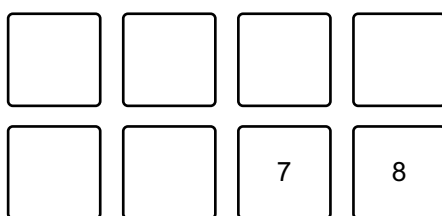

7: Number of beats goes down, 8: Number of beats goes up

3 Press a Performance Pad.

- Pad 1, 3, 5 or 7: The playback position is moved to the left by the number of beats set on the pad.
- Pad 2, 4, 6 or 8: The playback position is moved to the right by the number of beats set on the pad.

❖ Using Sampler

You can use the Performance Pads to play tracks or sounds assigned to the Sampler slots.

Preparing to use Sampler

Click the  button at the top-left of the rekordbox for Mac/Windows screen to display the **[SAMPLER]** panel.

Loading a track into a Sampler slot

- 1 Press the **[SAMPLER]** mode button.
The unit enters Sampler mode.
- 2 Click the button at the right of **[BANK]** on the **[SAMPLER]** panel in rekordbox for Mac/Windows to change the Sampler bank.



In rekordbox for Mac/Windows, the sampler has 4 banks, and each bank has 16 slots.

- 3 Press the rotary selector to move the cursor to the track list.
- 4 Turn the rotary selector.
Select a track you want to load into a Sampler slot.
- 5 Press a Performance Pad while holding the **[SHIFT]** button.
The selected track is loaded into the Sampler slot.
 - Loading a sound into a slot that already has a sound loaded may not be possible depending on the **[Preferences]** settings in rekordbox for Mac/Windows. You may need to clear the slot before loading the new sound.

Playing Sampler sounds with Performance Pads

- 1 Press the **[SAMPLER]** mode button.
The unit enters Sampler mode.
- 2 Click the button to the right of **[BANK]** on the **[SAMPLER]** panel in rekordbox for Mac/Windows to change the Sampler bank.
- 3 Turn the  **[GAIN]** on the **[SAMPLER]** panel to adjust the Sampler volume.
- 4 Press a Performance Pad.
The track or sound assigned to the relevant slot is played.

rekordbox for Mac/Windows

- Sampler slots are set to Performance Pads as follows. (The slots in brackets are for when the Pad mode of deck 2 is set to Sampler mode.)

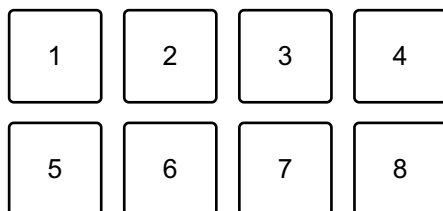

1: Slot 1 (slot 9), 2: Slot 2 (slot 10), 3: Slot 3 (slot 11), 4: Slot 4 (slot 12),
5: Slot 5 (slot 13), 6: Slot 6 (slot 14), 7: Slot 7 (slot 15), 8: Slot 8 (slot 16)

- 5 During Sampler playback, press the Performance Pad again.
The sound plays from the beginning again.
- 6 Press a Performance Pad while holding the **[SHIFT]** button during Sampler playback.
The sound of the slot that is currently playing stops.

❖ Using Keyboard mode

Use Performance Pads to play a Hot Cue in different pitches, as if you're using a keyboard.

- 1 Press the **[HOT CUE]** mode button while holding the **[SHIFT]** button.
The unit enters Keyboard mode.
- 2 Press a Performance Pad.
Select the Hot Cue you want to use with Keyboard mode.
 - If no Hot Cue is set, the current playback position is set as a Hot Cue. After selecting the Hot Cue which you set, the Hot Cue is used with Keyboard mode.
 - To reselect a Hot Cue, press the **[HOT CUE]** mode button while holding the **[SHIFT]** button.

rekordbox for Mac/Windows

When the Hot Cue is selected, the various pitches are set to the Performance Pads as follows (Default):

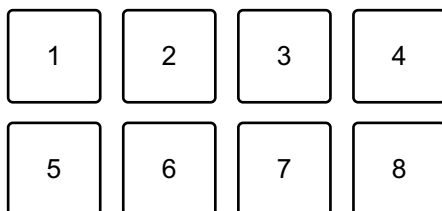

1: +4 Semitones, 2: +5 Semitones, 3: +6 Semitones, 4: +7 Semitones,
5: ± 0 Semitones, 6: +1 Semitone, 7: +2 Semitones, 8: +3 Semitones
A semitone is a unit used to determine the pitch of a sound. +1 semitone means the sound is higher in pitch than the original sound by half.

3 Press Performance Pad 7 or 8 while holding the **[SHIFT]** button to change the pitch set to the Performance Pad.

- Pad 7: The display changes and the pitch of the sound rises.
- Pad 8: The display changes and the pitch of the sound falls.

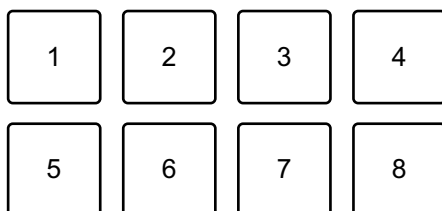

1 through 6: Delete Hot Cue, 7: Changing display, 8: Changing display

4 Press a Performance Pad.

Playback starts from the Hot Cue point, with the sound pitch assigned to that pad.

- To delete the Hot Cue, press Performance Pad 1 through 6 while holding the **[SHIFT]** button.

❖ Using Beat Loop

If you press a Performance Pad, a loop with the number of beats assigned to the pad is set. The loop keeps playing after you remove your finger from the pad.

- 1 Press the **[BEAT JUMP]** mode button while holding the **[SHIFT]** button.

The unit enters Beat Loop mode.

The number of beats set to the Performance Pads are as follows:

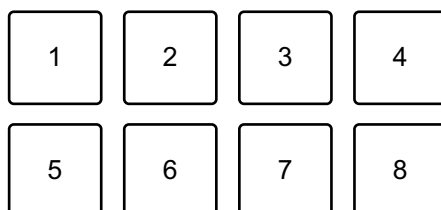

1: Beat Loop 1/4 beat, 2: Beat Loop 1/2 beat, 3: Beat Loop 1 beat,
4: Beat Loop 2 beats, 5: Beat Loop 4 beats, 6: Beat Loop 8 beats,
7: Beat Loop 16 beats, 8: Beat Loop 32 beats

- 2 Press a Performance Pad.

The loop plays with the number of beats set on that pad.

- 3 Press the same Performance Pad again.

The loop is canceled and the rest of the track continues to play.

❖ Using Key Shift

When you press a Performance Pad in Key Shift mode, the key of the track that's currently playing is changed to the pitch set to the pressed pad.

- 1 Press the **[SAMPLER]** mode button while holding the **[SHIFT]** button.

The unit enters Key Shift mode.

The various pitches are set to the Performance Pads as follows (Default):

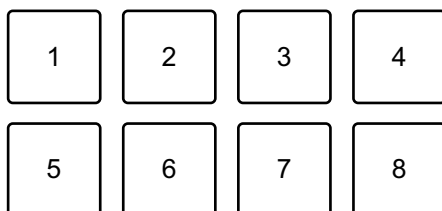

1: +4 Semitones, 2: +5 Semitones, 3: +6 Semitones, 4: +7 Semitones,
5: ± 0 Semitones, 6: +1 Semitone, 7: +2 Semitones, 8: +3 Semitones

A semitone is a unit used to determine the pitch of a sound. +1 semitone means the sound is higher in pitch than the original sound by half.

- 2 Press Performance Pad 7 or 8 while holding the **[SHIFT]** button to change the pitch set to the Performance Pad.
 - Pad 7: The display changes and the pitch of the sound rises.
 - Pad 8: The display changes and the pitch of the sound falls.

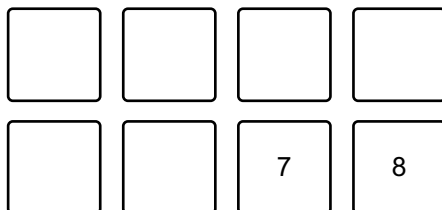

7: Changing display, 8: Changing display

- 3 Press a Performance Pad.

The track's key is changed to the pitch assigned to the pad.

Setting and calling up a cue point or loop point

❖ Setting a cue point or loop point

- 1 Pause the track and move the playback position to where you want to set a cue point or loop point.
- 2 Press the **[CUE]** button while the track is paused.
- 3 Press the **[CUE/LOOP CALL ►]** button while holding the **[SHIFT]** button.
The cue point or loop point is saved.

❖ Calling up the cue point or loop point

Press the **[CUE/LOOP CALL ►]** or **[CUE/LOOP CALL ◀]** button.
The cue point or loop point is called up.

❖ Deleting the cue point or loop point

- 1 Press the **[CUE/LOOP CALL ►]** or **[CUE/LOOP CALL ◀]** button.
The cue point or loop point is called up.
- 2 Press the **[CUE/LOOP CALL ◀]** button while holding the **[SHIFT]** button.
The cue point or loop point is deleted.

Using Fader Start

❖ Using Channel Fader Start

- 1 Set the cue point.

Pause the track at the position you want to start playback from, then press the **[CUE]** button on that deck.

- 2 While holding the **[SHIFT]** button, move the channel fader from the bottom to the top.

Playback starts from the cue point.

- If you move the channel fader back to the bottom while holding the **[SHIFT]** button during playback, the track instantly jumps back to the cue point and playback pauses. (Back Cue)

When no cue point is set, playback starts from the beginning of the track.

❖ Using Crossfader Start

- 1 Set the cue point.

Pause the track at the position you want to start playback from, then press the **[CUE]** button on that deck.

- 2 Move the crossfader all the way to the left or right side.

If you want to use Crossfader Start to trigger playback on channel 2, set the crossfader to the left side, and vice versa.

- 3 While holding the **[SHIFT]** button, move the crossfader towards the opposite side from where it's set.

Playback starts from the cue point.

- If you move the crossfader back while holding the **[SHIFT]** button during playback, the playback position instantly jumps back to the cue point and pauses. (Back Cue)

When no cue point is set, playback starts from the beginning of the track.



Analyzing tracks

Track analysis starts when you drag and drop a music file, or a folder containing music files, into the Track List in rekordbox for Mac/Windows.

- If a track is loaded to a deck before analysis is complete, it may take some time to display its BPM and waveform.
- Depending on the number of tracks, analysis may take some time.

Using Beat FX

You can apply effects that match the tempo (BPM) of the track loaded on the deck.

- 1 Click  in the top-left of the rekordbox for Mac/Windows screen to display the FX panel, and click  to choose settings for Multi mode.
- 2 Press the **[BEAT FX SELECT]** button on the unit.
The selected Beat FX changes each time you press the button:
If you press the **[BEAT FX SELECT]** button while holding the **[SHIFT]** button, the selected Beat FX changes in the reverse order.
- 3 Slide the **[BEAT FX CH SELECT]** switch.
The channel that Beat FX will be applied to changes each time you slide the switch.
 - **[1]**: Applies Beat FX to the sound of channel 1.
 - **[2]**: Applies Beat FX to the sound of channel 2.
 - **[1&2]**: Applies Beat FX to the sound of channel 1 and channel 2.
For **[1&2]**, the beat, effect type, etc. are synchronized between the unit 1 and unit 2 of Beat FX. The beat settings may not be synchronized due to differences in the BPM of the tracks loaded on the decks. Also, the synchronization doesn't work when the effect is set to Single mode.

- 4 Press the **[BEAT ◀]** or **[BEAT ▶]** button.
Set the number of beats (or parameters) synchronized to the effect sound.
- 5 Press the **[BEAT FX ON/OFF]** button.
The Beat FX is applied to the sound of the channel you set in step 3.
You can adjust the parameter of Beat FX by turning the **[BEAT FX LEVEL/DEPTH]** knob.
When Beat FX is turned on, the button flashes.
 - Press the **[BEAT FX ON/OFF]** button again to turn off Beat FX.
- 6 Press the **[BEAT FX ON/OFF]** button and release it while holding the **[SHIFT]** button.
Beat FX is turned off, and Release FX is applied.

❖ Switching Beat FX Tempo mode

To set the tempo for Beat FX, there are 2 modes you can use: BPM Auto mode and BPM Tap mode.

- The default setting is BPM Auto mode.

BPM Auto mode

The track's BPM is used as the base for the effect's tempo.

BPM Tap mode

The BPM used as the base for Beat FX is set to match the tempo at which you tap the **[BEAT ▶]** button while holding the **[SHIFT]** button.

Setting to BPM Auto mode/BPM Tap mode

Press the **[BEAT ▶]** button while holding the **[SHIFT]** button to set to BPM Tap mode.

Press the **[BEAT ◀]** button while holding the **[SHIFT]** button to set to BPM Auto mode.

Using Smart CFX

- 1 Press the **[SMART CFX]** button while holding the **[SHIFT]** button.
The preset screen for Smart CFX is displayed to change the effect type.

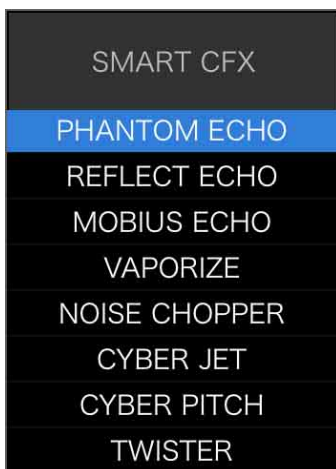

- 2 Press the **[SMART CFX]** button.
Smart CFX turns on.
- 3 Turn the **[CFX]** knob.
The effect sound, etc. changes.
 - Depending on the effect type, loops and keys are changed in addition to the effect.
 - When Smart CFX is turned on, some effects, trims, etc. can't be controlled on the rekordbox for Mac/Windows screen.

❖ Canceling Smart CFX

Press the **[SMART CFX]** button.
Smart CFX is turned off.

Using Smart Fader

- 1 Load tracks onto deck 1 and deck 2.
- 2 Press the **[SMART FADER]** button.
Smart Fader turns on.
 - When Smart Fader is turned on, Beat Sync turns on. (Beat Sync can't be canceled.)
 - When Smart Fader is turned on, some effects, EQ LOW, and Beat Sync can't be controlled on the rekordbox for Mac/Windows screen.
- 3 Slide the channel faders and crossfader to mix tracks.
 - Adjust the BPM for playback according to fader operation and the track.
 - EQ LOW is automatically adjusted according to fader operation.
 - The echo effect is automatically applied according to fader operation.
 - When sound outputs only from deck 1 due to fader operation, the BPM is adjusted to the real BPM of the track on deck 1. When sound outputs only from deck 2 due to fader operation, the BPM is adjusted to the real BPM of the track on deck 2. When sound outputs from deck 1 and deck 2 at the same volume, the BPM is adjusted to find the middle point of the difference between the BPM of the tracks on deck 1 and deck 2.
 - If the BPM of the tracks on deck 1 and deck 2 are significantly different, Smart Fader may not work properly because it is out of the tempo range.

Operation examples

(1): Deck 1, (2): Deck 2

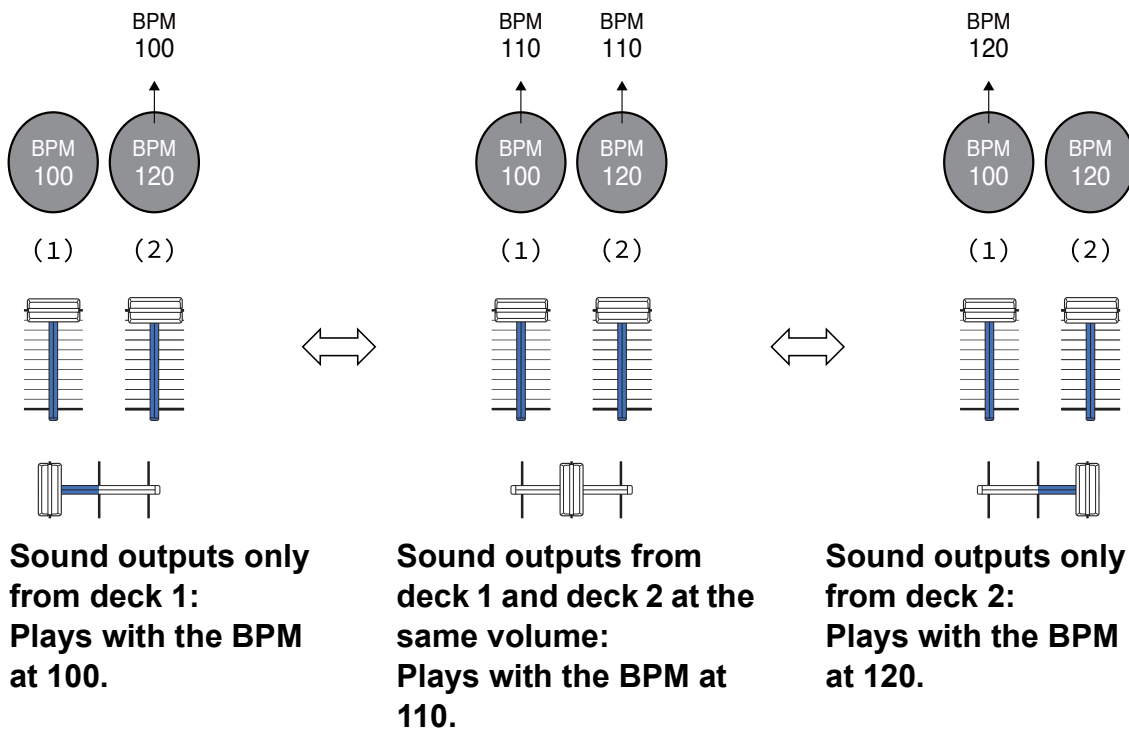

In this example, the BPM changes between 100 and 120.

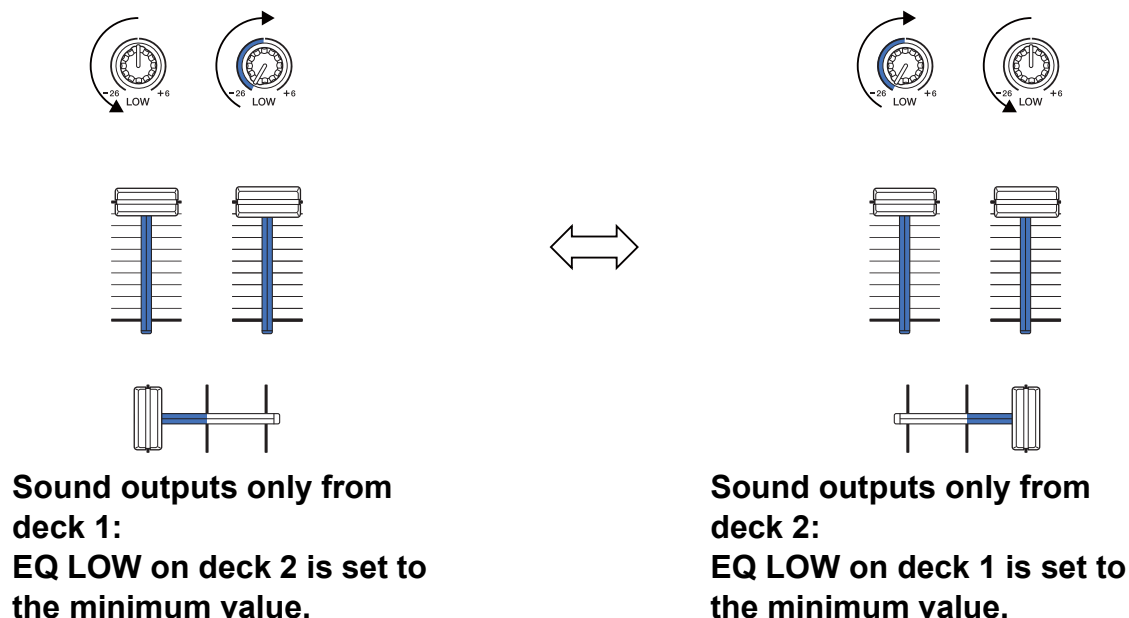

rekordbox for Mac/Windows

In this example, it changes as follows.

- Channel 1: When the crossfader position is between 1/3 and 2/3 from the left, the EQ LOW knob position changes from the center position to the minimum value.
- Channel 2: When crossfader position is between 1/3 and 2/3 from the left, the EQ LOW knob position changes from the minimum value to the center position.
- * The EQ LOW curve differs depending on the EQ LOW knob position and fader position, and mixing is automatically smooth.
- * The actual EQ LOW knob position isn't reflected on the rekordbox for Mac/Windows screen, only the sound changes.

(1): Echo effect applied

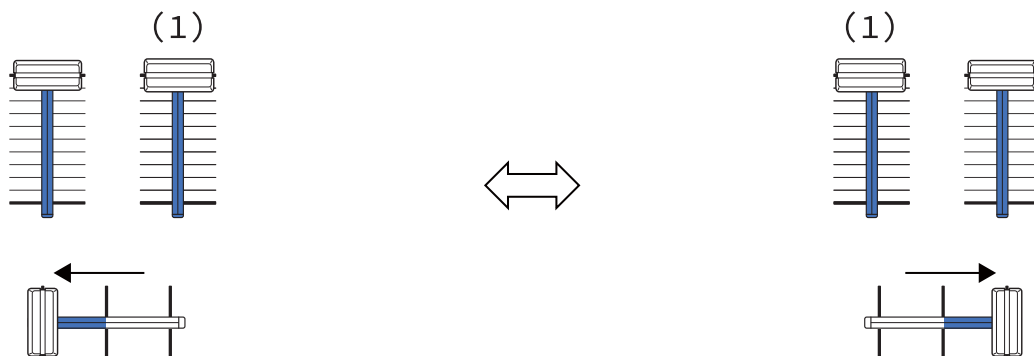

Sound outputs only from deck 1:

The echo effect is applied to the track on deck 2.

Sound outputs only from deck 2:

The echo effect is applied to the track on deck 1.

In this example, it changes as follows.

- Deck 1: The echo effect is applied when the crossfader is moved all the way to the right edge.
 - * The echo effect isn't applied when the crossfader is moved to the left starting from the right edge.
- Deck 2: The echo effect is applied when the crossfader is moved to the left edge.



- * The echo effect isn't applied when the crossfader is moved to the right starting from the left edge.
- You can select the fader to control Smart Fader in **[Preferences] > [Controller] > [Mixer] > [SMART FADER] > [Fader Used with SMART FADER]** in rekordbox for Mac/Windows.
- For Smart Fader, set the left side to channel 1 and the right side to channel 2 in the crossfader assignment.
For details about the crossfader assignment, see "rekordbox Instruction Manual".
rekordbox.com/manual

❖ Canceling Smart Fader

Press the **[SMART FADER]** button.
Smart Fader turns off.

Recording



rekordbox for Mac/Windows has a recording feature that you can use to capture your performances. For detailed instructions on recording, see the rekordbox Instruction Manual.

- 1 Click the  button at the top-left of the rekordbox for Mac/Windows screen to display the **[REC]** panel.
- 2 Click  on the **[REC]** panel in rekordbox for Mac/Windows to start recording.
 - If you click  again, recording stops.
 - When recording is complete, the file is automatically saved.
 - You can change the saving destination of files in the **[Preferences] > [Controller] > [Recordings]** tab in rekordbox for Mac/Windows.

rekordbox for Mac/Windows

- If **[Microphone Input]** in rekordbox for Mac/Windows is set to **[Low Latency Mode]**, the sound from the **[MIC]** input terminal of the unit can't be recorded. To record the sound from the **[MIC]** input terminal, set **[Microphone Input]** in rekordbox for Mac/Windows to **[Effect Mode]**.

Using a microphone

- 1 Connect a microphone to the **[MIC]** input terminal.
- 2 Click the  button at the top-right of the rekordbox for Mac/Windows screen to display the mixer panel, then click  so it lights up.
 - To output the microphone sound from the unit via a PC/Mac, you'll need to do this. To output the microphone sound from the unit another way, skip this step.
- 3 Turn the **[MIC LEVEL]** knob.
Adjust the volume of the sound output from the **[MIC]** input terminal.
 - The sound comes out at a high volume if the knob is turned all the way to the right.
- 4 Input audio to the microphone.
When outputting microphone sound from the unit via a PC/Mac, you can use the microphone EQ, microphone effect, TALKOVER, FEEDBACK REDUCER, etc.



- To output the microphone sound from this unit via a PC/Mac, set **[Microphone Input]** to **[Effect Mode]**.
 - ➔ Read: [Microphone Input] setting (page 78)
- If **[Microphone Input]** is set to **[Low Latency Mode]** in rekordbox for Mac/Windows, the microphone sound outputs from the unit another way.

rekordbox for Mac/Windows

The following shows the function differences depending on the above settings.

- MIC LEVEL knob
 - Via PC/Mac: Enabled
 - Not via PC/Mac: Enabled
- Limiter for the microphone sound output to the Master
 - Via PC/Mac: Enabled
 - Not via PC/Mac: Disabled
- Microphone EQ
 - Via PC/Mac: Enabled
 - Not via PC/Mac: Disabled
- Microphone effect
 - Via PC/Mac: Enabled
 - Not via PC/Mac: Disabled
- TALKOVER
 - Via PC/Mac: Enabled
 - Not via PC/Mac: Disabled
- FEEDBACK REDUCER
 - Via PC/Mac: Enabled
 - Not via PC/Mac: Disabled

For details about functions for the microphone, see “rekordbox Instruction Manual”.

rekordbox.com/manual

Changing the settings in rekordbox for Mac/Windows

You can change the settings of the unit in rekordbox for Mac/Windows under **[Controller]** in **[Preferences]**.

When you connect the unit to rekordbox for Mac/Windows, you can change the following settings:

[Controller] > **[Deck]** tab:

[Back Spin Length] setting

When using the Back Spin feature with the jog wheel, the length of the Back Spin is different from the length of the jog wheel rotation.

You can choose the length of the Back Spin from 3 options: short, normal, or long.

- **[short]**: Back Spin length short
- **[normal]**: Back Spin length normal
- **[long]**: Back Spin length long

[Controller] > **[Mixer]** tab:

[Fader Start] setting

Change the setting of the Fader Start function.

Select **[Activate the fader start when moving a channel fader or the crossfader while pressing the SHIFT button.]** to turn the setting on.

[CROSSFADER] > **[REVERSE]** setting

Assign the decks to different sides of the crossfader.

- **[On]**: The left side of the crossfader is assigned to **[DECK2]** and the right side is **[DECK1]**.
- **[Off]**: The left side of the crossfader is assigned to **[DECK1]** and the right side is **[DECK2]**.

[CROSSFADER] > [Cut Lag] setting

Adjust the Cut Lag on both edges of the crossfader.

Units of 0.1 mm can be adjusted from 0.3 mm to 5.5 mm.

- The default Cut Lag is 1.0 mm.
- This Cut Lag setting is a guide, and may not be exact.

[Level Meter] setting

Select the channel level meter or master level meter to show on the level meter in the mixer section.

The default setting is **[Channel Level]**.

- **[Channel Level]**: Channel level meter
- **[Master Level]**: Master level meter

[Microphone Input] setting

- **[Effect Mode]**: Microphone sound can be output from the unit via a PC/Mac. You can apply effects such as the microphone FX in rekordbox for Mac/Windows to the microphone sound.
- **[Low Latency Mode]**: Microphone sound can be output from the unit another way (i.e. not a PC/Mac). You can't apply effects such as the microphone FX in rekordbox for Mac/Windows to the microphone sound, but the time lag due to the transmission delay (latency) of the sound data can be reduced compared to Effect mode.

rekordbox for Mac/Windows

[Talkover Mode] setting

Change Talkover mode.

- **[Advanced]:** Only the mid-range sound, other than the microphone channel, is attenuated according to the set value of the Talkover level.

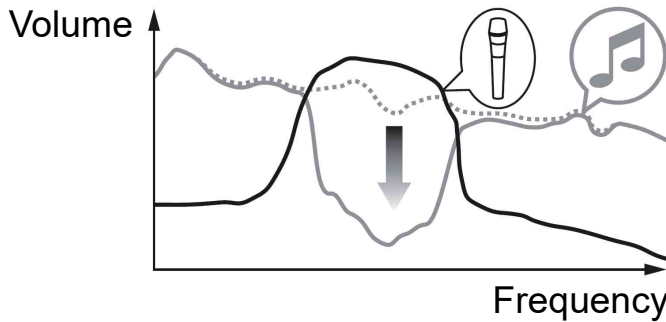

- **[Normal]:** Sound, other than the microphone channel, is attenuated according to the set value of the Talkover level.

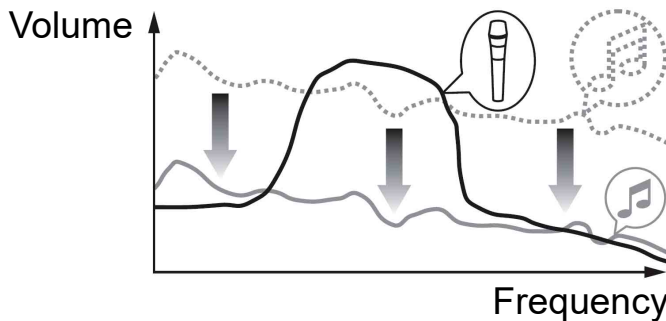

[Talkover Level] setting

Set the audio attenuation level of Talkover mode.

Setting values: -6 dB / -12 dB / -18 dB / -24 dB

[SMART FADER] setting

Select the fader to be used for Smart Fader.

- **[CROSSFADER and Channel Fader]**: Smart Fader turns on when you move the crossfader or a channel fader.
- **[CROSSFADER]**: Smart Fader turns on when you move the crossfader.
- **[Channel Fader]**: Smart Fader turns on when you move a channel fader.

When **[Use the recommended SMART FADER curve]** is set, the curve changes to the recommendation for Smart Fader.

When **[Use the recommended SMART FADER curve]** isn't set, the curve changes according to the setting of **[CROSSFADER Curve]** or **[Channel Fader Curve]** in **[Preferences] > [Controller] > [Mixer]**.

[Controller] > [Effect] tab:

[SMART CFX] setting

Change the position of the SMART CFX preset window from **[Top Left]**, **[Top Right]**, **[Center]**, **[Bottom Left]**, and **[Bottom Right]**.

The default setting is **[Center]**.

[Controller] > [DDJ-FLX4] tab:

[Master output] > [Monaural/Stereo Selection] setting

Change whether mono or stereo sound is output from the **[MASTER]** output terminal.

- **[Monaural]**: Outputs in mono.
- **[Stereo]**: Outputs in stereo.

[Master output] > [Peak Limiter] setting

Prevent sudden and unpleasant digital clipping of audio output from the **[MASTER]** output terminal.

- **[Enable]**: The peak limiter of the master output is enabled.
- **[Disable]**: The peak limiter of the master output is disabled.

Serato DJ Lite

Installing Serato DJ Lite

❖ Installing (Mac)

Do not connect the unit to your Mac until installation is complete.

- Close all programs on your Mac.

- 1 Unzip the downloaded Serato DJ Lite software file.
- 2 Double-click the unzipped software file to launch the installer.
- 3 Read the terms of the License Agreement carefully and if you agree, click **[Agree]**.

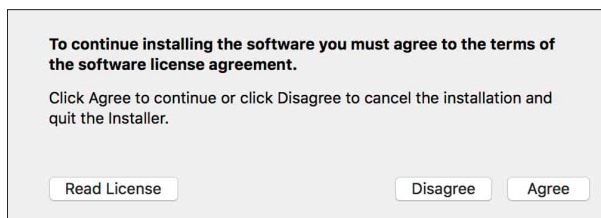

- If you don't agree to the contents of the License Agreement, click **[Disagree]** to cancel the installation.
- 4 Click **[Install]**.
 - 5 Follow the on-screen instructions to install the software.

6 Click **[Close]** to quit the installer.

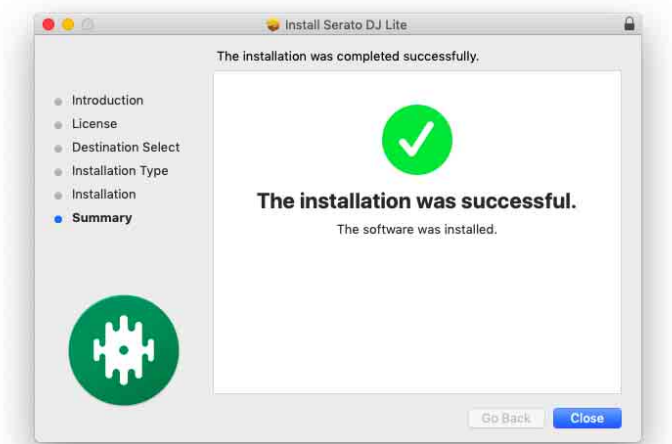

❖ Installing (Windows)

Do not connect the unit to your PC until installation is complete.

- Log into your PC as an administrator before starting the installation.
- Close all programs on your PC.

- 1 Unzip the downloaded Serato DJ Lite software file.
- 2 Double-click the unzipped software file to launch the installer.
- 3 Read the terms of the License Agreement carefully and if you agree, select **[I agree to the license terms and conditions]**, then click **[Install]**.
 - If you don't agree to the contents of the License Agreement, click **[Close]** to cancel the installation.



A message indicating successful installation appears when installation is complete.

- 4 Click **[Close]** to quit the Serato DJ Lite installer.



Basic use

Starting Serato DJ Lite

This manual mainly focuses on explaining the hardware functions of the unit. For detailed instructions on using the Serato DJ Lite software, see the Serato DJ Lite software manual.

For Mac

In Finder, open the **[Applications]** folder, then double-click the **[Serato DJ Lite]** icon.

For Windows 11

In the **[Start]** menu, open the **[All apps]** screen, then click the **[Serato DJ Lite]** icon under **[Serato]**.

For Windows 10

From the **[Start]** menu, click **[Serato] > [Serato DJ Lite]** icon.

The following screen shows after Serato DJ Lite starts.

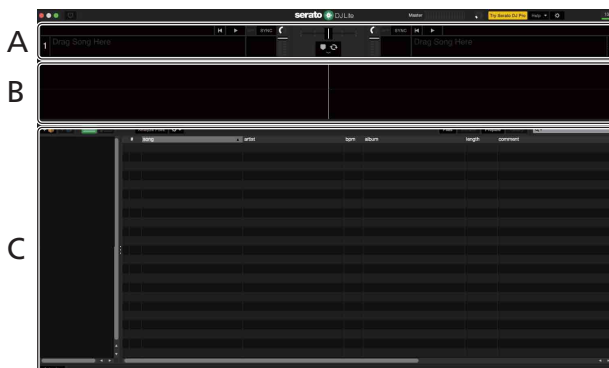

The following screen shows when tracks are loaded onto decks in Serato DJ Lite.



A Deck section

Track information (track name, artist name, BPM, etc.), the overall waveform, and other information about the loaded track is displayed.

B Waveform display

The waveform of the loaded track is displayed.

C Browse section

Tracks in the library, or crates containing multiple tracks, are displayed.

Importing music files (tracks)

- There are various ways to import tracks into Serato DJ Lite. For details, see the Serato DJ Lite software manual.
- If you've previously used Serato Limited's DJ software (e.g. Scratch Live, ITCH, Serato DJ Intro, Serato DJ, or Serato DJ Pro) and you've already created track libraries, you can use these libraries with Serato DJ Lite.
- If you've previously used Serato DJ Intro and you've already created track libraries, you may need to reanalyze tracks to use them with Serato DJ Lite.

The typical way to import music files (tracks) is as follows.

- 1 Click the **[Files]** button in the Serato DJ Lite screen to open the **[Files]** panel.
The contents of your PC/Mac or the hard drive/device connected to the PC/Mac are displayed in the **[Files]** panel.
- 2 Click the folder containing the tracks you want to add to your library.
- 3 Drag and drop the selected folder to the crates panel.
A crate is created and the tracks are added to your library.

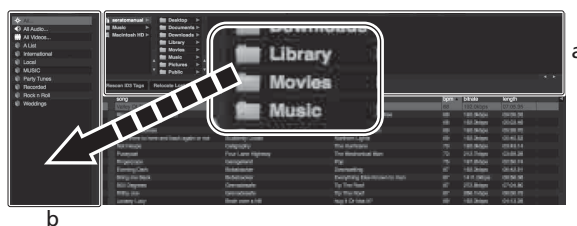

a **[Files]** panel

b Crates panel

Loading an audio track onto a deck

The following explains how to load a track onto deck 1 as an example.

Turn the rotary selector to select a track from the library, then press the **[LOAD]** button for deck 1 (left).

The track is loaded onto the deck.

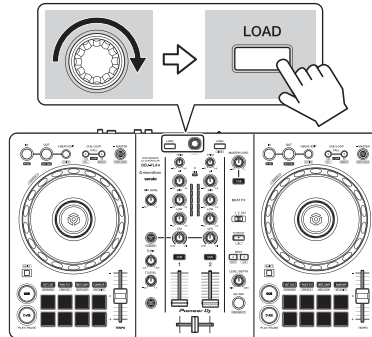

Playing a track

This section explains how to play sound from deck 1 (left) as an example.

- 1 Set the positions of the knobs etc. as shown below.
 - **[TRIM]** knob: turned fully counterclockwise
 - EQ **[HI/MID/LOW]** knobs: center position (12 o'clock)
 - **[CFX]** knob: center position
 - Channel fader: bottom position
 - **[MASTER LEVEL]** knob: turned fully counterclockwise
 - Crossfader: center position
- 2 Press the **[PLAY/PAUSE ▶/III]** button to play the track.

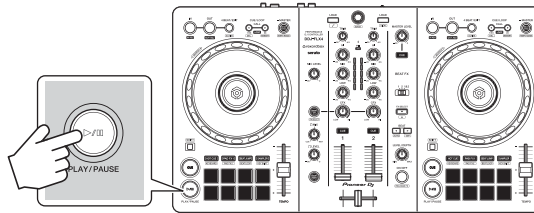

- 3 Turn the **[TRIM]** knob.

Adjust the **[TRIM]** knob so the channel level indicator lights up orange at the loudest part of the track.

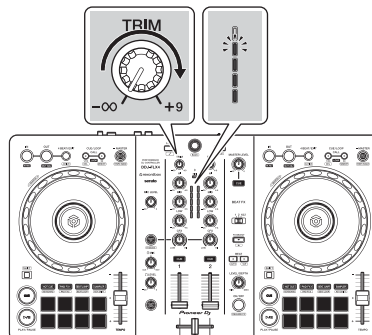

4 Move the channel fader to the top.

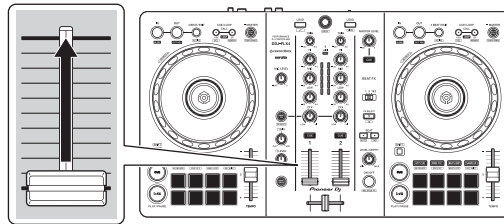

5 Turn the **[MASTER LEVEL]** knob to adjust the volume of the speakers to a level you're happy with.

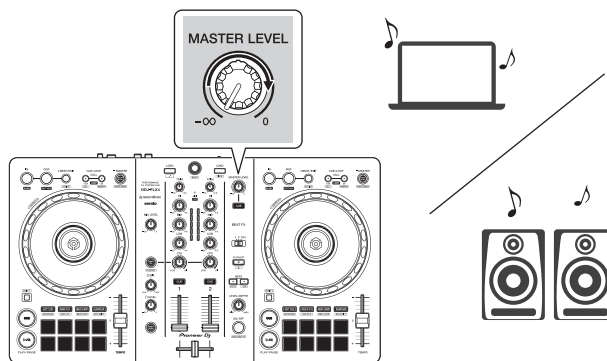

- If you can't output sound from the **[MASTER]** output terminals or the unit isn't recognized by your PC/Mac, refer to the **[FAQ]** on the Pioneer DJ support website.

pioneerdj.com/support/

Monitoring with headphones

This section explains how to play sound from deck 1 (left) as an example.

- 1 Set the positions of knobs etc. as shown below.
 - **[HEADPHONES MIX]** knob: Center
 - **[HEADPHONES LEVEL]** knob: Turned fully counterclockwise
- 2 Press the headphones **[CUE]** button for channel 1.
- 3 Turn the **[HEADPHONES LEVEL]** knob.
Adjust the headphones volume to a level you're happy with.

Quitting Serato DJ Lite

Click the **[x]** button.

Turning off the unit

Disconnect the USB cable to turn off the unit.

Advanced use

Using 4 Beat Loop

While a track is playing, press the **[4 BEAT/EXIT]** button.

Loop playback starts with 4 beats from the point where you press the button.

❖ Canceling loop playback

Press the **[4 BEAT/EXIT]** button.

When the loop out point is reached, the rest of the track continues to play without returning to the loop in point.

Using Manual Loop

You can use Manual Loop to choose the section you want to loop in a track.

- 1 During playback, press the **[IN]** button at the point you want to start looping (the loop in point).
- 2 Press the Loop **[OUT]** button at the point you want the loop to end (the loop out point).
Loop playback starts.

❖ Cutting the loop

Press the **[CUE/LOOP CALL ◀]** button during loop playback.

Each time you press the button, the loop cuts in half.

- You can cut the loop length in half even during 4 Beat Loop playback.

❖ Extending the loop

Press the **[CUE/LOOP CALL▶]** button during loop playback. Each time you press the button, the loop doubles in length.

- You can double the loop length even during 4 Beat Loop playback.

❖ Canceling a loop

Press the **[4 BEAT/EXIT]** button.

The rest of the track continues to play without returning to the loop in point.

Using the Performance Pads

This section mainly relates to Serato DJ Lite. Functions in Serato DJ Pro are shown with **Serato DJ Pro**.

You can switch functions using the buttons for respective Pad modes: **[HOT CUE]**, **[PAD FX1]**, **[BEAT JUMP]**, and **[SAMPLER]**.

❖ Using Hot Cues

You can start playback instantly from the position where a Hot Cue is set.

- Up to 4 Hot Cues can be set and saved for each track in Serato DJ Lite.

1 Press the **[HOT CUE]** mode button.

The unit enters Hot Cue mode.

2 When the track is playing or paused, press a Performance Pad to set a Hot Cue.

The pad's settings are as shown below.

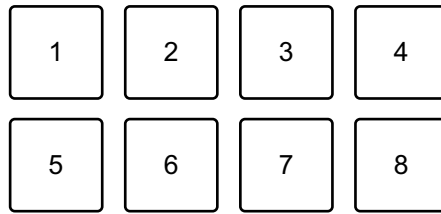

1: Hot Cue A, 2: Hot Cue B, 3: Hot Cue C, 4: Hot Cue D,
5: Previous track, 6: Search ◀◀, 7: Search ▶▶, 8: Censor

Serato DJ Pro

1: Hot Cue A, 2: Hot Cue B, 3: Hot Cue C, 4: Hot Cue D,
5: Hot Cue E, 6: Hot Cue F, 7: Hot Cue G, 8: Hot Cue H

- Censor: Hold down the Performance Pad 8 to play the track in reverse direction. Normal playback resumes when the pad is released.

3 Press a Performance Pad you've set a Hot Cue for.

Playback starts from the Hot Cue point.

- You can clear Hot Cues by pressing a Performance Pad while holding the **[SHIFT]** button.

❖ Using Pad FX

You can add a wide range of effects to your performances simply by pressing and releasing the Performance Pads.

1 Press the **[PAD FX1]** mode button.

The unit enters Pad FX mode.

2 Press and hold down a Performance Pad.

The effect set on the Performance Pad turns on.

The pad's settings are as shown below.

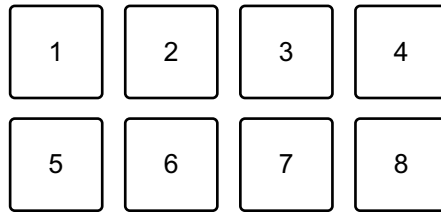

1: Effect A, 2: Effect B, 3: Effect C, 4: Effect D,
5: Previous track, 6: Search ◀◀, 7: Search ▶▶, 8: Censor

Serato DJ Pro

1: Effect A, 2: Effect B, 3: Effect C, 4: Effect D,
5: Effect E, 6: Effect F, 7: Effect G, 8: Effect H

3 Release the Performance Pad.

The effect turns off.

❖ Using Beat Jump

You can use Beat Jump to move the playback position by different numbers of beats.

1 Press the **[BEAT JUMP]** mode button.

The unit enters Beat Jump mode.

2 Press a Performance Pad when the track is playing or paused.

The pad's settings are as shown below.

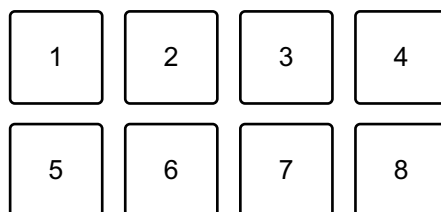

1: Beat Jump to the left, 2: Halve the Beat Jump length,
3: Double the Beat Jump length, 4: Beat Jump to the right,
5: Previous track, 6: Search ◀◀, 7: Search ▶▶, 8: Censor

❖ Using Sampler

You can use the Performance Pads to play tracks or sounds assigned to the Sampler slots.

- 1 Open the **[SAMPLER]** panel in Serato DJ Lite.
- 2 Press the **[SAMPLER]** mode button on the unit.
The unit enters Sampler mode.
- 3 Drag and drop tracks or sounds from the library to load them into the **[SAMPLER]** slots.
The sampler settings and loaded tracks are saved.
- 4 Press a Performance Pad.
The track or sound assigned to the relevant slot is played.
The pad's settings are as shown below.

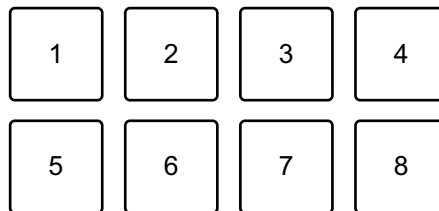

1: Slot 1, 2: Slot 2, 3: Slot 3, 4: Slot 4,
5: Previous track, 6: Search ◀◀, 7: Search ▶▶, 8: Censor

Serato DJ Pro

1: Slot 1, 2: Slot 2, 3: Slot 3, 4: Slot 4,
5: Slot 5, 6: Slot 6, 7: Slot 7, 8: Slot 8

- When you press a Performance Pad while holding the **[SHIFT]** button, the sound assigned to the slot that is currently playing stops.

❖ Using Pitch Play

Serato DJ Pro

Pitch Play is a function of the Pitch 'n Time DJ expansion pack.

- To use Pitch 'n Time DJ, you'll need to activate it first.

For details, visit the website below.

serato.com/activation/pitch-n-time

- 1 Press the **[HOT CUE]** mode button while holding the **[SHIFT]** button.

The unit enters Pitch Play mode.

- 2 Press a Performance Pad while holding the **[SHIFT]** button.

The Hot Cue point set on the Performance Pad is selected.

- 3 Press a Performance Pad.

Playback starts from the selected Hot Cue point with the pitch set to the Performance Pad as follows.

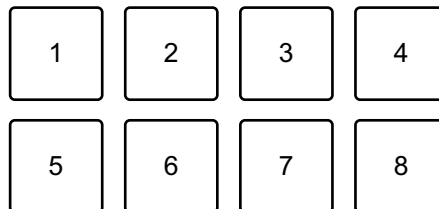

1: ± 0 Semitones, 2: +1 Semitone, 3: +2 Semitones, 4: +3 Semitones,
5: -4 Semitones, 6: -3 Semitones, 7: -2 Semitones, 8: -1 Semitone

❖ Using Roll

If you press a Performance Pad when the unit is in Roll mode, a loop with the number of beats assigned to the pad is set and the loop plays until you release the pad.

During Loop Roll playback, normal playback with the original rhythm continues in the background (but you can only hear the Loop Roll).

When you cancel Loop Roll, playback resumes from the position reached in the background.

1 Press the **[PAD FX1]** mode button while holding the **[SHIFT]** button. The unit enters Roll mode.

2 Press and hold down a Performance Pad.

Loop Roll playback starts with the number of beats in the settings assigned to that pad.

Playback continues in the background during Loop Roll playback (but you can only hear the Loop Roll).

- Press the **[CUE/LOOP CALL ◀]** or **[CUE/LOOP CALL ▶]** button during Loop Roll to change the number of beats for the Loop Roll that's currently playing.

The pad's settings are as shown below.

1	2	3	4
5	6	7	8

1: 1/4 beat, 2: 1/2 beat, 3: 1 beat, 4: 2 beats,

5: Previous track, 6: Search ◀◀, 7: Search ▶▶, 8: Censor

Serato DJ Pro

1: 1/32 beat, 2: 1/16 beat, 3: 1/8 beat, 4: 1/4 beat,

5: 1/2 beat, 6: 1 beat, 7: 2 beats, 8: 4 beats

3 Release the Performance Pad.

Loop Roll is canceled, and playback resumes from the position reached in the background.

❖ Using Auto Loop

When you press a Performance Pad in Auto Loop mode, a loop with the number of beats assigned to the pad is set and the loop plays until you release the pad.

1 Press the **[BEAT JUMP]** mode button while holding the **[SHIFT]** button.

The unit enters Auto Loop mode.

2 Press a Performance Pad during playback.

Loop playback starts with the number of beats in the setting assigned to that pad.

- When you press the same Performance Pad again, loop playback is canceled.

The pad's settings are as shown below.

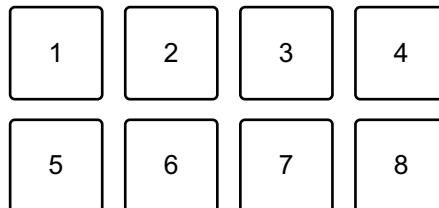

1: 1 beat, 2: 2 beats, 3: 4 beats, 4: 8 beats, 5: Previous track, 6: Search ◀◀, 7: Search ▶▶, 8: Censor

Serato DJ Pro

1: 1/8 beat, 2: 1/4 beat, 3: 1/2 beat, 4: 1 beat, 5: 2 beats, 6: 4 beats, 7: 8 beats, 8: 16 beats

❖ Using Key Shift

Serato DJ Pro

Key Shift is a function of the Pitch 'n Time DJ expansion pack.

- To use Pitch 'n Time DJ, you'll need to activate it first.

For details, visit the website below.

serato.com/activation/pitch-n-time

When you press a Performance Pad in Key Shift mode, the key of the track that's currently playing is changed to the pitch set to the pressed pad.

- 1 Press the **[SAMPLER]** mode button while holding the **[SHIFT]** button.

The unit enters Key Shift mode.

The pad's settings are as shown below.

1	2	3	4
5	6	7	8

1: ± 0 Semitones, 2: +1 Semitone, 3: +2 Semitones, 4: +3 Semitones,
5: -4 Semitones, 6: -3 Semitones, 7: -2 Semitones, 8: -1 Semitone

A semitone is a unit used to determine the pitch of a sound. +1 semitone means the sound is higher in pitch than the original sound by half.

- 2 Press a Performance Pad.

The track's key is changed to the pitch assigned to the pad.

Using Fader Start

❖ Using Channel Fader Start

1 Set the temporary cue point.

Pause the track at the position you want to start playback from, then press the **[CUE]** button on that deck.

2 While holding the **[SHIFT]** button, move the channel fader from the bottom to the top.

Playback starts from the temporary cue point.

- If you move the channel fader back to the bottom while holding the **[SHIFT]** button during playback, the track instantly jumps back to the temporary cue point and playback pauses (Back Cue).

When no temporary cue point is set, playback starts from the beginning of the track.

❖ Using Crossfader Start

1 Set the temporary cue point.

Pause the track at the position you want to start playback from, then press the **[CUE]** button on that deck.

2 Move the crossfader all the way to the left or right side.

If you want to use Crossfader Start to trigger playback on channel 2, set the crossfader to the left side, and vice versa.

3 While holding the **[SHIFT]** button, move the crossfader towards the opposite side from where it's set.

Playback starts from the temporary cue point.

- If you move the crossfader back while holding the **[SHIFT]** button during playback, the playback position instantly jumps back to the temporary cue point and pauses (Back Cue).

When no temporary cue point is set, playback starts from the beginning of the track.

Analyzing tracks

Click the **[Analyze Files]** button in Serato DJ Lite to analyze tracks in your library that haven't been analyzed yet. You can also analyze the track by dragging and dropping it on the **[Analyze Files]** button.

- If a track is loaded to a deck before analysis is complete, it may take some time to display its BPM and waveform.
- Depending on the number of tracks, analysis may take some time.

Using effects

Serato DJ Lite has 2 types of effects: FX1 and FX2.

The following screen shows effect units in Serato DJ Lite.

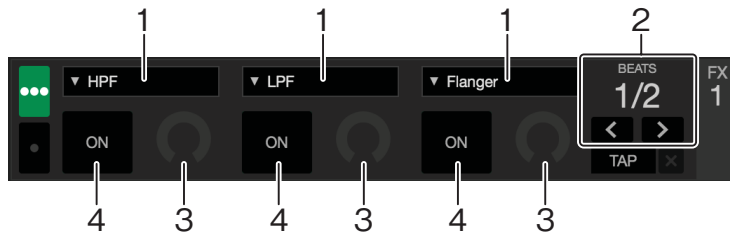

1: Type of effect, 2: Beats of effect, 3: Effect level, 4: Effect ON/OFF

❖ Using an effect

The following explains how to operate the slot 1 effect for FX1 on the Serato DJ Lite screen.

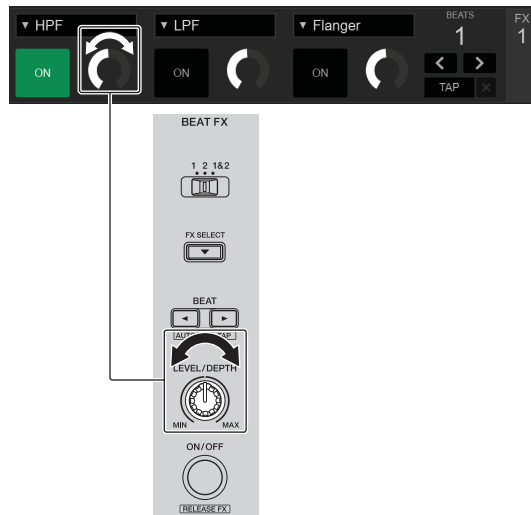

- 1 Display the **[FX]** panel on the Serato DJ Lite screen.
- 2 Press the **[FX SELECT]** button.
The effect changes each time you press the button.
- 3 Slide the **[FX CH SELECT]** switch.
 - **[1]**: Applies the effect to the sound of channel 1.
 - **[2]**: Applies the effect to the sound of channel 2.
 - **[1&2]**: Applies the effect to the sound of channel 1 and channel 2.
- 4 Press the **[BEAT ◀]** button or **[BEAT ▶]** button.
Set the number of beats synchronized to the effect sound.
- 5 Turn the **[FX LEVEL/DEPTH]** knob to adjust the parameter of the effect.
The parameter on slot 1 of FX1 on the Serato DJ Lite screen is applied.
- 6 Press the **[FX ON/OFF]** button.
The effect is applied to the sound of the channel you set in step 3.

You can adjust the parameter of the effect by turning the **[FX LEVEL/DEPTH]** knob.

When the effect is turned on, the **[FX ON/OFF]** button flashes.

- Press the **[FX ON/OFF]** button again to turn off the effect.

Using Smart CFX

Using the **[CFX]** knob, you can add a dynamic effect to liven up the track.

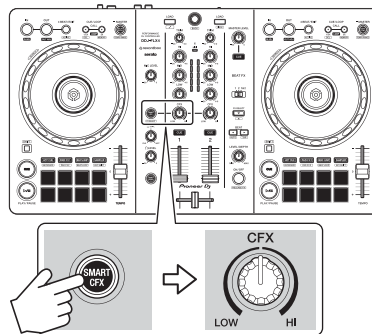

1 Press the **[SMART CFX]** button.

The Smart CFX preset 1 (Echo type) is turned on.

- If you press the **[SMART CFX]** button while holding the **[SHIFT]** button, the Smart CFX preset 2 (Reverb type) is turned on.

2 Turn the **[CFX]** knob.

The effect is applied to the track that's playing.

Turn the **[CFX]** knob to change the effect sound.

- When the knob is at the center position, the effect isn't applied.

3 Press the **[SMART CFX]** button again.

Smart CFX turns off.

Using Smart Fader

With Smart Fader, you can use the crossfader or channel faders to create an exciting transition as you mix from one track to the next.

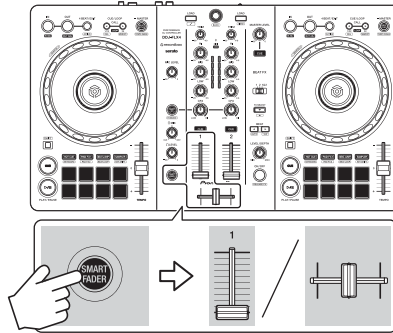

- 1 Press the **[SMART FADER]** button.
The Smart Fader preset 1 (Echo type) is turned on.
 - If you press the **[SMART FADER]** button while holding the **[SHIFT]** button, the Smart Fader preset 2 (Reverb type) is turned on.
- 2 Slide the channel faders and crossfader.
The effect is automatically applied according to the fader operation.
- 3 Press the **[SMART FADER]** button again.
Smart Fader turns off.

Using a microphone

- 1 Connect a microphone to the **[MIC]** input terminal.
- 2 Turn the **[MIC LEVEL]** knob.
Adjust the volume of the sound output from the **[MIC]** channel.
 - The sound comes out at a high volume if the knob is turned all the way to the right.
- 3 Talk into the microphone.
 - You can't add effects to the microphone sound on this unit.

Changing the crossfader assign

You can select **[Reverse]** or **[Disable]** on the Serato DJ Lite screen to change the way the crossfader works.

- 1 Click  in Serato DJ Lite.
- 2 Click the **[Mixer]** tab.
 - **[Reverse]**: Reverses the crossfader assign.
 - **[Disable]**: Deactivates the crossfader and allows sound from any channel to pass through.

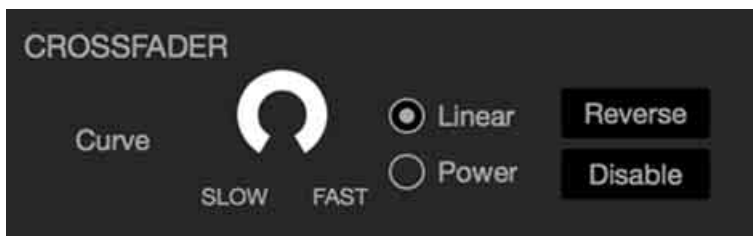

Setting the crossfader curve

You can set the crossfader curve on the Serato DJ Lite screen.

- 1 Click  in Serato DJ Lite.
- 2 Click the **[Mixer]** tab.
- 3 Adjust the crossfader curve.
 - The more you turn it toward **[SLOW]**, the more gradual the rise of the curve.
 - The more you turn it toward **[FAST]**, the sharper the rise of the curve.

rekordbox for iOS/Android

Installing rekordbox for iOS/Android

Getting started with rekordbox for iOS/Android

If you're using rekordbox for iOS/Android for the first time, install the latest version.

If you already have rekordbox for iOS/Android installed, update to the latest version using App Store or Google Play.

- You are responsible for preparing your mobile device and other elements.

Installing rekordbox for iOS/Android

Procedures may differ depending on the operating system (OS) of your mobile device.

❖ Installing (iOS/iPadOS)

- 1 Scan the QR code or visit the URL below to open the App Store.



<https://apps.apple.com/app/id1487048203>

rekordbox for iOS/Android

2 Install rekordbox for iOS.

When installation is finished, tap **[Open]** to start rekordbox for iOS.

❖ Installing (Android)

1 Scan the QR code or visit the URL below to open Google Play.



<https://play.google.com/store/apps/details?id=com.pioneerdj.rekordbox>

2 Install rekordbox for Android.

When installation is finished, tap **[Open]** to start rekordbox for Android.

Basic use

Starting rekordbox for iOS/Android

Tap the rekordbox icon.



rekordbox

rekordbox will ask for permission to access your mobile library (including music). Tap **[OK]**.

Read the terms of the license agreement carefully and if you agree to them, check **[I have read the above software use, license agreement]**, then tap **[Agree]**.

Connecting your mobile device to the unit

❖ Connecting with a USB cable

- 1 Connect your USB power adapter or mobile battery to the unit's USB port (for power supply) using a USB cable to turn the unit on.
- 2 Connect your mobile device to the unit's USB port (for device connection) using a USB cable.

rekordbox for iOS/Android

❖ Connecting via Bluetooth

- 1 Connect your USB power adapter or mobile battery to the unit's USB port (for power supply) using a USB cable to turn the unit on.
- 2 Start rekordbox for iOS/Android and turn your mobile device screen horizontal to close the browse screen. The screen in step 3 is displayed.
- 3 Tap  at the top-center of the screen.



- 4 Tap .

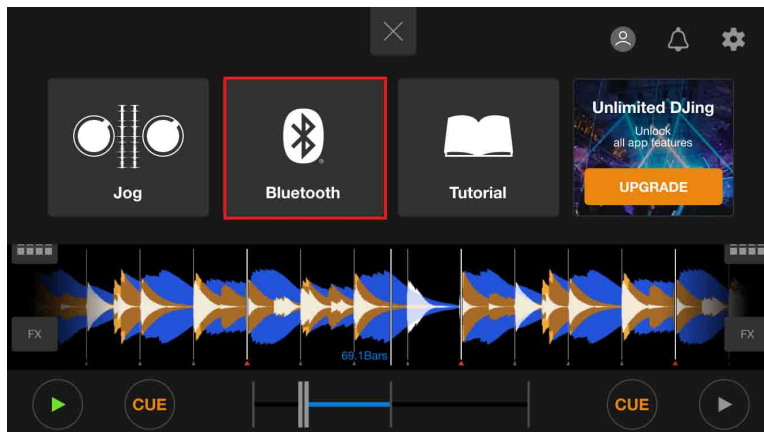

5 Tap [DDJ-FLX4].

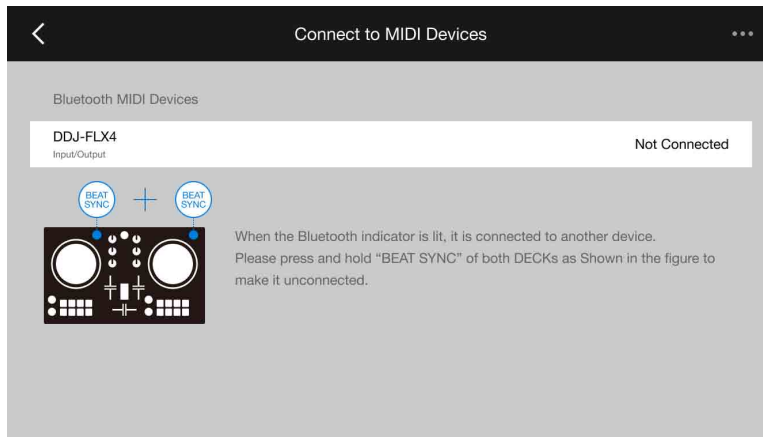

When connection is complete, the following screen appears.

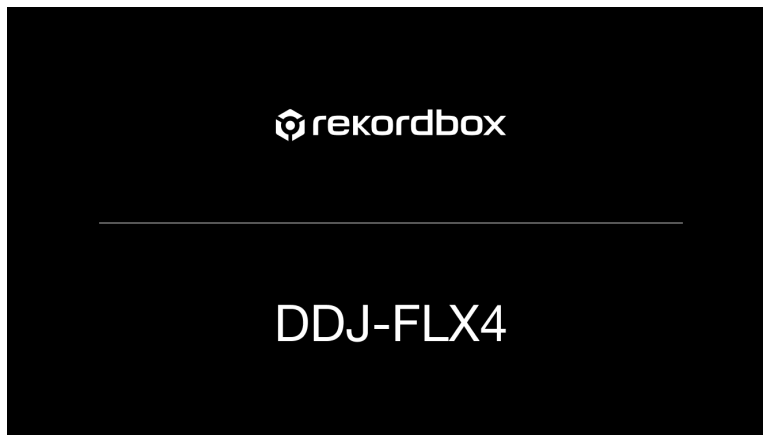

Loading an audio track onto a deck

The following explains how to load a track onto deck 1 as an example.

- 1 Turn the rotary selector to select a track.

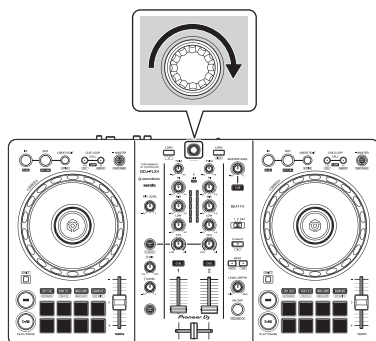

- Press the rotary selector to move the cursor to the next level down.

Cursor on the upper level

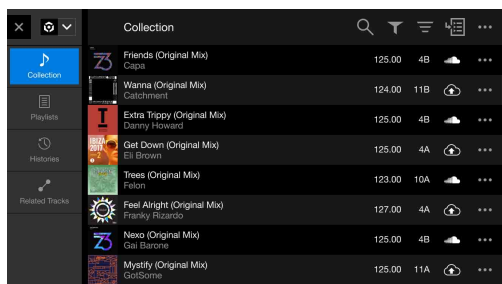

Cursor on the lower level

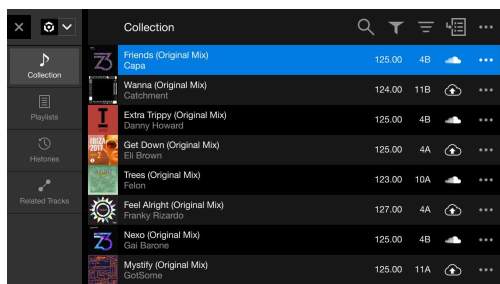

- Press the rotary selector while holding the **[SHIFT]** button to move the cursor to the next level up.

Cursor on the lower level

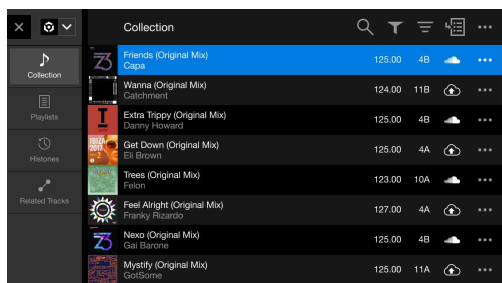

Cursor on the upper level



rekordbox for iOS/Android

- 2 Press the **[LOAD]** button for deck 1 (left).
The track loads onto the deck.

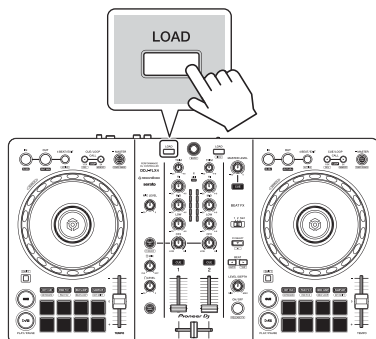

Playing a track

This section explains how to play sound from deck 1 (left) as an example.

- 1 Set the positions of the knobs etc. as follows:
 - **[TRIM]** knob: turned fully counterclockwise
 - EQ **[HI/MID/LOW]** knobs: center position (12 o'clock)
 - **[CFX]** knob: center position
 - Channel fader: bottom position
 - **[MASTER LEVEL]** knob: turned fully counterclockwise
 - Crossfader: center position
- 2 Press the **[PLAY/PAUSE ▶/III]** button to play the track.

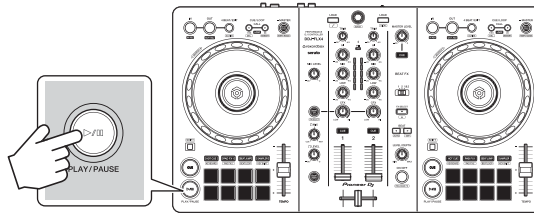

- 3 Turn the **[TRIM]** knob.
Adjust the **[TRIM]** knob so the channel level indicator lights up orange at the loudest part of the track.

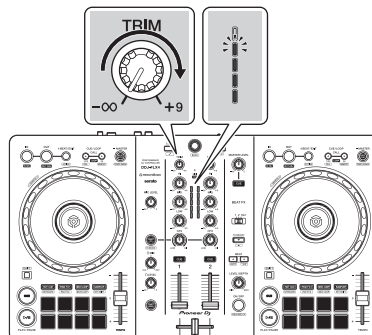

4 Move the channel fader to the top.

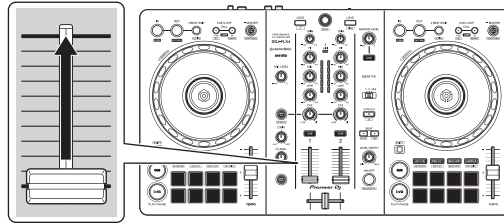

5 Adjust the volume of the speakers to a level you're happy with.

When using a USB connection: Turn the **[MASTER LEVEL]** knob to adjust the volume of sound from the **[MASTER]** output terminal.

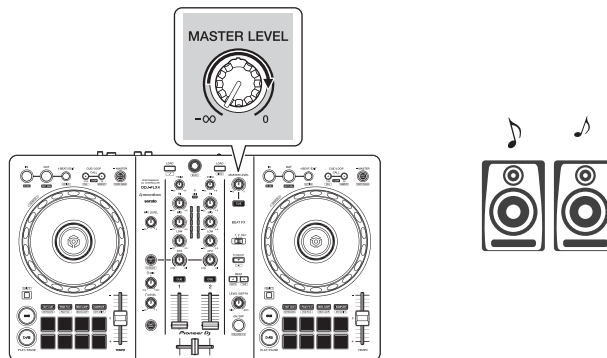

- If you can't output sound from the **[MASTER]** output terminals or the unit isn't recognized by your mobile device, see: Troubleshooting (page 150).

When using a Bluetooth connection: Sound outputs from your mobile device.

- Adjust the volume of the speakers of the mobile device, or speakers connected to your mobile device, instead of using the **[MASTER LEVEL]** knob.

Monitoring with headphones when using a USB connection

When your mobile device is connected to the unit with a USB cable, you can monitor with headphones from the headphones output terminal on the unit.

This section explains how to play sound from deck 1 (left) as an example.

- 1 Connect your headphones to the headphones output terminal on the unit.
- 2 Set the positions of knobs etc. as shown below.
 - **[HEADPHONES MIX]** knob: Center
 - **[HEADPHONES LEVEL]** knob: Turned fully counterclockwise
- 3 Press the headphones **[CUE]** button for channel 1.
- 4 Turn the **[HEADPHONES LEVEL]** knob.
Adjust the headphones volume to a level you're happy with.

Monitoring with headphones when using a Bluetooth connection

This section explains how to play sound from deck 1 (left) as an example.

- 1 Connect a split cable (not supplied) to your mobile device.
The split cable is for splitting sound from the stereo headphones jack to the left and right channels.
- 2 Connect the speaker to the left channel of the split cable and headphones to the right channel.
The **[MASTER]** output terminal and headphones output terminal on the unit can't be used.

rekordbox for iOS/Android

- 3 Start rekordbox for iOS/Android and turn your mobile device screen horizontal to close the browse screen.
The screen in step 4 is displayed.

- 4 Tap  at the top-center of the screen.



- 5 Tap  to open the [Settings] screen.

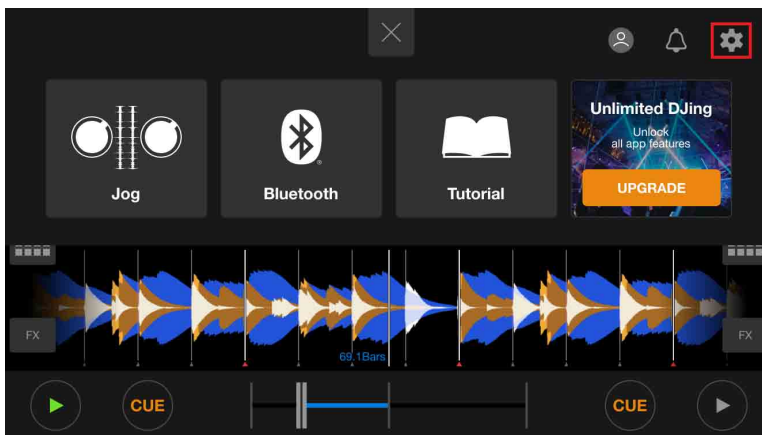

6 Tap **[Audio]** > **[PRE-CUEING]** > **[Split Output]** to turn it on.

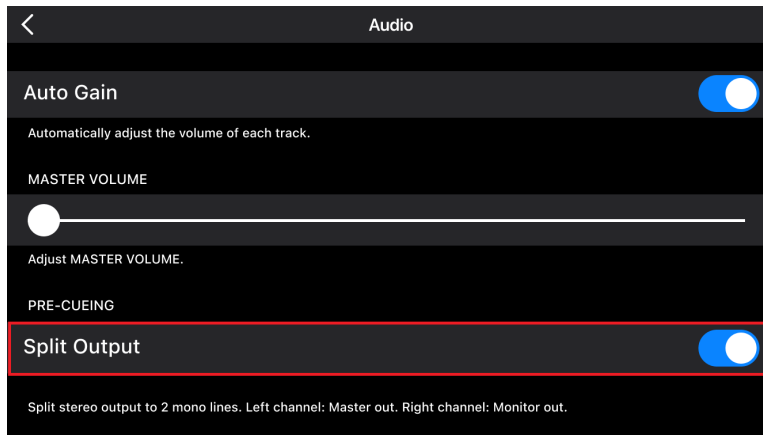

7 Press the headphones **[CUE]** button of channel 1 on the unit.

8 Tap **[Audio]** > **[PRE-CUEING]** to adjust the volume.

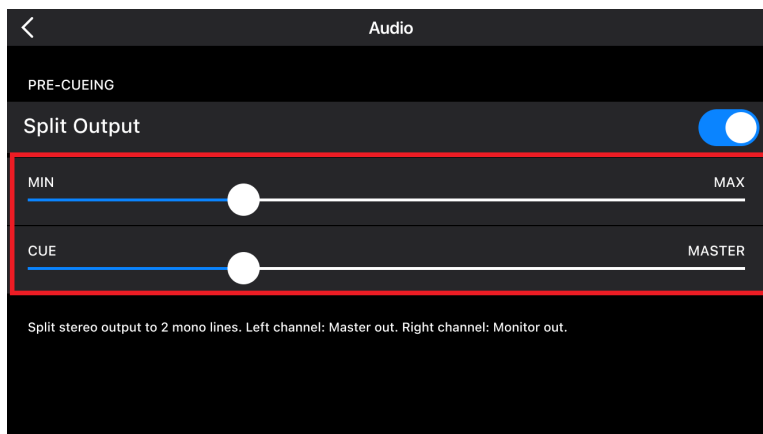

If stereo sound doesn't output correctly

If your Android device is connected with a USB cable, it may not connect correctly and the stereo sound may not output normally. In this case, set **[Android MONO/STEREO]** to **[MONO]** on the rear panel.

Turning off the unit

Disconnect the USB cable to turn off the unit.

Advanced use

Using 4 Beat Loop

While a track is playing, press the **[4 BEAT/EXIT]** button.

Loop playback starts with 4 beats from the point where you press the button.

- When the Quantize function is turned on, you might notice a slight delay as the loop synchronizes to the beat.

❖ Canceling loop playback

Press the **[4 BEAT/EXIT]** button.

When the loop out point is reached, the rest of the track continues to play without returning to the loop in point.

Using Manual Loop

You can use Manual Loop to choose the section you want to loop in a track.

- When the Quantize function is turned on, you might notice a slight delay as the loop synchronizes to the beat.
- 1 During playback, press the **[IN]** button at the point you want to start looping (the loop in point).
 - 2 Press the **[OUT]** button at the point you want the loop to end (the loop out point).
Loop playback starts.

❖ Cutting the loop

Press the **[CUE/LOOP CALL ◀]** button.

Each time you press the button, the loop cuts in half.

- You can cut the loop length in half even during 4 Beat Loop playback.

❖ Extending the loop

Press the **[CUE/LOOP CALL ▶]** button.

Each time you press the button, the loop doubles in length.

- You can double the loop length even during 4 Beat Loop playback.

❖ Canceling a loop

Press the **[4 BEAT/EXIT]** button.

The rest of the track continues to play without returning to the loop in point.

❖ Changing the loop in point

Press the **[IN]** button and turn the jog wheel during loop playback.

The loop in point changes.

❖ Changing the loop out point

Press the **[OUT]** button and turn the jog wheel during loop playback.

The loop out point changes.

Using the Performance Pads

❖ Using Hot Cues

You can start playback instantly from the position where a Hot Cue is set. Loops can also be set and called up instantly.

- Up to 8 Hot Cues can be set and saved for each track in rekordbox for iOS/Android.

Setting and calling up a Hot Cue

- 1 Press the **[HOT CUE]** mode button.

The unit enters Hot Cue mode.

- 2 When the track is playing or paused, press a Performance Pad to set a Hot Cue.

Hot Cues are set to Performance Pads as follows:

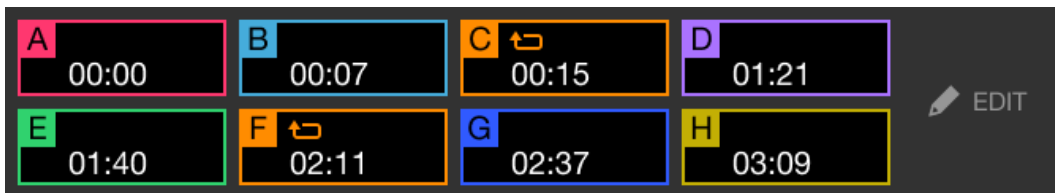

- 3 Press a Performance Pad you've set a Hot Cue for.

Playback starts from the Hot Cue point.

- You can clear Hot Cues by pressing a Performance Pad while holding the **[SHIFT]** button.

Setting and calling up 4 Beat Loop

- 1 Press the **[HOT CUE]** mode button.
The unit enters Hot Cue mode.
- 2 Press and hold the **[4 BEAT/EXIT]** button during playback.
A loop with 4 beats is set at the position where you pressed the button, and loop playback starts.
- 3 Press a Performance Pad to set a loop during loop playback.
- 4 Press the Performance Pad.
Loop playback starts from the loop in point.
 - You can clear the loop by pressing the Performance Pad while holding the **[SHIFT]** button.

Setting and calling up Manual Loop

- 1 Press the **[HOT CUE]** mode button.
The unit enters Hot Cue mode.
- 2 Press the **[IN]** button during playback, and press the **[OUT]** button.
Loop playback starts.
- 3 Press a Performance Pad to set a loop during the loop playback.
- 4 Press the Performance Pad.
Loop playback starts from the loop in point.
 - You can clear the loop by pressing the Performance Pad while holding the **[SHIFT]** button.

❖ Using Pad FX

You can add a wide range of effects to your performances simply by pressing and releasing the Performance Pads.

- 1 Turn on Pad FX mode 1 or Pad FX mode 2.
 - Pad FX mode 1: Press the **[PAD FX1]** mode button.
 - Pad FX mode 2: Press the **[PAD FX1]** mode button while holding the **[SHIFT]** button.

When switching between Pad FX mode 1 and Pad FX mode 2, effects set to the Performance Pads are changed.

Pad FX mode 1

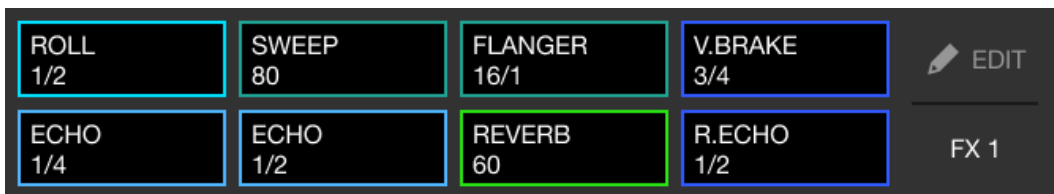

Pad FX mode 2



- 2 Press and hold down a Performance Pad.
The effect turns on. The sound changes according to the type of effect and the number of beats in the settings assigned to that pad.
- 3 Release the Performance Pad.
The effect turns off.

Using Release FX of Pad FX

You need to assign a Release FX to a Performance Pad in advance.

- 1 Press and hold down a Performance Pad that has an effect other than a Release FX assigned to it.
The effect turns on. The sound changes according to the type of effect and the number of beats in the settings assigned to that pad.
- 2 Press the Performance Pad that has a Release FX assigned to it, and release it.
The effect turns off, and the Release FX is added.

❖ Using Beat Jump

You can move the playback position instantly, without breaking the rhythm of the track that's playing.

- 1 Press the **[BEAT JUMP]** mode button.
The unit enters Beat Jump mode.
The number and direction of beats set to the Performance Pads are as follows:

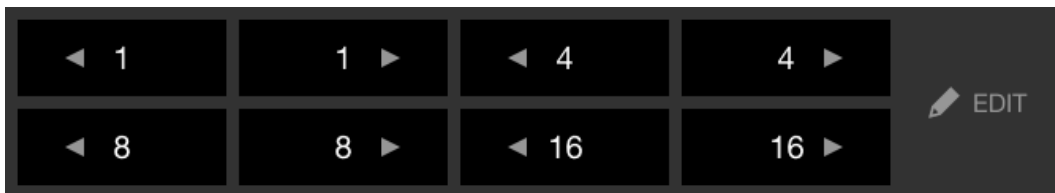

- 2 Press a Performance Pad.
The playback position is moved by the number and direction of beats set on the pad.

❖ Using Sampler

You can use the Performance Pads to play tracks or sounds assigned to the Sampler slots.

- 1 Press the **[SAMPLER]** mode button.
The unit enters Sampler mode.
- 2 Adjust the sampler volume.

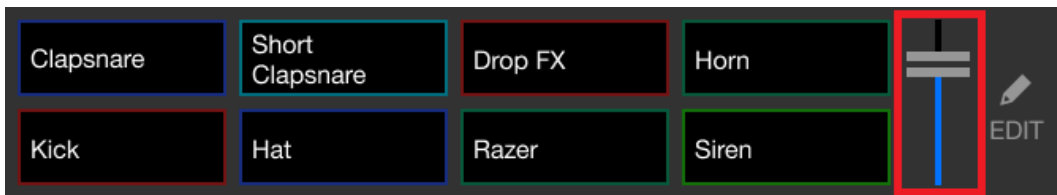

- 3 Press a Performance Pad.
The track or sound assigned to the relevant slot is played.
 - Samplers set to the Performance Pads on deck 1 and deck 2 are different.

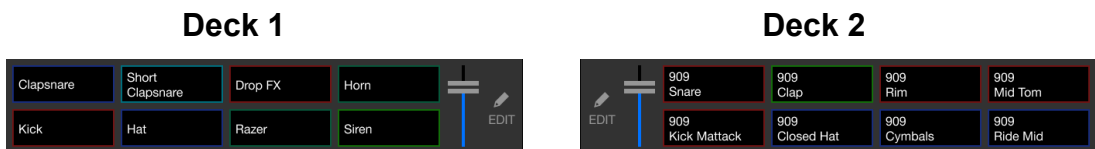

- 4 During Sampler playback, press the Performance Pad again.
The sound plays from the beginning again.
- 5 Press a Performance Pad while holding the **[SHIFT]** button during Sampler playback.
The sound of the slot that is currently playing stops.

❖ Using Keyboard mode

Use Performance Pads to play a Hot Cue in different pitches, as if you're using a keyboard.

- 1 Press the **[HOT CUE]** mode button while holding the **[SHIFT]** button.

The unit enters Keyboard mode.

- 2 Press a Performance Pad.

Select the Hot Cue you want to use with Keyboard mode.

- If no Hot Cue is set, the current playback position is set as a Hot Cue. After selecting the Hot Cue which you set, the Hot Cue is used with Keyboard mode.
- To reselect a Hot Cue, press the **[HOT CUE]** mode button while holding the **[SHIFT]** button.

When the Hot Cue is selected, the various pitches are set to the Performance Pads as follows (Default):

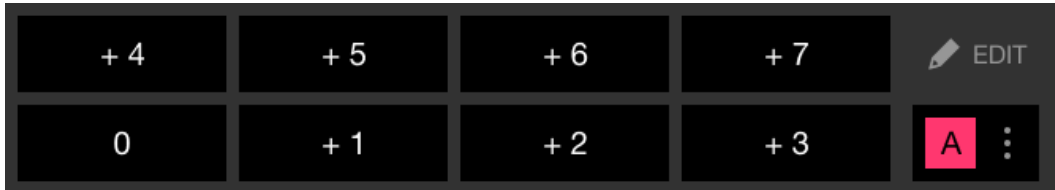

The number displayed on each pad shows the semitones number.

Example) +4: +4 Semitones

A semitone is a unit used to determine the pitch of a sound. +1 semitone means the sound is higher in pitch than the original sound by half.

- 3 Press a Performance Pad.

Playback starts from the Hot Cue point, with the sound pitch assigned to that pad.

- You can clear Hot Cues by pressing a Performance Pad while holding the **[SHIFT]** button.

❖ Using Beat Loop

If you press a Performance Pad, a loop with the number of beats assigned to the pad is set. The loop keeps playing after you remove your finger from the pad.

- 1 Press the **[BEAT JUMP]** mode button while holding the **[SHIFT]** button.

The unit enters Beat Loop mode.

The number of beats set to the Performance Pads are as follows:

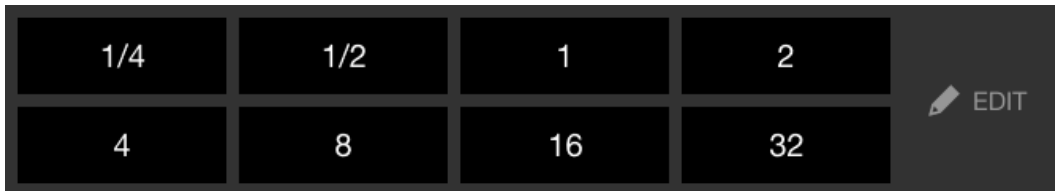

The number displayed on each pad shows the number of beats for Beat Jump.

- 2 Press a Performance Pad.
The loop plays with the number of beats set on that pad.
- 3 Press the same Performance Pad again.
The loop is canceled and the rest of the track continues to play.

❖ Using Key Shift

When you press a Performance Pad in Key Shift mode, the key of the track that's currently playing is changed to the pitch set to the pressed pad.

- 1 Press the **[SAMPLER]** mode button while holding the **[SHIFT]** button.

The unit enters Key Shift mode.

The various pitches are set to the Performance Pads as follows (Default):



The number displayed on each pad shows the semitones number.

Example) +4: +4 Semitones

A semitone is a unit used to determine the pitch of a sound. +1 semitone means the sound is higher in pitch than the original sound by half.

- 2 Press a Performance Pad.

The track's key is changed to the pitch assigned to the pad.

Setting and calling up a cue point or loop point

❖ Setting a cue point or loop point

- 1 Pause the track and move the playback position to where you want to set a cue point or loop point.
- 2 Press the **[CUE]** button while the track is paused.
- 3 Press the **[CUE/LOOP CALL ►]** button while holding the **[SHIFT]** button.
The cue point or loop point is saved.

❖ Calling up the cue point or loop point

Press the **[CUE/LOOP CALL ►]** or **[CUE/LOOP CALL ◀]** button.
The cue point or loop point is called up.

❖ Deleting the cue point or loop point

- 1 Press the **[CUE/LOOP CALL ►]** or **[CUE/LOOP CALL ◀]** button.
The cue point or loop point is called up.
- 2 Press the **[CUE/LOOP CALL ◀]** button while holding the **[SHIFT]** button.
The cue point or loop point is deleted.

Using Fader Start

❖ Using Channel Fader Start

- 1 Set the cue point.

Pause the track at the position you want to start playback from, then press the **[CUE]** button on that deck.

- 2 While holding the **[SHIFT]** button, move the channel fader from the bottom to the top.

Playback starts from the cue point.

- If you move the channel fader back to the bottom while holding the **[SHIFT]** button during playback, the track instantly jumps back to the cue point and playback pauses. (Back Cue)

When no cue point is set, playback starts from the beginning of the track.

❖ Using Crossfader Start

- 1 Set the cue point.

Pause the track at the position you want to start playback from, then press the **[CUE]** button on that deck.

- 2 Move the crossfader all the way to the left or right side.

If you want to use Crossfader Start to trigger playback on channel 2, set the crossfader to the left side, and vice versa.

- 3 While holding the **[SHIFT]** button, move the crossfader towards the opposite side from where it's set.

Playback starts from the cue point.

- If you move the crossfader back while holding the **[SHIFT]** button during playback, the playback position instantly jumps back to the cue point and pauses. (Back Cue)

When no cue point is set, playback starts from the beginning of the track.

Analyzing tracks

Set **[Settings]** > **[In-app player settings]** > **[Track Analysis]** > **[Auto Analysis]** on the vertical screen or **[Settings]** > **[General]** > **[Track Analysis]** > **[Auto Analysis]** on the horizontal screen to start track analysis.

- If a track is loaded to a deck before analysis is complete, it may take some time to display its BPM and waveform.
- Depending on the number of tracks, analysis may take some time.

Using Beat FX

You can apply effects that match the tempo (BPM) of the track loaded on the deck.

- 1 Press the **[BEAT FX SELECT]** button on the unit.
The selected Beat FX changes each time you press the button.
If you press the **[BEAT FX SELECT]** button while holding the **[SHIFT]** button, the selected Beat FX changes in the reverse order.
- 2 Slide the **[BEAT FX CH SELECT]** switch.
The channel that Beat FX will be applied to changes each time you slide the switch.
 - **[1]**: Applies Beat FX to the sound of channel 1.
 - **[2]**: Applies Beat FX to the sound of channel 2.
 - **[1&2]**: Applies Beat FX to the sound of channel 1 and channel 2.
For **[1&2]**, the beat, effect type, etc. are synchronized between the unit 1 and unit 2 of Beat FX. The beat settings may not be synchronized due to differences in the BPM of the tracks loaded on the decks.
- 3 Press the **[BEAT ◀]** or **[BEAT ▶]** button.
Set the number of beats (or parameters) synchronized to the effect sound.

4 Press the **[BEAT FX ON/OFF]** button.

The Beat FX is applied to the sound of the channel you set in step 2.

You can adjust the parameter of Beat FX by turning the **[BEAT FX LEVEL/DEPTH]** knob.

When Beat FX is turned on, the button flashes.

- Press the **[BEAT FX ON/OFF]** button again to turn off Beat FX.

5 Press the **[BEAT FX ON/OFF]** button and release it while holding the **[SHIFT]** button.

Beat FX is turned off, and Release FX is applied.

❖ **Switching Beat FX Tempo mode**

To set the tempo for Beat FX, there are 2 modes you can use: BPM Auto mode and BPM Tap mode.

- The default setting is BPM Auto mode.

BPM Auto mode

The track's BPM is used as the base for the effect's tempo.

BPM Tap mode

The BPM used as the base for Beat FX is set to match the tempo at which you tap the **[BEAT ►]** button while holding the **[SHIFT]** button.

Setting to BPM Auto mode/BPM Tap mode

Press the **[BEAT ►]** button while holding the **[SHIFT]** button to set to BPM Tap mode.

Press the **[BEAT ◀]** button while holding the **[SHIFT]** button to set to BPM Auto mode.

Using Smart CFX

- 1 Press the **[SMART CFX]** button while holding the **[SHIFT]** button.
The preset screen for Smart CFX is displayed to change the effect type.



- 2 Press the **[SMART CFX]** button.
Smart CFX turns on.
- 3 Turn the **[CFX]** knob.
The effect sound, etc. changes.

❖ Canceling Smart CFX

Press the **[SMART CFX]** button.
Smart CFX is turned off.

Using Smart Fader

- 1 Load tracks onto deck 1 and deck 2.
- 2 Press the **[SMART FADER]** button.
Smart Fader turns on.
 - When Smart Fader is turned on, Beat Sync turns on. (Beat Sync can't be canceled.)
 - When Smart Fader is turned on, some effects, EQ LOW, Beat Sync, etc. can't be controlled on the rekordbox for iOS/Android screen.
- 3 Slide the channel faders and crossfader to mix tracks.
 - Adjust the BPM for playback according to fader operation and the track.
 - EQ LOW is automatically adjusted according to fader operation.
 - The echo effect is automatically applied according to fader operation.
 - When sound outputs only from deck 1 due to fader operation, the BPM is adjusted to the real BPM of the track on deck 1. When sound outputs only from deck 2 due to fader operation, the BPM is adjusted to the real BPM of the track on deck 2. When sound outputs from deck 1 and deck 2 at the same volume, the BPM is adjusted to find the middle point of the difference between the BPM of the tracks on deck 1 and deck 2.
 - If the BPM of the tracks on deck 1 and deck 2 are significantly different, Smart Fader may not work properly because it is out of the tempo range.

Operation examples

(1): Deck 1, (2): Deck 2

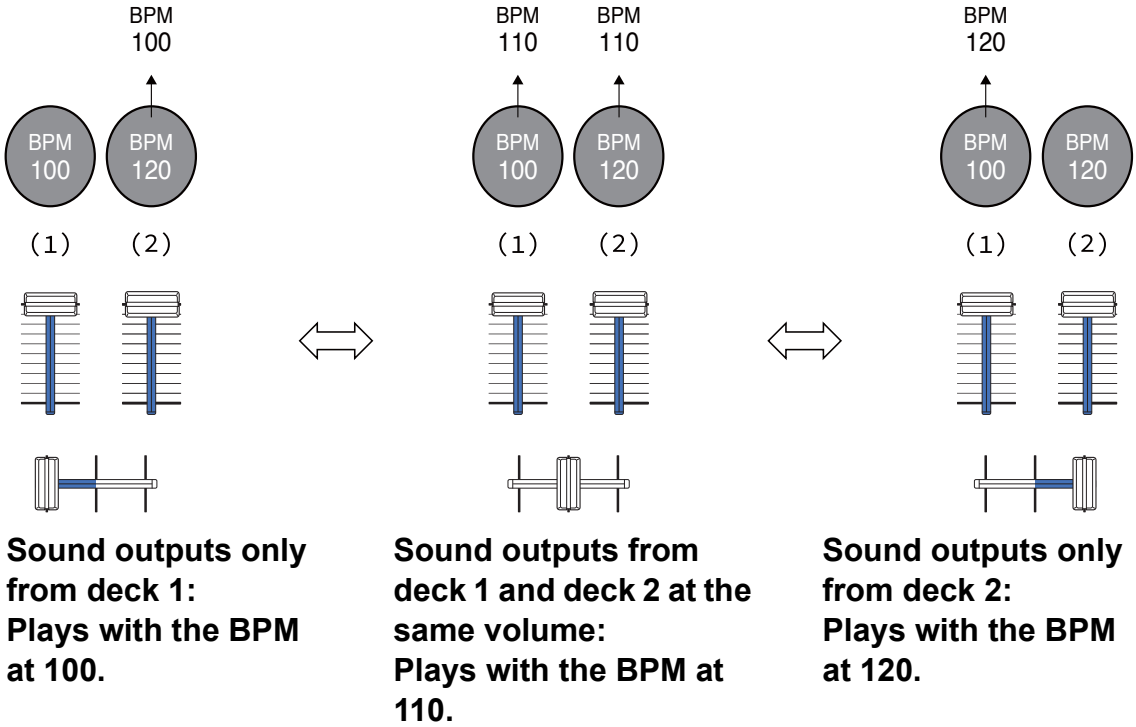

In this example, the BPM changes between 100 and 120.

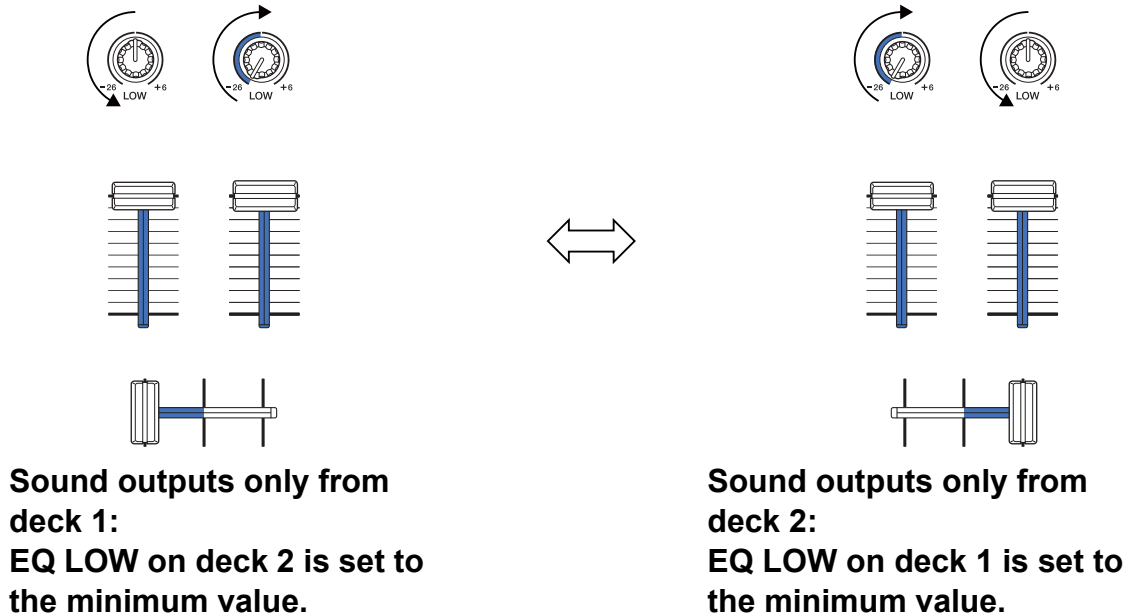

In this example, it changes as follows.

- Channel 1: When the crossfader position is between 1/3 and 2/3 from the left, the EQ LOW knob position changes from the center position to the minimum value.
- Channel 2: When crossfader position is between 1/3 and 2/3 from the left, the EQ LOW knob position changes from the minimum value to the center position.
- * The EQ LOW curve differs depending on the EQ LOW knob position and fader position, and mixing is automatically smooth.
- * The actual EQ LOW knob position isn't reflected on the rekordbox for iOS/Android screen, only the sound changes.

(1): Echo effect applied

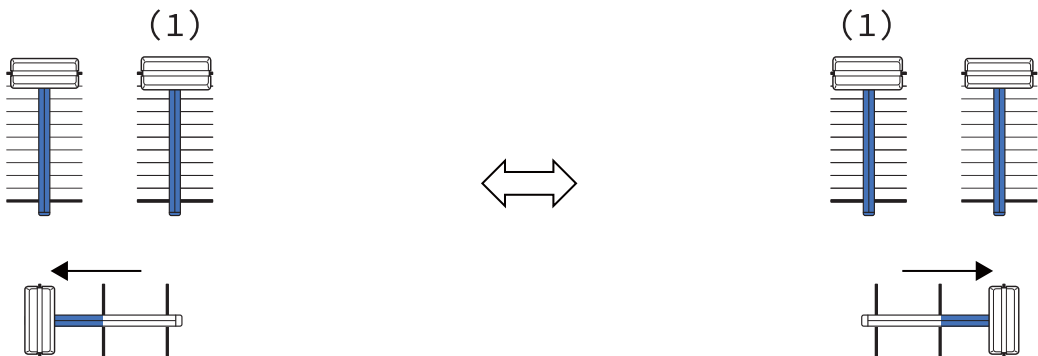

Sound outputs only from deck 1:
The echo effect is applied to the track on deck 2.

Sound outputs only from deck 2:
The echo effect is applied to the track on deck 1.

In this example, it changes as follows.

- Deck 1: The echo effect is applied when the crossfader is moved all the way to the right edge.
 - * The echo effect isn't applied when the crossfader is moved to the left starting from the right edge.
- Deck 2: The echo effect is applied when the crossfader is moved to the left edge.

- * The echo effect isn't applied when the crossfader is moved to the right starting from the left edge.
- You can select the fader to control Smart Fader in **[Settings]** > **[DDJ-FLX4 settings]** > **[Fader Used with SMART FADER]** in rekordbox for iOS/Android.

❖ Canceling Smart Fader



Press the **[SMART FADER]** button.
Smart Fader turns off.

Using a microphone

When connecting your mobile device to the unit with a USB cable, the microphone sound outputs from the **[MASTER]** output terminal or headphones output terminal of the unit.

- For microphone sound, there are **[Effect Mode]** which applies an effect to the sound and **[Low Latency Mode]** which doesn't apply an effect to the sound. Set **[Settings]** > **[DDJ-FLX4 settings]** > **[Microphone Input]** to **[Effect Mode]** (default) or **[Low Latency Mode]**.
 - ➡ Read: [Microphone Input] setting (page 141)
- When connecting your mobile device to the unit via Bluetooth, the microphone sound doesn't output from the **[MASTER]** output terminal or headphones output terminal of the unit.

❖ Using Effect Mode

- 1 Connect a microphone to the **[MIC]** input terminal.
- 2 Tap the  button on the rekordbox for iOS/Android screen to display the MIC panel, then tap .
- 3 Turn the **[MIC LEVEL]** knob.

rekordbox for iOS/Android

Adjust the volume of the sound output from the **[MIC]** input terminal.

- The sound comes out at a high volume if the knob is turned all the way to the right.

4 Input audio to the microphone.

You can use the microphone EQ, microphone effect, TALKOVER, FEEDBACK REDUCER, etc.

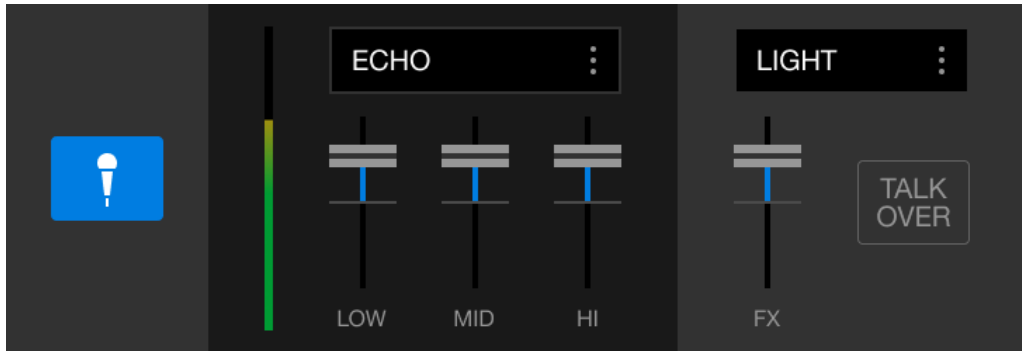

- To output the microphone sound from this unit via a mobile device, set **[Microphone Input]** to **[Effect Mode]**.
 - ➡ Read: [Microphone Input] setting (page 141)
- If **[Microphone Input]** is set to **[Low Latency Mode]** in rekordbox for iOS/Android, the microphone sound outputs from the unit another way.

Changing the settings in rekordbox for iOS/Android

You can change the settings of the unit in rekordbox for iOS/Android under **[DDJ-FLX4 Settings]** in **[Settings]**.

When you connect the unit to rekordbox for iOS/Android, you can change the following settings:

[BACK SPIN LENGTH] setting

When using the Back Spin feature with the jog wheel, the length of the Back Spin is different from the length of the jog wheel rotation.

You can choose the length of the Back Spin from 3 options: short, normal, or long.

- **[short]**: Back Spin length short
- **[normal]**: Back Spin length normal
- **[long]**: Back Spin length long

[Fader Start] setting

Change the setting of the Fader Start function.

[CROSSFADER] > [REVERSE] setting

Assign the decks to different sides of the crossfader.

- ON: The left side of the crossfader is assigned to **[DECK2]** and the right side is **[DECK1]**.
- OFF: The left side of the crossfader is assigned to **[DECK1]** and the right side is **[DECK2]**.

[CROSSFADER] > [Cut Lag] setting

Adjust the Cut Lag on both edges of the crossfader.

Units of 0.1 mm can be adjusted from 0.3 mm to 5.5 mm.

- The default Cut Lag is 1.0 mm.
- This Cut Lag setting is a guide, and may not be exact.

[Level Meter] setting

Select the channel level meter or master level meter to show on the level meter in the mixer section.

The default setting is **[Channel Level]**.

- **[Channel Level]**: Channel level meter
- **[Master Level]**: Master level meter

[Microphone Input] setting

- **[Effect Mode]**: Microphone sound can be output from the unit via a mobile device. You can apply effects such as the microphone FX in rekordbox for iOS/Android to the microphone sound.
- **[Low Latency Mode]**: Microphone sound can be output from the unit another way (i.e. not a mobile device). You can't apply effects such as the microphone FX in rekordbox for iOS/Android to the microphone sound, but the time lag due to the transmission delay (latency) of the sound data can be reduced compared to Effect mode.

[Talkover Mode] setting

Change MIC Talkover mode.

- **[Advanced]**: Only the mid-range sound, other than the microphone channel, is attenuated according to the set value of the MIC talkover level.

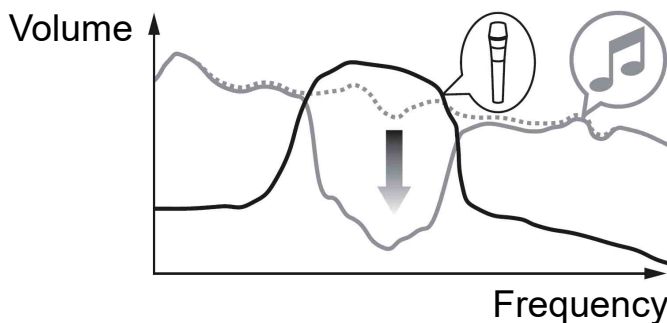

- **[Normal]**: Sound, other than the microphone channel, is attenuated according to the set value of the MIC talkover level.

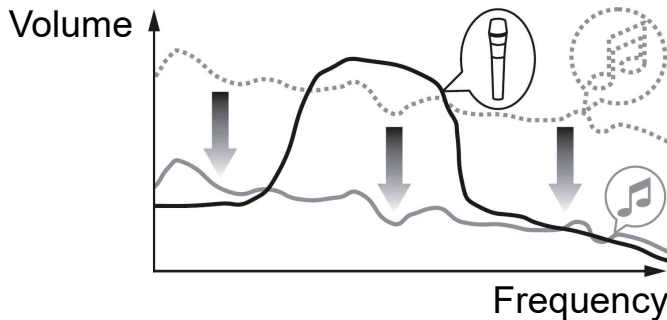

[Talkover Level] setting

Set the audio attenuation level of Mic talkover mode.

Setting values: -6 dB / -12 dB / -18 dB / -24 dB

SMART FADER setting

Select the fader to be used for Smart Fader.

- **[CROSSFADER and Channel fader]**: Smart Fader turns on when you move the crossfader or a channel fader.
- **[CROSSFADER]**: Smart Fader turns on when you move the crossfader.
- **[Channel fader]**: Smart Fader turns on when you move a channel fader.

When **[Use the recommended SMART FADER curve]** is on, the curve changes to the recommendation for Smart Fader.

[Master output] > [Monaural/Stereo Selection] setting

Change whether mono or stereo sound is output from the **[MASTER]** output terminal.

- **[Monaural]**: Outputs in mono.
- **[Stereo]**: Outputs in stereo.

[Master output] > [Peak Limiter] setting

Prevent sudden and unpleasant digital clipping of audio output from the **[MASTER]** output terminal.

- ON: The peak limiter of the master output is enabled.
- OFF: The peak limiter of the master output is disabled.

Changing the settings

Launching Utilities mode

Be sure to close your DJ application and then launch Utilities mode.

To use Utilities mode when connected to rekordbox for Mac/Windows or rekordbox for iOS/Android, set it on the preferences screen in rekordbox for Mac/Windows or rekordbox for iOS/Android.

➡ Read: Changing the settings in rekordbox for Mac/Windows (page 77)

➡ Read: Changing the settings in rekordbox for iOS/Android (page 140)

(To use Demo mode, set it on the unit.)

- 1 Disconnect the USB cable.
- 2 Hold both the **[SHIFT]** and **[PLAY/PAUSE ►/||]** buttons on the left deck and connect the USB cable.
Utilities mode launches.
- 3 Change the settings.
When you change the settings, they will be saved. While saving, the bottom row of Performance Pads on the left deck flashes. If you disconnect the USB cable while the pads are flashing, settings may not be saved.
- 4 Disconnect the USB cable to turn off the unit.
Utilities mode turns off.

Utilities mode settings

You can change the following settings in Utilities mode:

- Back Spin Length
- Fader Start
- Crossfader Reverse
- Crossfader Cut Lag
- Demo mode

❖ Back Spin Length

When using a jog wheel to perform a Back Spin, you can make the Back Spin longer or shorter than the amount you rotate the jog wheel by.

You can set the Back Spin Length to short, normal, or long.

Press one of the Performance Pads 5 through 7 on the left deck.

- Pad 5 is lit: Back Spin Length short
- Pad 6 is lit: Back Spin Length normal (Default)
- Pad 7 is lit: Back Spin Length long

❖ Fader Start

Press the **[HOT CUE]** mode button on the left deck.

- **[HOT CUE]** mode button is lit: Fader Start is turned on. (Default)
- **[HOT CUE]** mode button is not lit: Fader Start is turned off.

❖ Crossfader Reverse

You can switch the left and right of the crossfader to the opposite side.

Press the **[PAD FX1]** mode button on the left deck.

- The **[PAD FX1]** mode button is lit: Cross Reverse is turned on.
The left side of the crossfader is now for deck 2 and the right side is for deck 1.

Changing the settings

- The **[PAD FX1]** mode button is not lit: Cross Reverse is turned off. (Default)

The left side of the crossfader is for deck 1 and the right side is for deck 2.

❖ Crossfader Cut Lag

You can adjust the cut lag (the range where no sound is heard from the relevant deck) at both edges of the crossfader.

You can make adjustments in increments of 0.1 mm within a range of 0.3 mm to 5.5 mm. (Setting value: 1 through 53)

- The setting amount for the Cut Lag is a guide, and may not be exact.
- The default Cut Lag amount is 1.0 mm. (Setting value: 8)

Turn the rotary selector.

The number of lights that are lit up on the channel level indicators and Performance Pads indicates the setting value (1 through 53).

- The number of lights that are lit up on Performance Pads on the right deck: tens place.
- The sum of the number of lights that are lit up on the channel level indicators on channel 1 and 2: ones place.

E.g. 2 lights on Performance Pads on the right deck, plus 3 lights on channel 1, plus 5 lights on channel 2 means the total value is 28 (20 + 3 + 5 = 28).

❖ Demo mode

In normal conditions, if you don't use any features for a specified amount of time, the unit will enter Demo mode.

- When any knob or button on the unit is used during Demo mode, Demo mode is canceled.

Press one of the Performance Pads 1 through 4 on the left deck.

- Pad 1 is lit: Demo mode is switched off.

Changing the settings

- Pad 2 is lit: Demo mode starts when you don't use the unit for 1 minute.
- Pad 3 is lit: Demo mode starts when you don't use the unit for 5 minutes.
- Pad 4 is lit: Demo mode starts when you don't use the unit for 10 minutes. (Default)

Changing the Bluetooth® MIDI device name

Before you potentially use other units, you can set the unit to be identified by your mobile device.

You can change the Bluetooth MIDI device name displayed for the Bluetooth connection between the unit and your mobile device.

- The Bluetooth MIDI device name setting can't be saved.

- 1 Disconnect the USB cable to turn off the unit.
- 2 Hold down the relevant pad on the left or right deck and connect the USB cable.

The relationship between Bluetooth MIDI device names and Performance Pads is as follows.

For deck 1

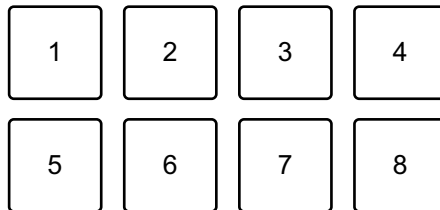

1: DDJ-FLX4_1, 2: DDJ-FLX4_2, 3: DDJ-FLX4_3, 4: DDJ-FLX4_4,
5: DDJ-FLX4_5, 6: DDJ-FLX4_6, 7: DDJ-FLX4_7, 8: DDJ-FLX4_8

For deck 2

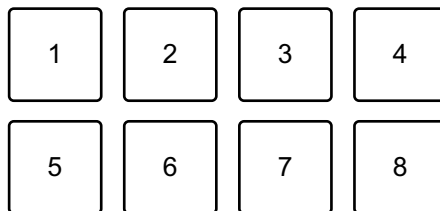

1: DDJ-FLX4_9, 2: DDJ-FLX4_10, 3: DDJ-FLX4_11, 4: DDJ-FLX4_12,
5: DDJ-FLX4_13, 6: DDJ-FLX4_14, 7: DDJ-FLX4_15, 8: DDJ-FLX4_16

Changing the settings

- 3 Connect rekordbox for iOS/Android to the unit via Bluetooth.
 - ➔ Read more: Connecting via Bluetooth (page 110)

Additional information

Troubleshooting

If you think something is wrong with the unit, check the information below and refer to the **[FAQ]** for the DDJ-FLX4 on the Pioneer DJ website.

pioneerdj.com/support/

Sometimes, the problem may be caused by another device. Inspect the other devices and electrical appliances you're using and refer to their manuals and FAQ if necessary. If the problems continue, read the Precautions for Use and consult an authorized service company or your dealer.

- The unit may not work properly if it's subjected to static electricity or other external influences. In this case, turn the unit off and on again to restore proper operation.

Power

❖ The unit does not power up.

- Connect the USB power adapter (or mobile battery) and USB cable correctly. See: Connections (page 37)
- Change the USB power adapter (or mobile battery) or USB cable.

❖ The unit powers down arbitrarily.

- Use a mobile battery which does not have a power-saving function. The maximum voltage is 24V or less and DC 9V 3A for the mobile battery.
Use a USB cable certified to the appropriate standard.

- ❖ **The [IN] button and [OUT] button on both decks flash and don't work.**
 - The supply capacity of the USB power adapter or mobile battery connected to the unit's USB port (for power supply) may be insufficient. Use a device with DC 9V 3A.

Connection

- ❖ **The unit isn't recognized by your PC/Mac.**
 - Connect the supplied USB cable correctly. See: Connections (page 37)
 - When using a USB hub, be sure it's a product recommended by the manufacturer of your PC/Mac.
 - Quit any other open applications including screen savers and antivirus security software on your PC/Mac. (When quitting antivirus security software, before doing so, disable the internet connection to ensure the security of your PC/Mac.)
 - Disconnect any external hard disk, keyboard, etc. Use the internal hard disk only.
 - If your PC/Mac has multiple USB ports, try connecting to another one.
 - For Mac, launch the macOS utility software **[Audio MIDI Setup]**, and click **[Windows]** on the menu bar and check that > **[Show Audio Devices]** > **[DDJ-FLX4 Audio Out]** is displayed.
 - For Mac, the sound setting may not be correct. Disconnect the USB cable, launch the macOS utility software **[Audio MIDI Setup]**, and display **[MIDI Window]** or **[MIDI Studio]**. Select the **[DDJ-FLX4]** icon, and click **[Remove Device]**. (The icon may be **[USB MIDI Device]** instead of **[DDJ-FLX4]**. In this case, select **[USB MIDI Device]**.) Connect the unit with the USB cable again. The **[DDJ-FLX4]** icon is displayed.
 - For Windows, check that **[DDJ-FLX4]** is displayed under **[Device Manager]** > **[Sound, video and game controllers]**.

- ❖ **When using a USB connection, the unit isn't recognized by a mobile device.**
 - Connect the USB power adapter (or mobile battery) and USB cable correctly. See: Connections (page 37).
 - Change the USB power adapter (or mobile battery) or USB cable.
- ❖ **Bluetooth connection cannot be established. / Bluetooth connection is interrupted.**
 - If devices generating electromagnetic waves in the 2.4 GHz band (such as a microwave oven, wireless LAN or another Bluetooth device) are located nearby, move them away from the unit or stop using them.
 - If your mobile device is far away, move it closer to the unit. If there is a wall, obstacle, etc. which may be interrupting the connection, move your mobile device or the unit.

Sound

- ❖ **Sound isn't output, is too quiet, or is distorted.**
 - Set the **[TRIM]** knob, channel fader, crossfader, and **[MASTER LEVEL]** knob to the correct positions. See: Playing a track (page 51) (page 88) (page 114)
 - Connect the connection cable properly. See: Connections (page 37)
 - Clean the terminals and plugs before connecting the cable to the unit.
 - If sound is distorted, change the buffer size for your DJ software.
- ❖ **Microphone sound can't be output.**
 - Set the **[MIC ATT.]** knob and **[MIC LEVEL]** knob to the correct positions. See: Mixer section (page 25) Rear panel (page 34)

❖ **Headphones sound is too quiet.**

- When the power supply from the USB port is insufficient, the unit limits the volume of headphones. Disconnect devices you're not using for DJing to direct more power to the unit.

rekordbox for Mac/Windows

❖ **rekordbox becomes unstable.**

- Update rekordbox to the latest version. See: Installing rekordbox for Mac/Windows (page 45)
- Quit any other applications on your PC/Mac. If rekordbox remains unstable, try disabling the wireless network or other wireless connections, antivirus software, screen saver, low-power mode, etc. (When quitting antivirus security software, before doing so, disable the internet connection to ensure the security of your PC/Mac.)
- If another USB device is connected to your PC/Mac, disconnect it.
- When using a USB hub, be sure it's a product recommended by the manufacturer of your PC/Mac.
- If you're using battery power for your laptop, connect the laptop to an AC power supply.

❖ **BPM and beatgrid are not displayed correctly./Beatgrid is misaligned.**

- Change the BPM analysis range and analyze the track again. If it doesn't work, manually set the beatgrid and BPM.
- Adjust the beatgrid. For details on how to adjust the beatgrid, see the rekordbox Instruction Manual.

❖ **Sound is interrupted while using rekordbox for Mac/Windows.**

- Set the buffer size in **[Preferences] > [Audio]** in rekordbox for Mac/Windows.

❖ **Fader Start doesn't work.**

- Set a cue.
- To activate Fader Start, mark the **[Fader Start]** check box in **[Preferences] > [Controller] > [Mixer]** tab in rekordbox for Mac/Windows.

❖ **When the unit is disconnected, recording isn't available in rekordbox.**

- If you don't have one of the relevant subscription plans, you can't record without connecting to the unit. Connect the unit or another Hardware Unlock device, or take out one of the relevant subscription plans to enable recording.

Serato DJ Lite

❖ Serato DJ Lite becomes unstable.

- Update Serato DJ Lite to the latest version. See: Installing Serato DJ Lite (page 81)
- Quit any other applications on your PC/Mac. If Serato DJ Lite remains unstable, try disabling the wireless network or other wireless connections, antivirus software, screen saver, low-power mode, etc. (When quitting antivirus security software, disable the internet connection to ensure the security of your PC/Mac before doing so.)
- If another USB device is connected to your PC/Mac, disconnect it.
- When using a USB hub, be sure it's a product recommended by the manufacturer of your PC/Mac.
- If you're using battery power for your laptop, connect the laptop to an AC power supply.

❖ Tracks aren't displayed in the library.

- Import music files. See: Importing music files (tracks) (page 86)
- If you selected a crate or subcrate which doesn't contain any tracks, select another crate or subcrate which does contain tracks, or import tracks into the crate or subcrate.

❖ iTunes tracks aren't displayed in the library.

- Activate **[Show iTunes Library]** in the **[Library + Display]** tab of the **[SETUP]** menu. If **[Show iTunes Library]** is already selected, deactivate it, then activate it again. For details about importing music files, see the Serato DJ Lite software manual.
- If you selected a crate or subcrate which doesn't contain any tracks, select another crate or subcrate which does contain tracks, or import tracks into the crate or subcrate.

- ❖ **Serato DJ Lite virtual deck isn't displayed. (Practice mode is displayed.)**
 - Connect the supplied USB cable correctly. See: Connections (page 37)
 - Update Serato DJ Lite to the latest version. See: Installing Serato DJ Lite (page 81)

- ❖ **Fader Start doesn't work.**
 - Set temporary cue.
 - Use the Utilities mode to activate Fader Start. See: Fader Start (page 145)

- ❖ **BPM isn't displayed./SYNC and Auto Loop don't work.**
 - Click the gear icon next to the **[Analyze Files]** button, mark the **[Set BPM]** checkbox, then analyze the track. For details on how to analyze a track, see the Serato DJ Lite software manual.

- ❖ **BPM is not displayed correctly.**
 - Change the BPM analysis range and analyze the track again. If it still doesn't work, manually set the BPM.

- ❖ **The crossfader doesn't work.**
 - Cancel **[Disable]** in the crossfader settings in Serato DJ Lite.

rekordbox for iOS/Android

- ❖ **When connecting an Android device, stereo sound doesn't output correctly, MASTER output sound is distorted, then no sound outputs from headphones.**
 - If your Android device is connected with a USB cable, it may not connect correctly and the stereo sound may not output normally. In this case, set **[Android MONO/STEREO]** to **[MONO]** on the rear panel.

- ❖ **When the USB connection is in use, sound doesn't output from the mobile device.**
 - Sound doesn't output from the mobile device when the USB connection is in use. Connect a powered speaker, powered amplifier, etc. to the **[MASTER]** output terminal on the unit.

- ❖ **When connecting via Bluetooth, sound doesn't output from the [MASTER] output terminals or headphones output terminal on the unit.**
 - When using the Bluetooth connection, sound can't be output from the **[MASTER]** output terminals or headphones output terminal on the unit. Sound outputs from the mobile device instead.
If connecting with a USB cable, sound can be output from the **[MASTER]** output terminals and headphones output terminal on the unit.

❖ **When using the Bluetooth connection, sound from the microphone connected to the unit doesn't output.**

- Microphone sound can't be output from the **[MASTER]** output terminals or headphones output terminal on the unit when the Bluetooth connection is in use.

When the USB connection is in use, sound can be output from the **[MASTER]** output terminals and headphones output terminal on the unit.

❖ **rekordbox becomes unstable.**

- Update rekordbox to the latest version. See: Installing rekordbox for iOS/Android (page 107)
- Quit any other applications on your mobile device. If rekordbox remains unstable, try disabling the wireless network or other wireless connections, antivirus application, low-power mode, etc. (When quitting antivirus security software, before doing so, disable the internet connection to ensure the security of your mobile device.)

❖ **BPM and beatgrid are not displayed correctly./Beatgrid is misaligned.**

- Change the BPM analysis range and analyze the track again. If it doesn't work, manually set the beatgrid and BPM.

❖ **Fader Start doesn't work.**

- Set a cue.
- To activate Fader Start, set **[Fader Start]** to on in **[Settings] > [DDJ-FLX4 settings]** in rekordbox.

Specifications

General – Main Unit

Rated power supply

When a USB power adapter is usedDC 9 V, 3 A

When a USB bus power is used.....DC 5 V, 500 mA

Main unit weight..... 2.1 kg (4.6 lbs.)

Max. dimensions (W × D × H)

.....482 × 272.8 × 59.2 mm (18.98" × 10.74" × 2.33")

Tolerable operating temperature..... +5 °C – +35 °C (+41 °F – +95 °F)

Tolerable operating humidity..... 5 % – 85 % (no condensation)

Audio Section

Sampling rate44.1 kHz/48 kHz

A/D, D/A converters 16bit/24bit

Frequency characteristic

USB, MIC20 Hz – 20 kHz

S/N ratio (rated output, A-WEIGHTED)

USB 103 dB

Total harmonic distortion (20 Hz to 20 kHz BW)

USB 0.005 %

Input impedance

MIC 3 kΩ or more

Output impedance

MASTER 1 kΩ or less

Headphones 10 Ω or less

Rated output level / Load impedance

MASTER 2.1 Vrms/10 kΩ

Input / Output terminals

MIC input terminal

1/4" TS jack 1 set

MASTER output terminal

RCA pin jacks	1 set
Headphones output terminals	
3.5 mm stereo mini jack.....	1 set

USB port

USB (Type C)	2 sets
--------------------	--------

Bluetooth® Section

Wireless system	Bluetooth Low Energy
Maximum transmission distance	
.....	Approximately 10 m* in unobstructed circumstances
Frequency band used	2.4 GHz
Modulation method ...	FH-SS (Frequency hopping spread spectrum)

* Transmission distances are a guideline. Transmission distance may change depending on the surrounding environment.

- The specifications and design of this product are subject to change without notice.

Using the unit as a controller for other DJ applications

The unit also outputs operating data for the buttons and knobs in MIDI format. If you connect a PC/Mac with a built-in MIDI-compatible DJ application via the USB cable, you can control the DJ application with the unit. (You need to set MIDI details in the DJ application.)

- For details, see your DJ application's user guide.

About MIDI messages

For details on this unit's MIDI messages, see the List of MIDI Messages.

- You can find the List of MIDI Messages on the Pioneer DJ website: pioneerdj.com/

Trademarks and registered trademarks

- rekordbox™ is a trademark or registered trademark of AlphaTheta Corporation.
- Apple, Apple Logo, Apple Music, Finder, iPad, iPadOS, iTunes, Mac, MacBook, MacBook Pro, macOS and OS X are trademarks of Apple Inc., registered in the U.S. and other countries.
- App Store is a service mark of Apple Inc.
- Windows is a registered trademark of Microsoft Corporation in the United States and other countries.
- iOS is a trademark or registered trademark of Cisco Systems, Inc. in the U.S. and other countries and is used under license.
- Google Play, Google Play Logo and Android are registered trademarks of Google LLC.
- Serato DJ Lite, Serato DJ Intro, Serato DJ Pro, Serato DJ and Scratch Live are registered trademarks of Serato Limited.
- The *Bluetooth*® word mark and logos are registered trademarks owned by Bluetooth SIG, Inc. and any use of such marks by AlphaTheta Corporation is under license. Other trademarks and trade names are those of their respective owners.

Other product, technology and company names, etc. mentioned herein are trademarks or registered trademarks of their respective owners.

About using MP3 files

This product has been licensed for nonprofit use. This product has not been licensed for commercial purposes (for profit-making use), such as broadcasting (terrestrial, satellite, cable or other types of broadcasting), streaming on the Internet, Intranet (a corporate network) or other types of networks or distributing of electronic information (online digital music distribution service). You need to acquire the corresponding licenses for such uses. For details, refer to <http://www.mp3licensing.com>.

Software license notice

Apache

Copyright (c) 2009-2019 ARM Limited. All rights reserved.

SPDX-License-Identifier: Apache-2.0

Licensed under the Apache License, Version 2.0 (the License); you may not use this file except in compliance with the License. You may obtain a copy of the License at

www.apache.org/licenses/LICENSE-2.0

Unless required by applicable law or agreed to in writing, software distributed under the License is distributed on an AS IS BASIS, WITHOUT WARRANTIES OR CONDITIONS OF ANY KIND, either express or implied.

See the License for the specific language governing permissions and limitations under the License.

BSD

The BSD-3-Clause License

Copyright (c) 2015, Freescale Semiconductor, Inc.

Copyright 2016-2020 NXP

All rights reserved.

Redistribution and use in source and binary forms, with or without modification, are permitted provided that the following conditions are met:

1. Redistributions of source code must retain the above copyright notice, this list of conditions and the following disclaimer.

Additional information

2. Redistributions in binary form must reproduce the above copyright notice, this list of conditions and the following disclaimer in the documentation and/or other materials provided with the distribution.
3. Neither the name of the copyright holder nor the names of its contributors may be used to endorse or promote products derived from this software without specific prior written permission.

THIS SOFTWARE IS PROVIDED BY THE COPYRIGHT HOLDERS AND CONTRIBUTORS "AS IS" AND ANY EXPRESS OR IMPLIED WARRANTIES, INCLUDING, BUT NOT LIMITED TO, THE IMPLIED WARRANTIES OF MERCHANTABILITY AND FITNESS FOR A PARTICULAR PURPOSE ARE DISCLAIMED. IN NO EVENT SHALL THE COPYRIGHT HOLDER OR CONTRIBUTORS BE LIABLE FOR ANY DIRECT, INDIRECT, INCIDENTAL, SPECIAL, EXEMPLARY, OR CONSEQUENTIAL DAMAGES (INCLUDING, BUT NOT LIMITED TO, PROCUREMENT OF SUBSTITUTE GOODS OR SERVICES; LOSS OF USE, DATA, OR PROFITS; OR BUSINESS INTERRUPTION) HOWEVER CAUSED AND ON ANY THEORY OF LIABILITY, WHETHER IN CONTRACT, STRICT LIABILITY, OR TORT (INCLUDING NEGLIGENCE OR OTHERWISE) ARISING IN ANY WAY OUT OF THE USE OF THIS SOFTWARE, EVEN IF ADVISED OF THE POSSIBILITY OF SUCH DAMAGE.

Cautions on copyrights

rekordbox restricts playback and duplication of copyright-protected music contents.

- When coded data, etc., for protecting the copyright is embedded in the music contents, it may not be possible to operate the program normally.
- When rekordbox detects that coded data, etc., for protecting the copyright is embedded in the music contents, processing (playback, reading, etc.) may stop.

Recordings you have made are for your personal enjoyment and according to copyright laws may not be used without the consent of the copyright holder.

- Music recorded from CDs, etc., is protected by the copyright laws of individual countries and by international treaties. It is the full responsibility of the person who has recorded the music to ensure that it is used legally.
- When handling music downloaded from the Internet, etc., it is the full responsibility of the person who has downloaded the music to ensure that it is used in accordance with the contract concluded with the download site.

The specifications and design of this product are subject to change without notice.

© 2022 AlphaTheta Corporation

All rights reserved.

<DRI1804-A>