

Instruction Manual

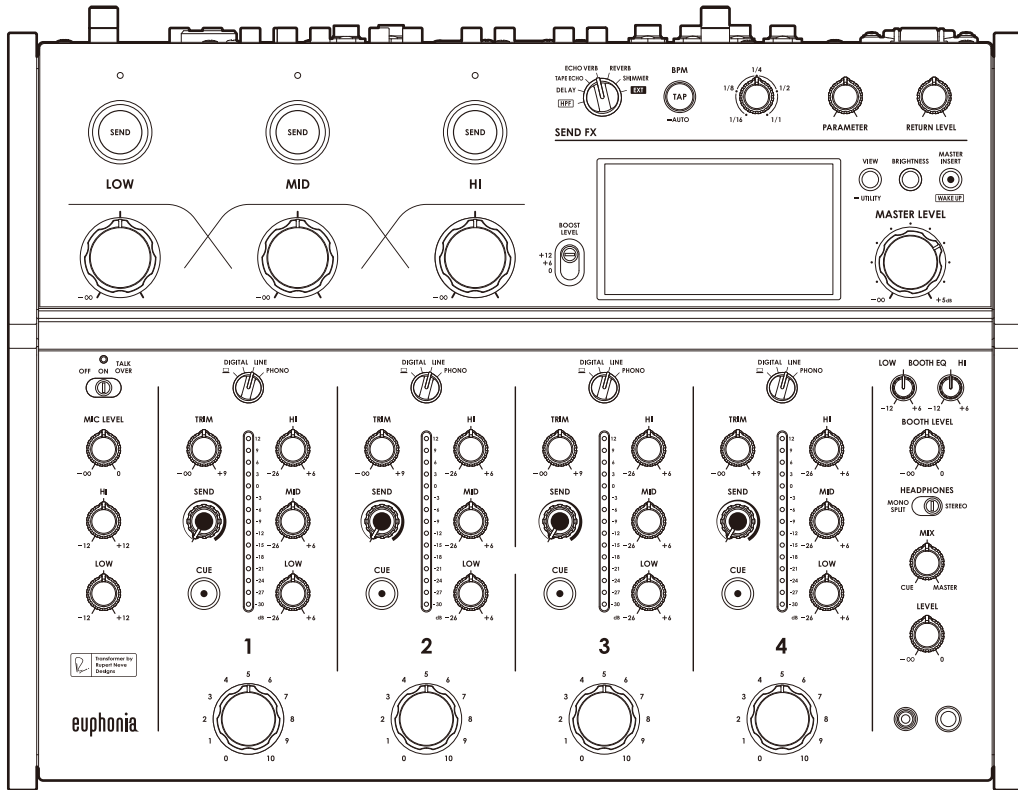

DJ Mixer

euphonia

alphatheta.com/support/

rekordbox.com

For FAQ and other support information for this product, visit the websites above.

Contents

Before you start	5
Features	5
How to read this manual	5
What's in the box.....	6
User guides	6
Part names	7
Top panel	7
Rear panel.....	8
Display section	10
PC/Mac setup	13
Installation	13
Setting Utility	15
Connections	21
Connecting to the input terminals.....	21
Connecting to the output terminals	22
Connecting to the terminals on the top panel.....	23
Connecting external effects units	24
Audio output	26
Channel section/master section	26
Outputting sound	28
Adjusting the sound of the channels	29
Adjusting the left/right sound balance	29
Master Isolator	31
Master Isolator section	31
Adjusting the master sound.....	32
Monitoring sound	33

Headphones section	33
Monitoring with headphones	34
Booth section	35
Using a booth monitor	35
Microphone	36
MIC section	36
Using a microphone	37
SEND FX	38
SEND FX section	38
Applying High-Pass Filter (HPF) to the channel sound	39
Routing effect sounds to the master output	40
Setting the BPM manually	41
SEND FX types and settings	42
Master Insert	44
Using Master Insert	44
USB/MIDI	45
USB/MIDI section	45
Controlling MIDI software	45
Settings	46
UTILITY screen	46
Changing the settings	47
Utility settings	48
Restoring the factory settings	50
Specifications	51
Block diagram	54
Additional information	56
Troubleshooting	56
LCD display	59
Trademarks and registered trademarks	60

Software license notice	61
Cautions on copyrights.....	66

Before you start

Features

Thank you for choosing this product which is named for euphonia birds, meaning “good sound”.

This 4-channel mixer enables dynamic performances and smooth mixing with the rotary faders. You can intuitively operate the controls on the minimalistic top panel and visually grasp the volume level via the Mix Level Meter.

The unit produces a glossy and rich digital-analog hybrid audio thanks to the digital signal processing we developed, which generates sound that’s faithful to the original source, and the transformer that we co-developed with Rupert Neve Designs.

Enjoy performances that will take you on a new sound journey with the euphonia.

How to read this manual

- Be sure to read this manual, the Quick Start Guide and the Precautions for Use which are also included with the product. These documents include important information that you should understand before using the unit.
- In this manual the names of buttons, knobs, and terminals that appear on the product, and the names of buttons, menus etc. in the software on your PC/Mac or mobile device, are indicated within square brackets ([]). (e.g. **[File]**, **[CUE]** button)
- Please note that the software screens and their specifications, as well as the external appearance and specifications of the hardware, are subject to change without notice.
- Please note that depending on the operating system version, web browser settings, etc. operation may differ from the ways described in this manual.
- Please note that the language on the screens of the software described in this manual may differ from the language on your screen.

What's in the box

- Power cord
- Warranty (for some regions)^{*1}
- Quick Start Guide
- Precautions for Use

*1 Only products in Europe.

Products in North America and Japan include warranty information in the Precautions for Use.

User guides

❖ rekordbox Introduction, Instruction Manual

Refer to the rekordbox Introduction to find out how to set up rekordbox, and see the Instruction Manual to find out how to use rekordbox.

Visit the URL below to find these user guides.

rekordbox.com/manual

Part names

Top panel

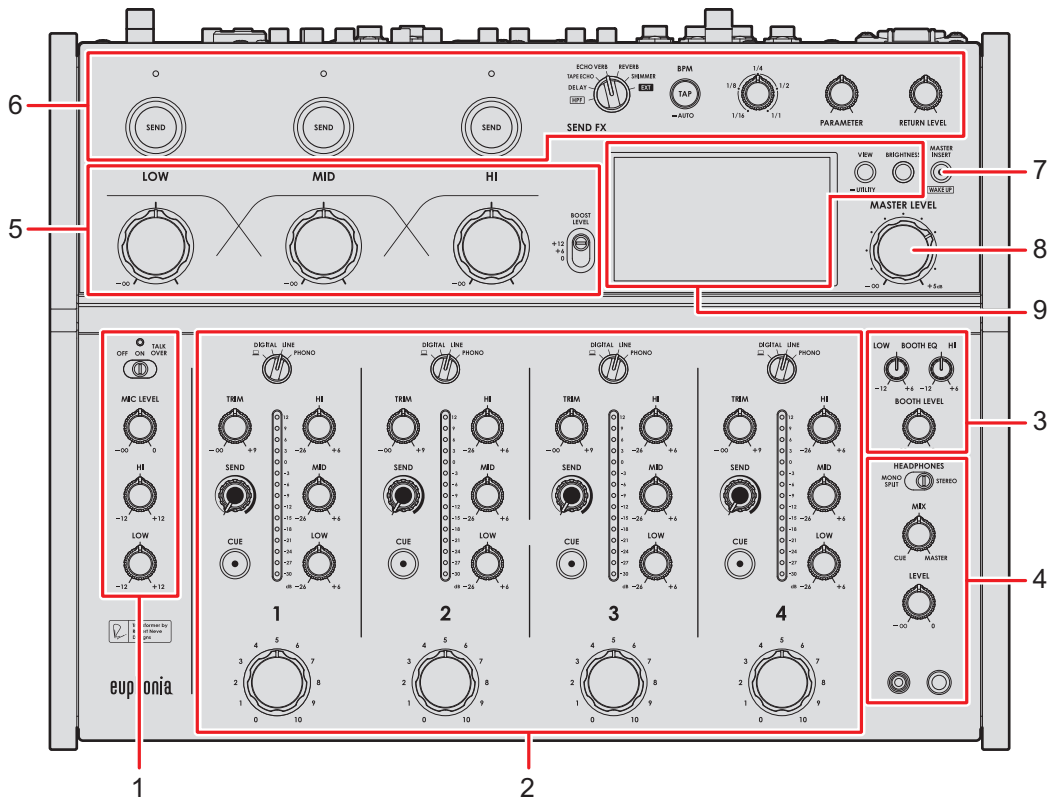

1. **MIC section** (page 36)
2. **Channel section** (page 26)
3. **Booth section** (page 35)
4. **Headphones section** (page 33)
5. **Master Isolator section** (page 31)
6. **SEND FX section** (page 38)
7. **MASTER INSERT/(WAKE UP) button** (page 44)
 - Turns Master Insert on and off. The button blinks when it's turned on.
 - Press while in Power Management Off mode to exit Off mode.
8. **MASTER LEVEL knob** (page 26)
9. **Display section** (page 10)

Rear panel

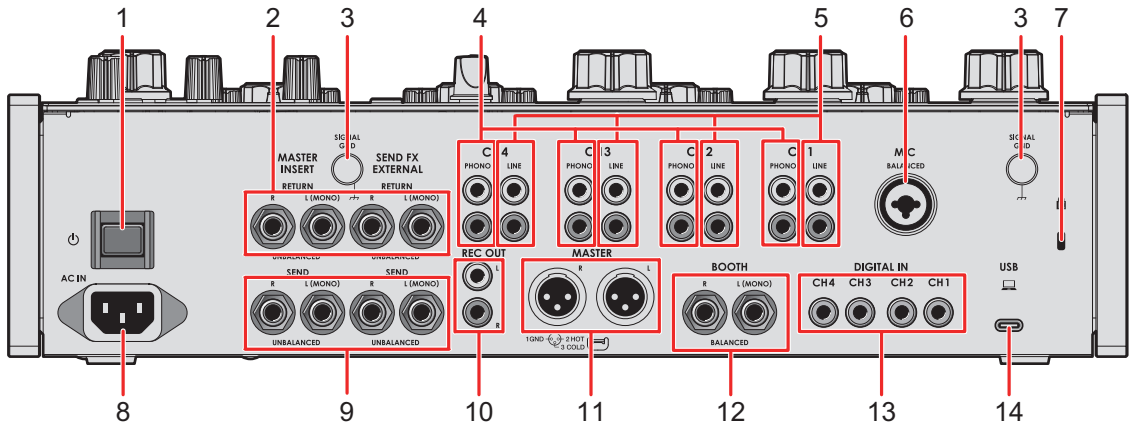

1. **⏻ button**

Turns the unit on and off.

2. **MASTER INSERT/SEND FX EXTERNAL RETURN terminals (1/4"/6.35 mm, TS)** (page 24)

Connect to output terminals on external effects units.

- If you connect a device to the [L (MONO)] terminal only, the sound input to the [L (MONO)] terminal is also input to the [R] channel.

3. **SIGNAL GND terminal** (page 21)

Connect a turntable's ground wire.

Reduces unwanted noises that occur when a turntable is connected to the unit.

4. **PHONO terminals (RCA)** (page 21)

Connect phono-level (MM cartridge) output devices.

- Do not input line-level signals to the terminals.
- Remove the short-circuit pin plugs from the terminals when connecting devices. When you aren't using the terminals, attach the short-circuit pin plugs to cut out external noises.

⚠ WARNING

Keep the short-circuit pin plugs out of the reach of children and infants. If a part is accidentally swallowed, contact a doctor immediately.

5. **LINE terminals (RCA)** (page 21)

Connect multi players or line-level output devices.

6. **MIC terminal (XLR or 1/4"/6.35 mm, TRS)** (page 21)
7. **Kensington security slot**
Connect a cable lock.
8. **AC IN** (page 21)
Connect to a power outlet with the supplied power cord.
9. **MASTER INSERT/SEND FX EXTERNAL SEND terminals (1/4"/6.35 mm, TS)** (page 24)
Connect to input terminals on external effects units.
 - If you connect a device to the [**L (MONO)**] terminal only, mono sound is output.
10. **REC OUT terminals (RCA)** (page 22)
Connect a device for recording. You can use them as output terminals for a power amplifier, etc.
11. **MASTER terminals (balanced XLR)** (page 22)
Connect to analog input terminals on a power amplifier, etc.
 - Use the terminals for balanced output only.
 - Do not connect a power cord from another product to the terminals.
 - Do not connect to a terminal that can supply phantom power.
12. **BOOTH terminals (1/4"/6.35 mm, TRS)** (page 22)
Connect a booth monitor.
 - Use the terminals for balanced output only.
 - If you connect equipment to the [**L (MONO)**] terminal only, mono sound is output.
13. **DIGITAL IN terminals (RCA)** (page 21)
Connect to a digital coaxial output terminal on a multi player, etc.
 - Sound may break when the signal's sampling frequency changes.
14. **USB port** (page 22)
Connect a PC/Mac.

Display section

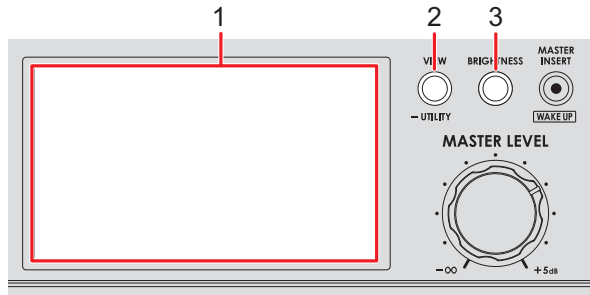

1. **Screen** (page 10)
2. **VIEW/UTILITY button**
Switches the display types.
3. **BRIGHTNESS button**
Sets the brightness of the screen.

Main display

The screen shows the status of the sound being played.

Press the [VIEW/UTILITY] button to switch between Needle View and Digital View.

- Needle View: Shows the status of sound with the Mix Level Meter with meter needles, and Spectrum Analyzer.
- Digital View: Shows the status of sound with the Mix Level Meter in columns chart, and Spectrum Analyzer.
- Needle View is displayed when the unit is turned on.

Needle View:

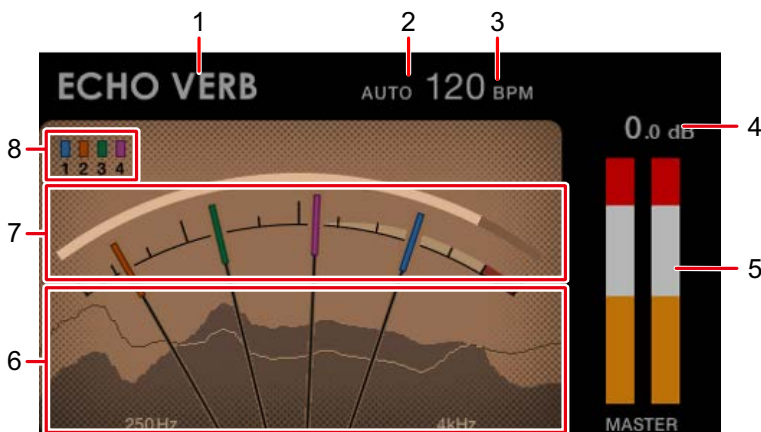

Digital View:

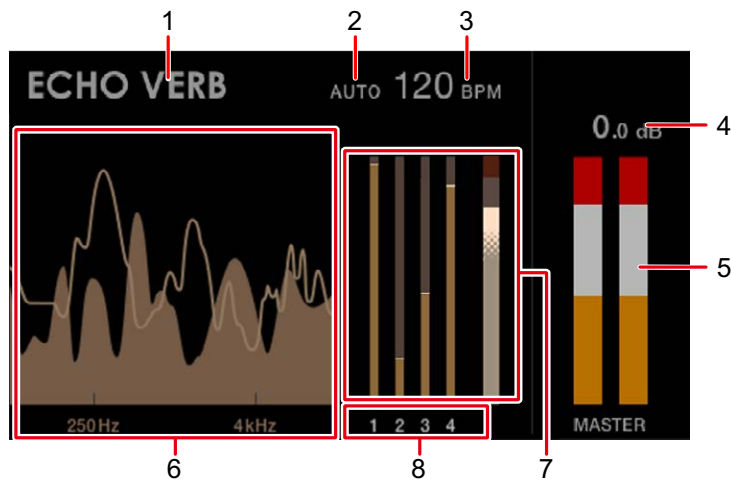
1. **Effect name**

Displays the selected effect.

2. **AUTO/TAP**

Displays [**AUTO**] when in automatic BPM measuring mode, and [**TAP**] when in manual BPM input mode.

- The BPM value blinks when it can't be measured correctly in the [**AUTO**] setting. Use the [**TAP**] mode if this happens.

3. **BPM value**

Displays the current BPM.

4. **Peak level**

Displays the peak level of the master sound output to the [**MASTER**] or [**REC OUT**] terminals. [**CLIP**] is displayed when excessive volume is output.

5. **Peak level meter**

Displays the peak level in a meter for the master sound output to the [**MASTER**] or [**REC OUT**] terminals.

6. **Spectrum Analyzer**

Shows the frequency spectrum for the master sound (doesn't reflect the setting of the [**MASTER LEVEL**] knob) and mix sound (doesn't reflect the setting of the Master Isolator) as follows.

- Master sound: Shown by a spectrum with filled area
- Mix sound: Shown by a spectrum with a line

7. Mix Level Meter

Shows the volume of each channel (sound adjusted with the channel rotary fader) and the master sound (doesn't reflect the setting of the **[MASTER LEVEL]** knob). You can compare the relative volume of each sound.

- Depending on the sound being played, the volume of the master sound may be shown as lower than the volume of the channel sound.
- You can add a moderate amount of saturation to the master sound by adjusting the volume of the master sound so it's in the white range shown below.

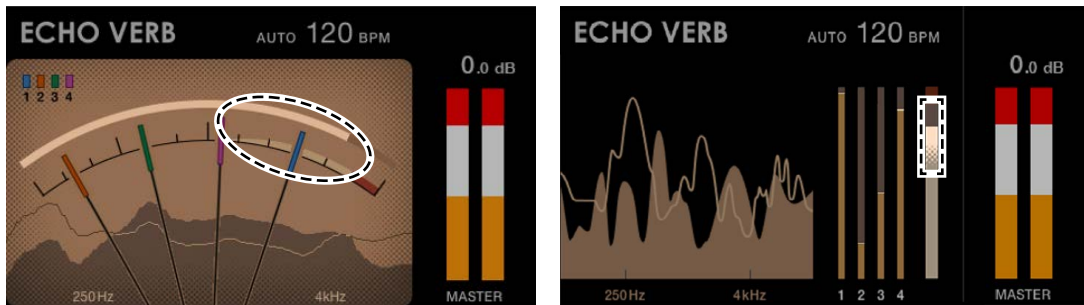

8. Channel numbers

The numbers indicate the channels assigned to the Mix Level Meters.

- In the Needle View, the colors assigned to the numbers correspond to the colors on the needles.
- In the Digital View, the channel number assigned to each Mix Level Meter is shown below the meter.

PC/Mac setup

To input or output your PC/Mac's audio to/from the unit, install the dedicated audio driver software and/or Setting Utility on your computer.

If you install the dedicated software to your PC (Windows), the Setting Utility and audio driver software will be installed.

If you use a Mac, only the Setting Utility will be installed.

- For information on the latest system requirements, compatibility, and supported operating systems, visit the URL below.

alphatheta.com/support/

- Operation isn't guaranteed on all PC/Mac models, even if the system requirements are met.
- Operation isn't guaranteed when multiple units are connected to a PC/Mac.
- If a PC (Windows) without the dedicated audio driver software installed is connected to the unit, errors may occur on the PC.
- Malfunctions may occur due to incompatibility with other software installed on a PC/Mac.

Installation

❖ Notes on installation

- Turn the unit off and disconnect the USB cable connected to the unit and the PC/Mac before installation.
- Close all applications running on the PC/Mac before installation.
- You'll need admin rights to install the dedicated software on your PC/Mac.
- Read the Software License Agreement terms carefully before installation.
- If you quit the installation halfway through, perform the installation procedure again from the beginning.
- After the installation is complete, connect the PC/Mac to the unit.
- Operation isn't guaranteed on all PC/Mac models.

Downloading the dedicated software

1 Visit the URL below.

alphatheta.com/support/

2 Click [Software & firmware updates].

3 Click [EUPHONIA] under [DJ MIXER].

4 Click [Drivers].

5 Click [Download link] and save the file.

- Download the software dedicated to your PC/Mac.

Installing the dedicated software

1 Unzip the downloaded dedicated software.

2 Double-click the installation file.

- Double-click “euphonia_#.###.exe” if you’re using a PC (Windows), or “euphonia_M_#.#.dmg” → “euphoniaSettingUtility.pkg” if you’re using a Mac (# indicates the version number of the software).

3 Read the Software License Agreement terms carefully.

If you agree to the terms, mark the [Agree] check box and click [OK].

- If you don’t agree to the Software License Agreement terms, click [Disagree] (for Mac)/[Cancel] (for Windows) to cancel the installation.

4 Follow the on-screen instructions to complete the installation.

Setting Utility

Once you've installed the dedicated software on your PC/Mac, you can use the Setting Utility to check and set connections between the unit and a PC/Mac.

Launching Setting Utility

❖ For Mac

- 1 Open the [Applications] folder in Finder.
- 2 Click [AlphaTheta] → [euphonia] → [euphonia Setting Utility].

❖ For PC (Windows 11)

- 1 Open the Start menu and click [All Apps] → [AlphaTheta] → [euphonia Setting Utility].

❖ For PC (Windows 10)

- 1 Open the Start menu and click [AlphaTheta] → [euphonia Setting Utility].

Checking the status of the input selector switches on the unit

1 Click the [MIXER INPUT] tab.

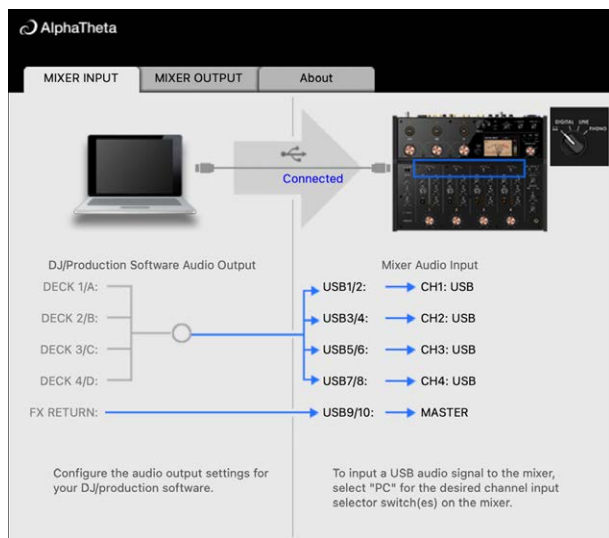

Setting the audio data output from the unit to a PC/Mac

- 1 Click the **[MIXER OUTPUT]** tab.
- 2 Click the pull-down lists under **[Mixer Audio Output]** and set the audio data to output from the unit to the PC/Mac.

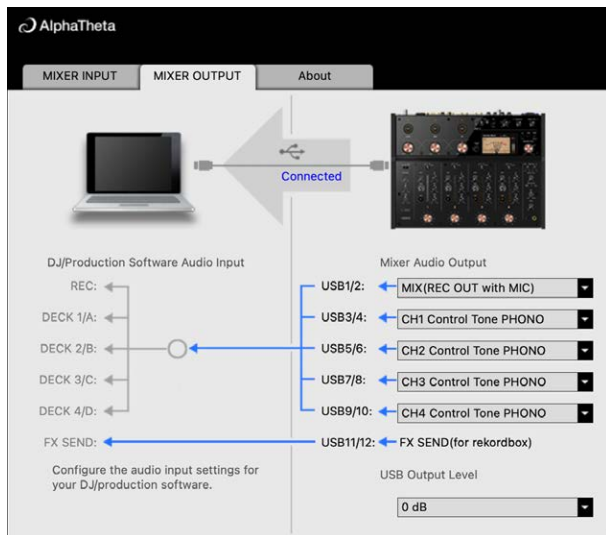

➡ Read more: Mixer Audio Output pull-down list (page 20)

- 3 Click the pull-down list under **[USB Output Level]** and select a level of volume to output from the unit.

- Set the volume in **[USB Output Level]** when you can't produce as much volume as you expect using the volume adjustment in your DJ application. Note that the sound may be distorted if you set the volume too high.

Adjusting the buffer size (for Windows ASIO)

- Close any running applications (DJ applications, etc.) which use the unit as the default audio device before adjusting the buffer size.

1 Click the [ASIO] tab.

2 Adjust the buffer size with the slider.

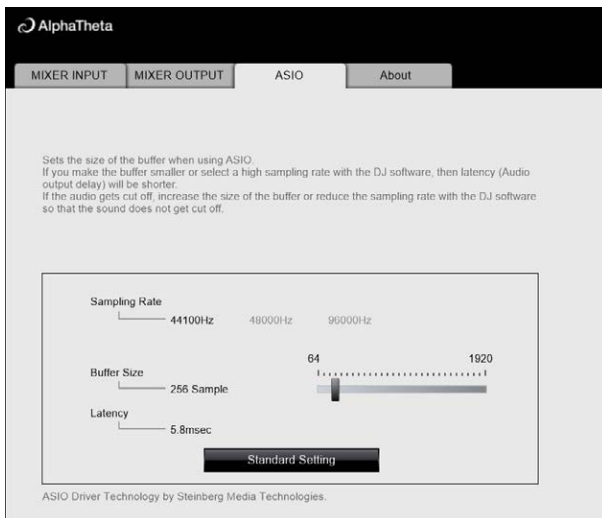

- Breaks in sound are less likely to occur if you set a large buffer size, but this increases lag time due to the latency of audio data transmission.

Checking the firmware and dedicated software versions

1 Click the [About] tab.



Mixer Audio Output pull-down list

- USB 11/12 is fixed to **[FX SEND (for rekordbox)]** (available for software applications that support the function).

#: indicates channel number

USB 1/2	USB 3/4, USB 5/6, USB 7/8, USB 9/10
MIX(REC OUT with MIC) ¹	CH# Control Tone PHONO ²
Pre CH1 Fader	CH# Control Tone LINE ²
Pre CH2 Fader	CH# Control Tone DIGITAL ²
Pre CH3 Fader	Pre CH# Fader
Pre CH4 Fader	Post CH# Fader
Post CH1 Fader	MIC
Post CH2 Fader	MIX(REC OUT with MIC) ¹
Post CH3 Fader	MIX(REC OUT without MIC) ¹
Post CH4 Fader	-
MIC	-
MIX(REC OUT without MIC) ¹	-

¹ For uses other than recording, be sure to set the DJ application so that no sound loop occurs. Sound may be input or output at an unintended volume level when a sound loop occurs.

² Available for software applications that support the function. Outputs sound at the volume input to the unit regardless of the **[USB Output Level]** setting.

Connections

Turn the unit off and disconnect the power cord before connecting other units.

Connect the power cord after all the connections are complete.

- Use the supplied power cord.
- Read the instruction manuals for the devices you're going to connect with the unit.

Connecting to the input terminals

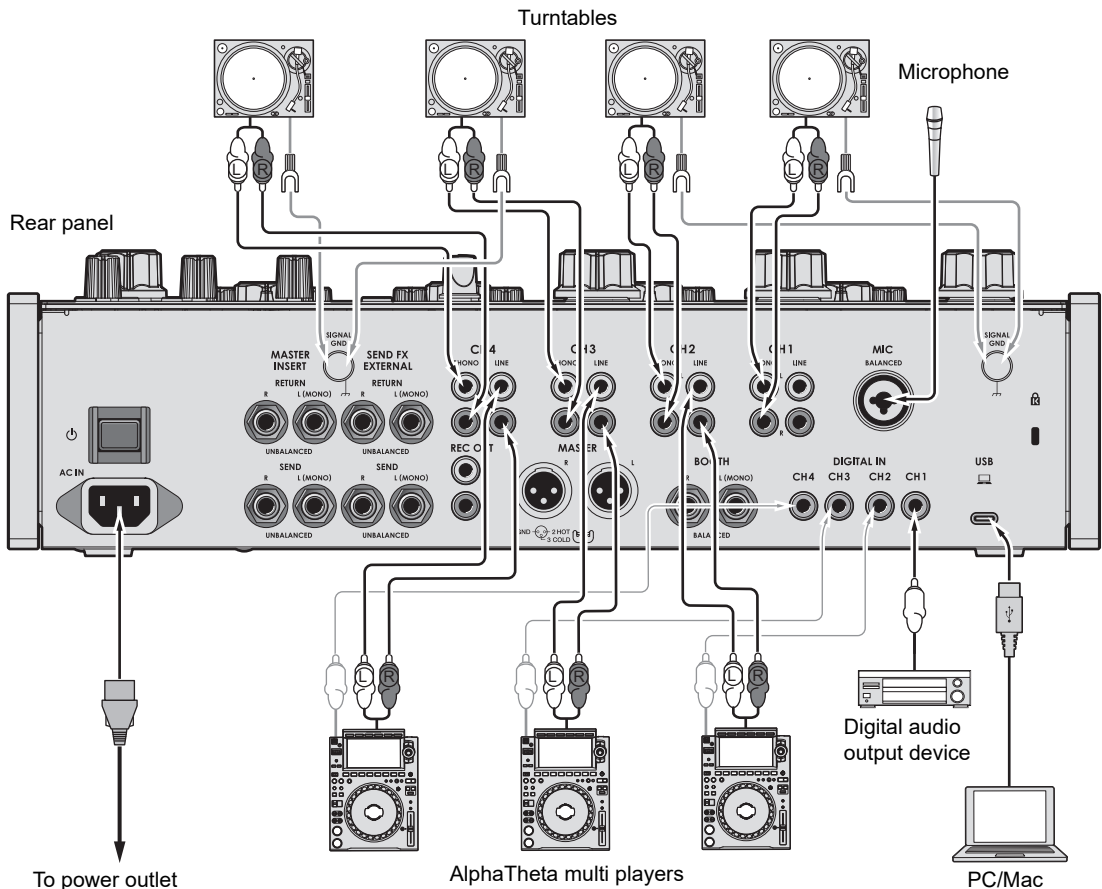

- It's recommended to connect this unit and a PC/Mac directly with a USB cable. When using a USB hub, use a product recommended by the manufacturer of your PC/Mac. We don't guarantee the operation of all USB hubs.
- To input or output your PC/Mac's audio to/from the unit, install the dedicated audio driver software and/or Setting Utility on your computer (page 13).

Connecting to the output terminals

Rear panel

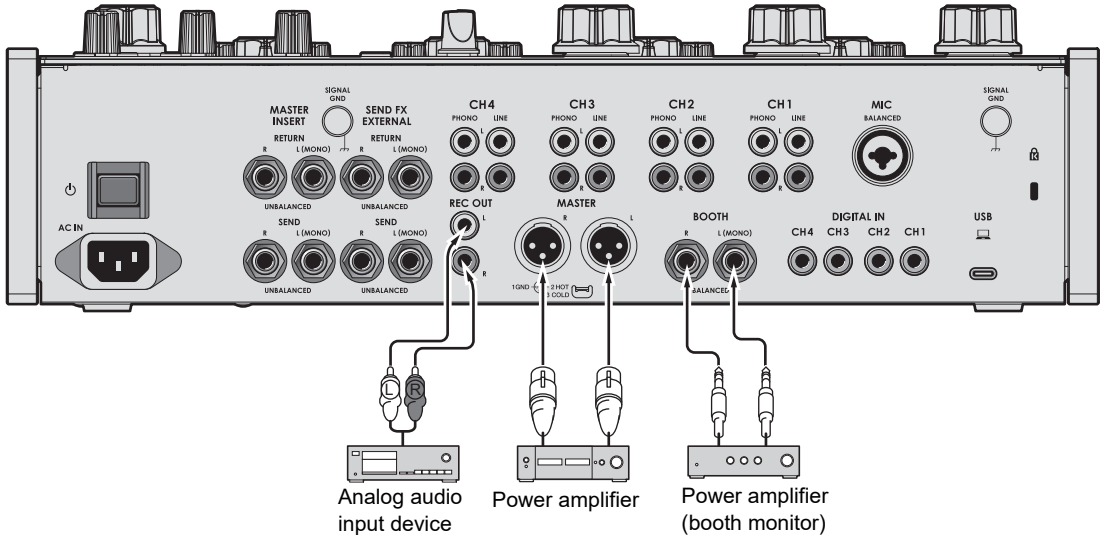

- Use the [**MASTER**] terminals for balanced output only. Connecting the terminals to unbalanced inputs (RCA, etc.) with an XLR-RCA conversion cable (conversion adapter), etc. results in unwanted noises and/or poor sound quality.
- Use the [**REC OUT**] terminals for unbalanced output (RCA, etc.).
- Use the [**BOOTH**] terminals for balanced output only. Connecting the terminals to unbalanced inputs results in unwanted noises and/or poor sound quality.
- Do not connect a power cord from another product or a terminal that can supply phantom power to the [**MASTER**] terminals.

Connecting to the terminals on the top panel

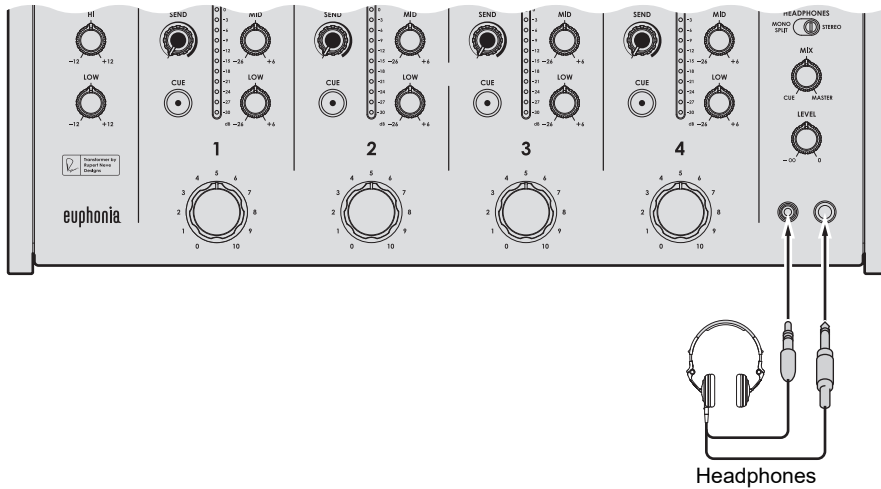

- Connect headphones to one of the terminals (jack or mini jack). If you use both terminals at the same time, the volume for headphones may decrease and/or the sound quality may deteriorate.

Connecting external effects units

For using SEND FX

To use external effects units with SEND FX, connect as follows.

- [SEND FX EXTERNAL SEND] terminals (output) → effects unit → [SEND FX EXTERNAL RETURN] terminals (input)
- Use effect units that can output effect sounds only.

Rear panel

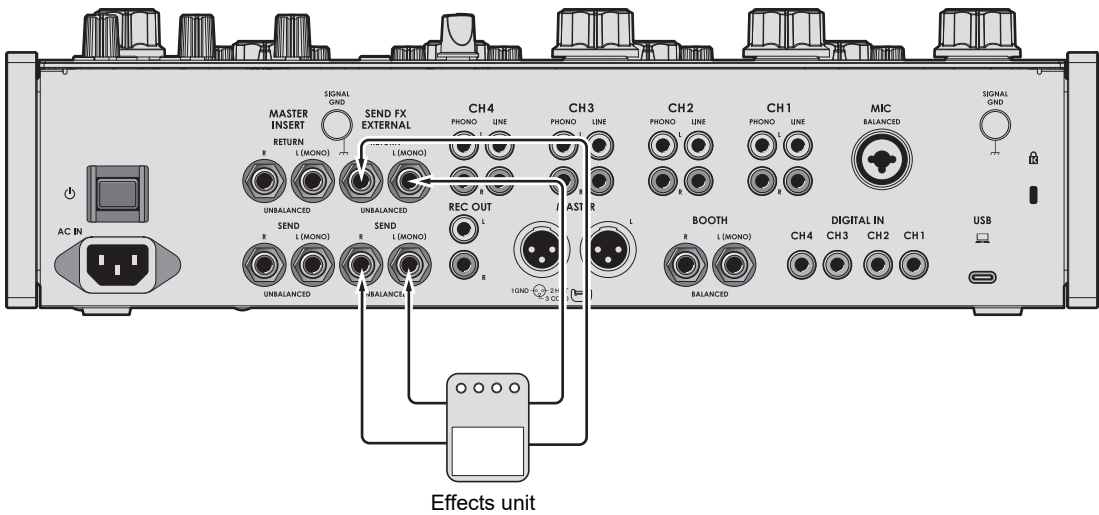

➡ Read more: SEND FX (page 38)

For using Master Insert

To use external effects units with Master Insert, connect as follows.

- [MASTER INSERT SEND] terminals (output) → effects unit → [MASTER INSERT RETURN] terminals (input)

Rear panel

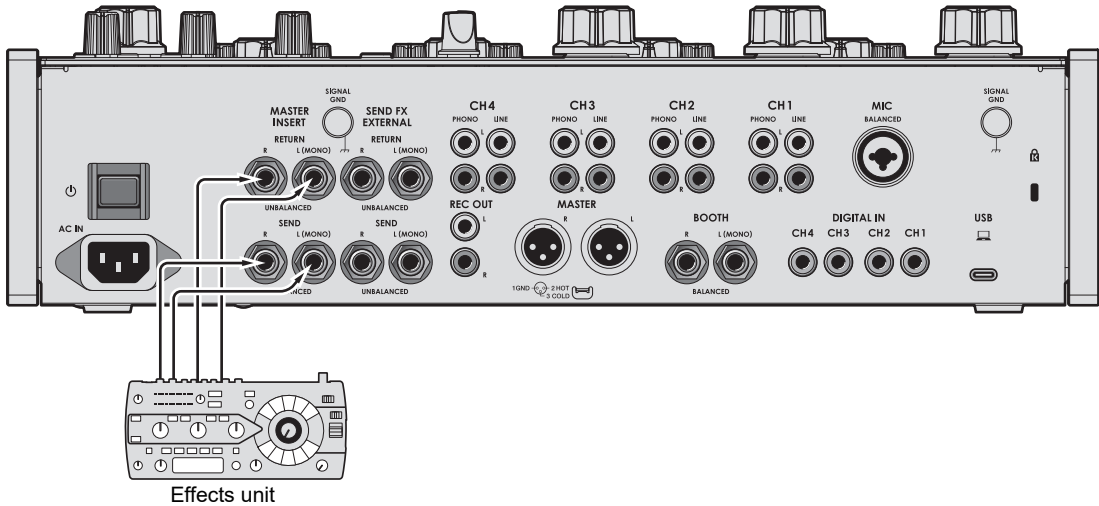

➡ Read more: Master Insert (page 44)

Audio output

Follow the procedures below to output and adjust sound.

- Outputting sound (page 28)
- Adjusting the sound of the channels (page 29)
- Adjusting the left/right sound balance (page 29)

➡ To output sound to the [BOOTH] terminals, see Using a booth monitor (page 35).

Channel section/master section

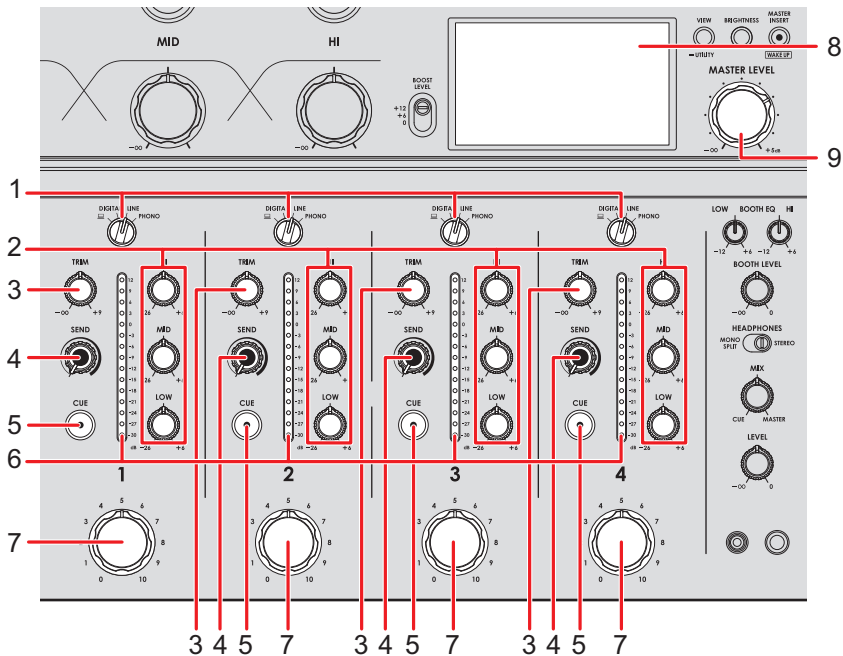

❖ Channel section

1. Input selector switch

Selects an input sound source.

- [🖥️]: Selects a PC/Mac connected to the [USB] port.
- [DIGITAL]: Selects a multi player, etc. connected to the [DIGITAL IN] terminal.
- [LINE]: Selects a multi player, etc. connected to the [LINE] terminals.

— **[PHONO]**: Selects a turntable connected to the **[PHONO]** terminals.

2. **EQ (HI, MID, LOW) knobs**

Adjusts the volume of each frequency band.

Each knob adjusts in the following range.

— **[HI]**: -26 dB to +6 dB

— **[MID]**: -26 dB to +6 dB

— **[LOW]**: -26 dB to +6 dB

3. **TRIM knob**

Adjusts the volume for the channel input sound.

4. **SEND knob** (page 38)

5. **CUE button** (page 34)

6. **Channel level indicator**

Displays the volume level before the sound passes through the channel rotary fader.

7. **Channel rotary fader**

Adjusts the volume for the channel output sound. Turning it clockwise increases the volume, and counterclockwise decreases the volume.

❖ **Master section**

8. **Screen** (page 10)

Displays the volume of the master sound on the right side of the screen.

9. **MASTER LEVEL knob**

Adjusts the volume for the master sound.

Outputting sound

Adjusting the channel input volume

- 1 Turn the input selector switch to select an input sound source.
- 2 Turn the [TRIM] knob to adjust the volume for the input sound.

The channel level indicator lights up when sound is input to the channel.

Adjusting the channel output volume

- 1 Turn the channel rotary fader to adjust the volume for the output sound.

Adjusting the master sound volume

- 1 Turn the [MASTER LEVEL] knob to adjust the volume for the master sound.

The peak level display changes when the master sound is output.

➔ Read more: Master Isolator (page 31).

Adjusting the sound of the channels

- 1 Turn the [EQ (HI, MID, LOW)] knobs to adjust the volume of each frequency band.

Adjusting the left/right sound balance

You can adjust the left/right balance for sounds output from the following terminals.

- [MASTER]
 - [REC OUT]
 - [BOOTH]
 - [USB]
 - PHONES
- You can adjust the left/right balance for sound output from the USB port only when [MIX(REC OUT with MIC)] or [MIX(REC OUT without MIC)] is selected for [Mixer Audio Output] in the Settings Utility (page 17).

- 1 Press and hold the [VIEW/UTILITY] button.

The [UTILITY] screen appears.

➡ Read more: Settings (page 46).

- 2 Select [BALANCE] and press the [MASTER INSERT/(WAKE UP)] button.

The [BALANCE] screen appears.

- 3 Press the [VIEW/UTILITY] or [BRIGHTNESS] button to adjust the left/right balance.

- Only the left channel sound of stereo audio is output when set to the [L] (leftmost) position, and only the right channel sound is output when set to the [R] (rightmost) position.

4 Press the [MASTER INSERT/(WAKE UP)] button.

- To cancel the setting, press the [TAP] button.

5 Press the [TAP] button.

The [UTILITY] screen closes.

Master Isolator

You can adjust the master sound.

Master Isolator section

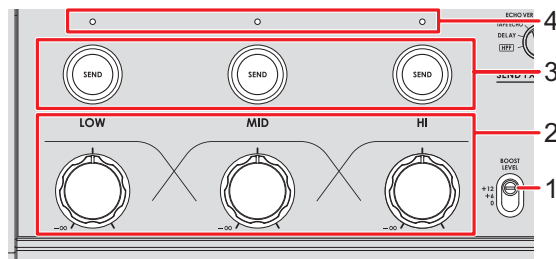

1. BOOST LEVEL switch

Sets the maximum volume that can be adjusted with the Master Isolator.

- +12: Can be adjusted up to +12 dB.
- +6: Can be adjusted up to +6 dB.
- 0: Can be adjusted up to 0 dB.

2. LOW, MID, HI knobs

Adjusts the volume of each frequency band.

Each knob adjusts in the following range.

- **[LOW]**: -∞ dB to the maximum level set with the **[BOOST LEVEL]** switch.
- **[MID]**: -∞ dB to the maximum level set with the **[BOOST LEVEL]** switch.
- **[HI]**: -∞ dB to the maximum level set with the **[BOOST LEVEL]** switch.

3. LOW, MID, HI SEND buttons

Selects the frequency band of the master sound to apply an effect to.

4. LOW, MID, HI SEND indicators

Lights up when an effect is applied to that frequency band.

➡ Read more: Routing effect sounds to the master output (page 40)

Adjusting the master sound

- 1 Set the [BOOST LEVEL] switch to select the maximum volume that can be adjusted with the Master Isolator
- 2 Turn the [LOW, MID, HI] knobs to adjust the volume of each frequency band.

Monitoring sound

Headphones section

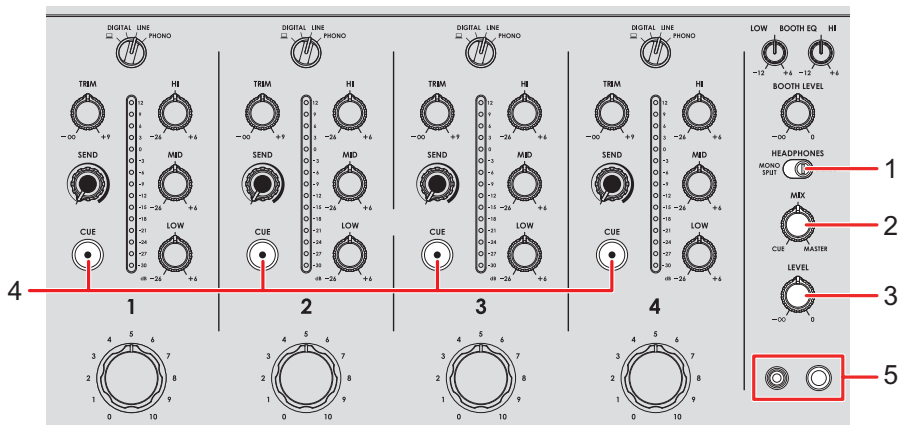

1. MONO SPLIT/STEREO switch

Sets the sound output method (MONO SPLIT or stereo) for the headphones.

- **[MONO SPLIT]**: Outputs the sound of the channel with the **[CUE]** button pressed to the left channel of your headphones, and the master sound to the right channel.
- **[STEREO]**: Outputs the stereo sound of the channel with the **[CUE]** button pressed and the master sound according to the **[MIX]** knob setting.

2. MIX knob

Adjusts the volume balance between the channel with the **[CUE]** button pressed and the master sound.

3. LEVEL knob

Adjusts the volume for the headphones monitor sound.

4. CUE button

Outputs sound to the PHONES terminals.

5. PHONES terminals

Connect headphones.

Monitoring with headphones

- 1 Connect headphones to one of the PHONES terminals.
- 2 Press a [CUE] button to select the channel you want to monitor.
- 3 Set the [MONO SPLIT/STEREO] switch to select the output sound (MONO SPLIT or stereo).
- 4 Turn the [MIX] knob to adjust the volume balance between the channel with the [CUE] button pressed and the master sound.
- 5 Turn the [LEVEL] knob to adjust the volume.

Booth section

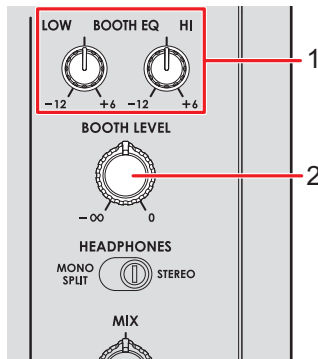

- 1. BOOTH EQ (LOW, HI) knobs**
Adjusts the volume of each frequency band.
Each knob adjusts in the following range.
 - [LOW]: -12 dB to +6 dB
 - [HI]: -12 dB to +6 dB
- 2. BOOTH LEVEL knob**
Adjusts the volume for the sound output to a booth monitor.

Using a booth monitor

- 1 Connect a booth monitor to the [BOOTH] terminals.**
 - ➡ Read more: [Connecting to the output terminals \(page 22\)](#)
- 2 Turn the [BOOTH LEVEL] knob to adjust the volume for the output sound.**
- 3 Turn the [BOOTH EQ (LOW, HI)] knobs to adjust the sound.**

Microphone

MIC section

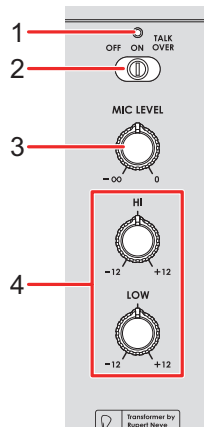

1. MIC indicator

Indicates the microphone sound output as follows.

- Off: The microphone is off.
- Lights up: The microphone is on.
- Blinks: The microphone talkover is on.

2. OFF, ON, TALKOVER selector switch

Sets the microphone sound output.

- **[OFF]**: Turns the microphone off.
- **[ON]**: Turns the microphone on.
- **[TALKOVER]**: Turns microphone talkover on. When sound is input to the microphone, the volume other than the microphone channel is lowered.

3. MIC LEVEL knob

Adjusts the volume of sound input from the **[MIC]** terminal.

4. EQ (HI, LOW) knobs

Adjusts the volume of sound input from the **[MIC]** terminal.

Each knob adjusts in the following range.

- **[HI]**: -12 dB to +12 dB
- **[LOW]**: -12 dB to +12 dB

Using a microphone

1 Connect a microphone to the [MIC] terminal.

➡ Read more: Connecting to the input terminals (page 21)

2 Slide the [OFF, ON, TALKOVER] selector switch to set the microphone sound output.

3 Turn the [MIC LEVEL] knob to adjust the microphone volume level.

- Note that turning the knob too far clockwise outputs the sound at a high volume.

4 Turn the [EQ (HI, LOW)] knobs to adjust the volume of each frequency band.

5 Speak into the microphone.

SEND FX

You can add the sound of the built-in effects or an external effects unit to the master sound.

SEND FX section

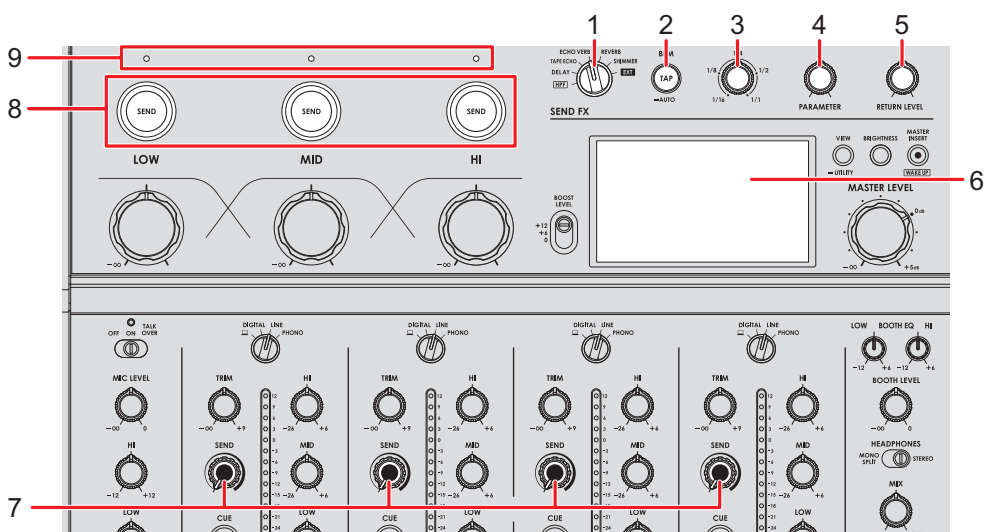

1. **SEND FX selector switch** (page 42)

2. **TAP button**

Selects the BPM measuring method (AUTO/TAP). The selected method is displayed on the screen.

— **AUTO**: Press and hold the button to turn on Auto BPM mode.

Automatically measures BPM of the input sound (measuring range: 70 to 180).

— **TAP**: Tap the button to manually set a BPM (page 41).

- It's automatically set to **[AUTO]** when the unit is turned on.

3. **TIME knob** (page 42)

4. **PARAMETER knob** (page 42)

5. **RETURN LEVEL knob** (page 42)

6. **Screen** (page 10)

7. **SEND knob** (page 42)

8. SEND (LOW, MID, HI) buttons

Select the frequency band ([LOW], [MID], [HI]) of the master sound to apply SEND FX to. The selected button lights up.

- The buttons don't light up when [HPF] is selected with the SEND FX selector switch.
- Press the lit [SEND] button to turn SEND off.

9. SEND (LOW, MID, HI) indicators

Lights up when the frequency band ([LOW], [MID], [HI]) of the master sound is sent.

- The frequency bands of the master sound are sent only when all the following conditions are met.
 - The [SEND] button is lit.
 - The corresponding [LOW], [MID], [HI] knobs for Master Isolator are set to the right of the center position.

➡ Connection when using an external effects unit: Connecting external effects units (page 24)

Applying High-Pass Filter (HPF) to the channel sound

HPF is applied to each channel when [HPF] is selected with the SEND FX selector switch.

➡ Read more: SEND FX types and settings (page 42)

1 Turn the SEND FX selector switch to select [HPF].

2 Turn a [SEND] knob to adjust the cut-off frequency.

- Turning all the way counterclockwise outputs the original sound.

3 Turn the [PARAMETER] knob to adjust the resonance.

- The following buttons and knobs are disabled when [HPF] is selected with the SEND FX selector switch.
 - [SEND (LOW, MID, HI)] buttons
 - TIME knob
 - [RETURN LEVEL] knob

Routing effect sounds to the master output

You can route the sound of one of the built-in effects or an external effects unit to the master output.

Effects can be applied from the channel sound or master sound.

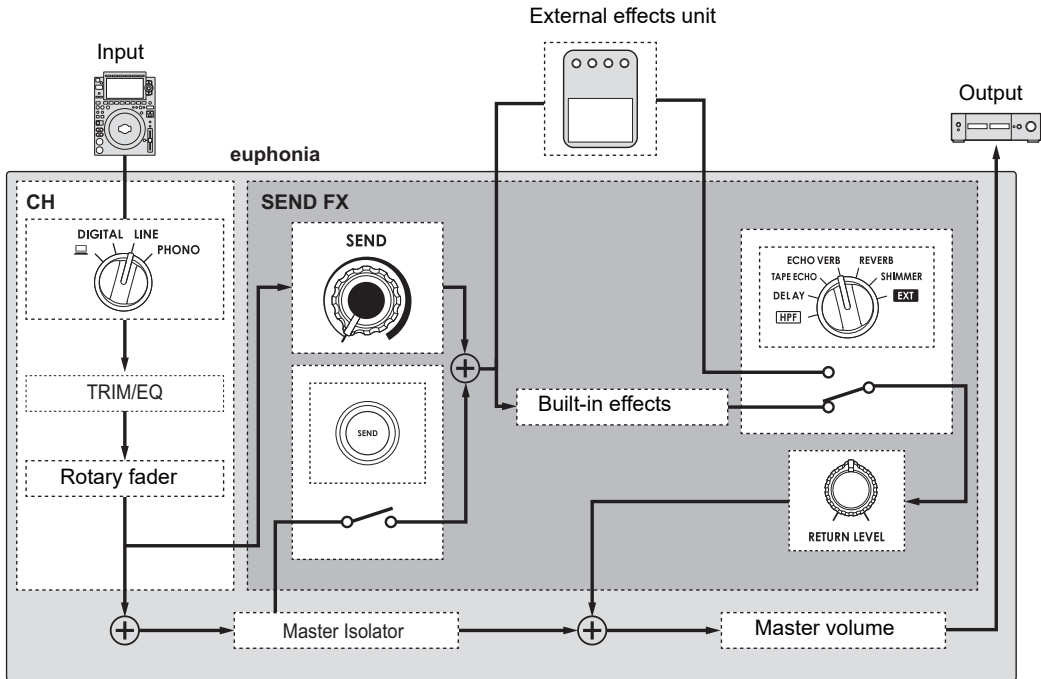

➤ Read more: SEND FX types and settings (page 42)

- 1 Turn the **SEND FX** selector switch to select an effect.
 - If you're using an external effects unit, skip to step 5.
- 2 Press the **[TAP]** button to select a BPM measuring mode.
- 3 Turn the **TIME** knob to adjust the time parameter for the effect.
- 4 Turn the **[PARAMETER]** knob to adjust the quantitative parameter for the effect.
- 5 Turn the **[RETURN LEVEL]** knob to adjust the effect volume.

6 Adjust the SEND level as follows.

- Channel sound: Turn the [SEND] knob.
- Master sound: Press the [SEND] button and turn the [LOW], [MID], [HI] knobs for Master Isolator to the right from the center position.

Setting the BPM manually

1 Tap the [TAP] button more than twice in time with the beat of the music.

BPM is set according to the average time between taps.

- BPM can be set between 40 and 300.

SEND FX types and settings

You can adjust the following settings with the knobs.

- The selected effect is displayed on the screen.
- Built-in effects and external effects can't be selected at the same time.

Effect/operation

Description

Built-in effects

HPF ¹	Applies High-Pass Filter to the channel sound.
• SEND:	Cut-off frequency for filter
• PARAMETER:	Resonance
DELAY	Adds clear delay sound.
• SEND:	SEND level
• TIME ² :	Delay time with respect to 1 beat of the BPM (beat fraction): 1/16 to 1 beat
• PARAMETER:	Feedback
TAPE ECHO	Adds delay sound with fluctuation and saturation.
• SEND:	SEND level
• TIME ² :	Delay time with respect to 1 beat of the BPM (beat fraction): 1/16 to 1 beat
• PARAMETER:	Feedback

Effect/operation	Description
ECHO VERB	Adds clear delay sound and reverberation.
• SEND:	SEND level
• TIME ^[2] :	Delay time and reverberation with respect to 1 beat of the BPM (beat fraction): 1/16 to 1 beat
• PARAMETER:	Balance between delay sound and reverberation
REVERB	Adds reverberation.
• SEND:	SEND level
• TIME:	Reverberation time
• PARAMETER:	Tone
SHIMMER	Adds a sparkling reverberation.
• SEND:	SEND level
• TIME:	Reverberation time
• PARAMETER:	Sparkling effect
External effects	
EXT ^[3]	Adds an effect sound from an external effects unit that's connected to the [SEND FX EXTERNAL SEND] and [SEND FX EXTERNAL RETURN] terminals.
• SEND:	SEND level

[1] The TIME and **[RETURN LEVEL]** knobs are disabled. The effect can't be applied to the master sound.

[2] If you adjust it to the beat fraction printed around the knob, you'll feel a click.

[3] The TIME and **[PARAMETER]** knobs are disabled.

Master Insert

You can switch the effect sounds of an external effects unit and the master sound.

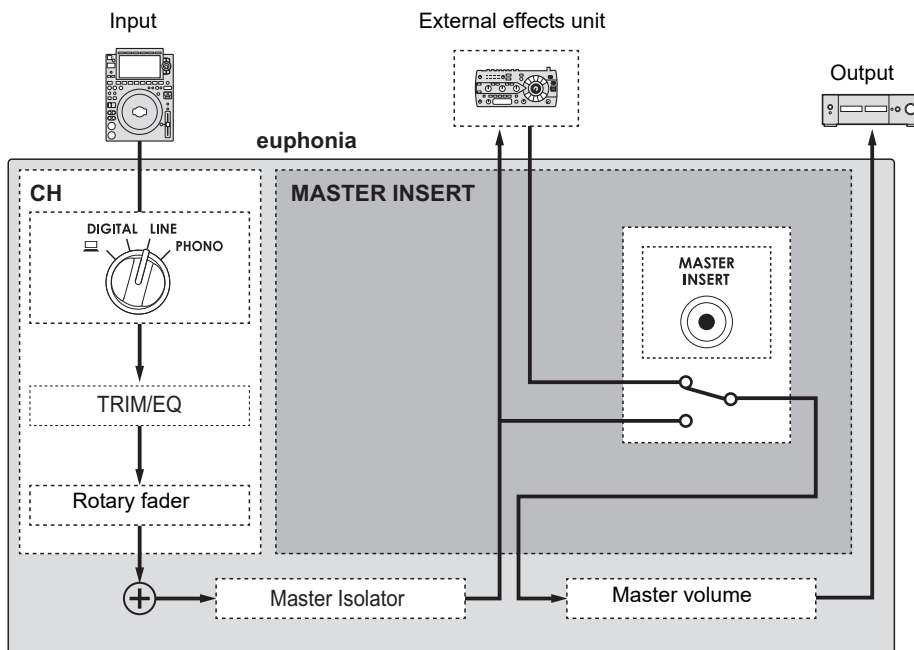

➡ Read more: Connecting external effects units (page 24).

Using Master Insert

- 1 Connect an external effects unit to the [MASTER INSERT SEND] and [MASTER INSERT RETURN] terminals.
- 2 Press the [MASTER INSERT/(WAKE UP)] button to turn Master Insert on.
 - Press the [MASTER INSERT/(WAKE UP)] button again to turn Master Insert off.
 - Master Insert is turned off when an external effects unit isn't connected to the unit.
 - You can't turn Master Insert on and off when the [UTILITY] screen is displayed (page 48).
 - Check the output volume in the connected external effects unit before turning Master Insert on or off.

USB/MIDI

If you have a PC/Mac with MIDI software installed and connect it to the unit via a USB cable, you can control DJ software via the unit.

- For details on the unit's MIDI messages, visit the URL below.

alphatheta.com/support/

- MIDI timing clock is always sent.

USB/MIDI section

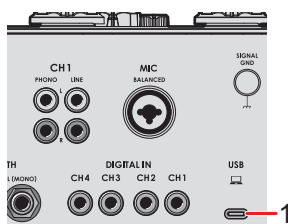

1. (USB) port (page 21)

- To input or output your PC/Mac's audio to/from the unit, install the dedicated software on your computer (page 13). If the dedicated software isn't installed on the PC/Mac, a message is displayed on the screen of the unit.

Controlling MIDI software

- Install MIDI software and configure the audio and MIDI settings on your PC/Mac beforehand.

1 Connect your PC/Mac to the unit.

2 Launch the MIDI software.

Settings

You can change the unit's settings in the Utility settings.

UTILITY screen

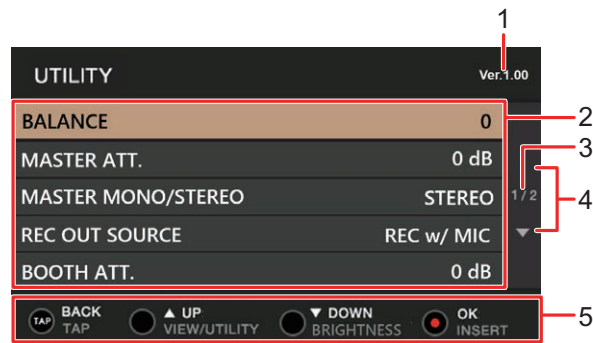

1. **Firmware version**
2. **Setting items** (page 48)
3. **Page number**
Indicates the current page number/total number of pages.
4. 
Press the [VIEW/UTILITY] or [BRIGHTNESS] button to display the next or previous page.
5. **Operation buttons display for the screen**

Changing the settings

1 Press and hold the [VIEW/UTILITY] button.

The [UTILITY] screen appears.

2 Press the [VIEW/UTILITY] or [BRIGHTNESS] button to select a setting item, and press the [MASTER INSERT/(WAKE UP)] button.

➡ Read more: Utility settings (page 48)

3 Change the setting.

- To cancel the setting, press the [TAP] button.

4 Press the [TAP] button.

The [UTILITY] screen closes.

Utility settings

*: Factory setting

Setting item	Description
BALANCE	<p>Sets the output balance.</p> <ul style="list-style-type: none"> Setting values: L128 to 0* to R127
MASTER ATT.	<p>Sets the attenuation level for the master sound output from the [MASTER] and [REC OUT] terminals.</p> <ul style="list-style-type: none"> Setting values: -12dB, -9dB, -6dB, -3dB, 0dB*
MASTER MONO/STEREO	<p>Sets the output method (mono/stereo) for the master sound output from the [MASTER] and [REC OUT] terminals.</p> <ul style="list-style-type: none"> Setting values: MONO, STEREO*
REC OUT SOURCE	<p>Sets the sound output from the [REC OUT] terminals.</p> <ul style="list-style-type: none"> Setting values: REC w/ MIC*, REC w/o MIC, MASTER [REC w/ MIC] outputs the master sound and microphone sound which haven't been adjusted with the [MASTER LEVEL] knob. [REC w/o MIC] outputs the master sound before it's affected by the [MASTER LEVEL] knob. [MASTER] outputs the same sound output from the [MASTER] terminals.
BOOTH ATT.	<p>Sets the attenuation level for the sound output from the [BOOTH] terminals.</p> <ul style="list-style-type: none"> Setting values: -12dB, -9dB, -6dB, -3dB, 0dB*
BOOTH MONO/STEREO	<p>Sets the output method (mono/stereo) for the sound output from the [BOOTH] terminals.</p> <ul style="list-style-type: none"> Setting values: MONO, STEREO*

Setting item	Description
BOOTH MUTE WHEN MIC ON	<p>Sets whether to mute the sound output from the [BOOTH] terminals when the microphone is turned on.</p> <ul style="list-style-type: none"> Setting values: OFF*, ON
MIC TO BOOTH ATT.	<p>Sets the volume for the microphone sound that's input to the sound output from the [BOOTH] terminals.</p> <ul style="list-style-type: none"> Setting values: -∞, -18dB, -15dB, -12dB, -9dB, -6dB, -3dB, 0dB*
POWER MANAGEMENT	<p>Sets the Power Management function (page 49).</p> <ul style="list-style-type: none"> Setting values: OFF, ON*

Power Management

When **[POWER MANAGEMENT]** is set to **[ON]**, the unit automatically enters Off mode after 20 minutes of inactivity if no audio signal is input to the unit. The **[MASTER INSERT/(WAKE UP)]** button lights up in Off mode.

Press the **[MASTER INSERT/(WAKE UP)]** button to exit Off mode.

- The factory setting is **[ON]**.
- Set **[POWER MANAGEMENT]** to **[OFF]** if you don't need to use the Power Management function.
- Power consumption may increase when **[POWER MANAGEMENT]** is set to **[OFF]**.

Restoring the factory settings

- 1 While pressing the [MASTER INSERT/(WAKE UP)] button, press the [⏻] button.

The [FACTORY RESET] screen appears.



- 2 Press the [VIEW/UTILITY] or [BRIGHTNESS] button to select [YES], and press the [MASTER INSERT/(WAKE UP)] button.
- 3 Press the [⏻] button to turn the unit off.

The factory settings are restored.

Specifications

General

Power requirements.....	AC 110 V – 240 V, 50 Hz/60 Hz
Power consumption	43 W
Power consumption (off).....	0.2 W
Main unit weight.....	9.5 kg/20.94 lbs.
Max. external dimensions(W × D × H)	429.2 × 331.0 × 119.9 mm/16.90" × 13.03" × 4.72"
Tolerable operating temperature.....	+5 °C – +35 °C (+41 °F – +95 °F)
Tolerable operating humidity.....	5 % – 85 % (no condensation)

Audio section

Sampling rate.....	96 kHz
MASTER, BOOTH, SEND (MASTER INSERT) D/A converter.....	32bit
CH input A/D converter	32bit
Other A/D and D/A converters.....	24bit
Frequency characteristic	
LINE	20 Hz – 40 kHz
S/N ratio (rated output, A-WEIGHTED)	
USB, DIGITAL IN.....	107 dB
PHONO	88 dB
LINE	105 dB
MIC.....	79 dB
Standard input level/Input impedance	
PHONO	-52 dBu/47 kΩ
LINE	-12 dBu/47 kΩ
MIC.....	-57 dBu/ 3.5 kΩ
RETURN	-12 dBu/47 kΩ
Max. input level	
PHONO	-17.8 dBu
LINE	+15 dBu
MIC.....	+2 dBu
RETURN	+12 dBu
Standard output level/Load impedance/Output impedance	
MASTER	+6 dBu/10 kΩ/360 Ω
REC OUT	-8 dBu/10 kΩ/700 Ω

Specifications

BOOTH	+6 dBu/10 k Ω /360 Ω
SEND (EXTERNAL).....	-9 dBu/10 k Ω /700 Ω
SEND (MASTER INSERT).....	-12 dBu/10 k Ω /700 Ω
PHONES	+8 dBu/32 Ω /1 Ω or lower
Rated output level/Load impedance	
MASTER	+25 dBu/10 k Ω
BOOTH	+25 dBu/10 k Ω
Crosstalk	
LINE	82 dB
Channel equalizer characteristic	
HI.....	-26 dB – +6 dB (20 kHz)
MID.....	-26 dB – +6 dB (1 kHz)
LOW	-26 dB – +6 dB (20 Hz)
Microphone equalizer characteristic	
HI.....	-12 dB – +12 dB (10 kHz)
LOW	-12 dB – +12 dB (100 Hz)
BOOTH equalizer characteristic	
HI.....	-12 dB – +6 dB (10 kHz)
LOW	-12 dB – +6 dB (100 Hz)
MASTER ISOLATOR characteristic	
Slope	18 dB/oct
Cut/Boost	OFF – X dB (X = 0, +6, +12)
Crossover Freq.	250 Hz/3.5 kHz
Input/Output terminals	
PHONO input terminal	
RCA pin jacks.....	4 sets
LINE input terminal	
RCA pin jacks.....	4 sets
MIC input terminal	
XLR connector & 1/4" TRS jack	1 set
RETURN input terminal	
1/4" TS jack	2 sets
DIGITAL IN coaxial input terminal	
RCA pin jacks.....	4 sets
MASTER output terminal	
XLR connector	1 set
BOOTH output terminal	
1/4" TRS jack	1 set

Specifications

REC OUT output terminal	
RCA pin jacks	1 set
SEND output terminal	
1/4" TS jack	2 sets
PHONES output terminal	
1/4" stereo jack.....	1 set
3.5 mm stereo mini jack	1 set
USB terminal	
USB Type-C	1 set

The specifications and design of this product are subject to change without notice.

Block diagram

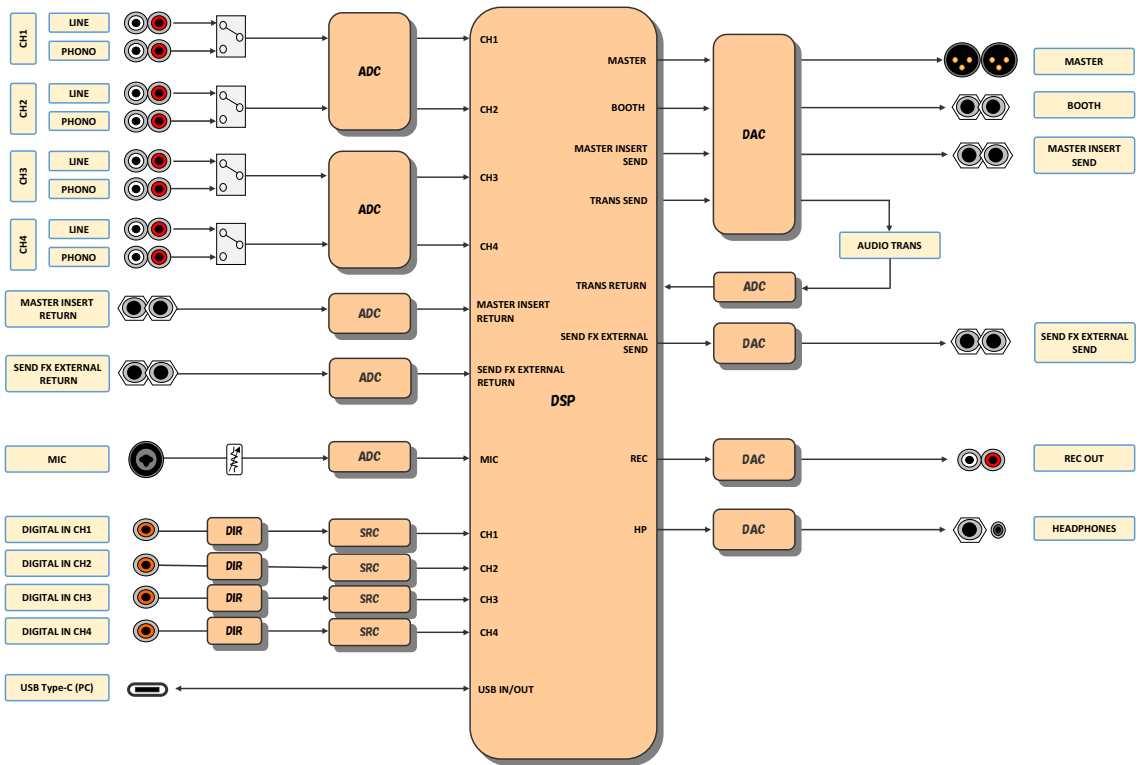

Specifications

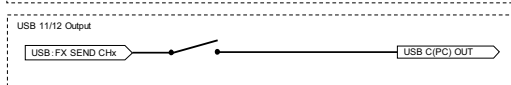
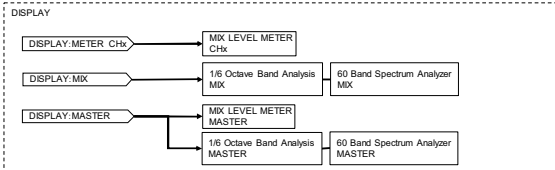
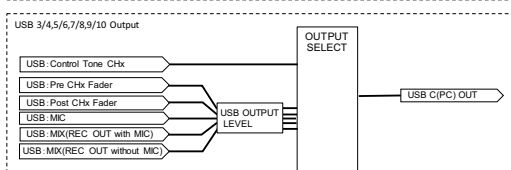
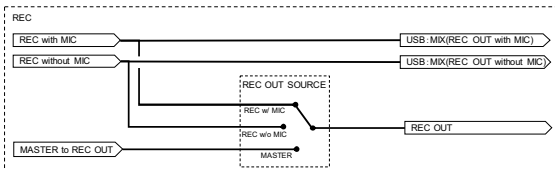
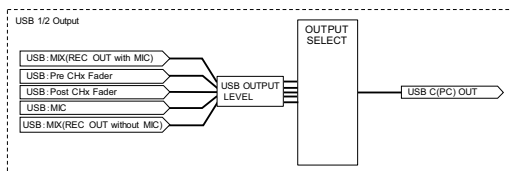
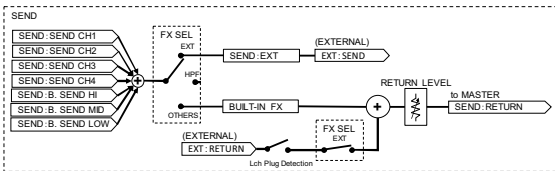
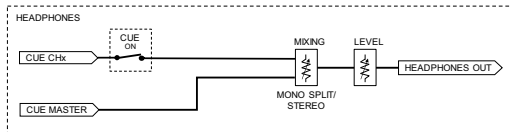
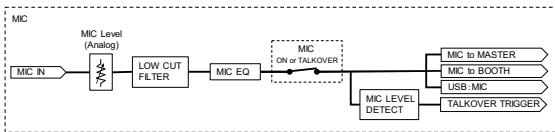
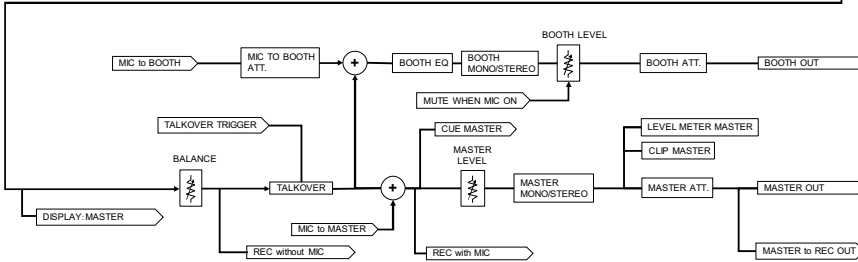
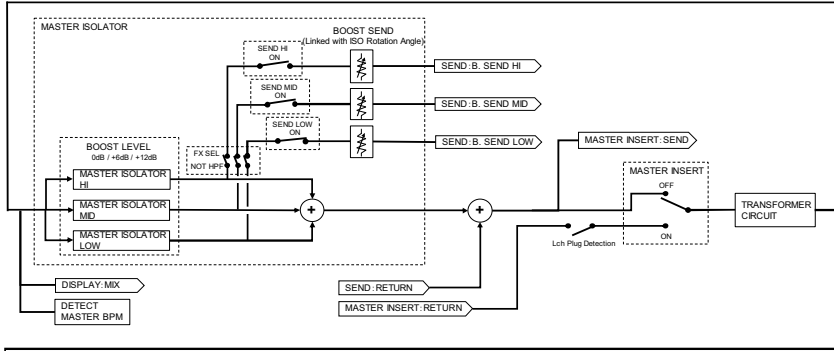
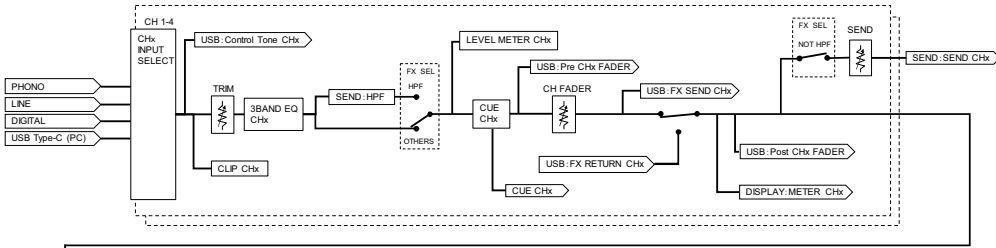

Additional information

Troubleshooting

If you think something is wrong with the unit, check the information below and refer to the [FAQ] for the EUPHONIA at the URL below.

alphatheta.com/support/

- Inspect devices connected with the unit.
- The unit may restore proper operation after you turn it off and on.

If the problems continue, read the Precautions for Use and consult an authorized service company or your dealer.

Power

❖ The unit doesn't turn on.

- Check if the power cord is connected properly.
- Press the [⏻] button on the rear of the unit to turn it on.

Audio output

❖ The unit doesn't output sound or the volume is low.

- Check if the input selector switch is set properly.
- Check all cables are connected properly.
- Wipe any dust or dirt off the terminals and plugs before connecting them.
- Change the [MASTER ATT.] setting in the Utility settings.

❖ Sound is distorted.

For the master sound:

- Adjust the [MASTER LEVEL] knob so the screen shows the peak level around [0.0 dB].
- Set [MASTER ATT.] to a setting between [-3dB] and [-12dB] in the Utility settings.

For the channel input sound:

- Adjust the [TRIM] knob so [+12] dB of the channel level indicator doesn't light up.

Effects

❖ **SEND FX doesn't work.**

- Check if the [SEND] knob is set properly.
- Make sure any external effects unit is connected to the [SEND FX EXTERNAL SEND] and [SEND FX EXTERNAL RETURN] terminals properly.
- Make sure the SEND FX selector switch isn't set to [HPF] before using the [SEND] button.

❖ **SEND FX isn't input to the master sound.**

- Check if the [RETURN LEVEL] knob is set properly.

❖ **There's no clicking feeling when using the TIME knob.**

- You won't get a clicking feeling if the SEND FX selector switch isn't set to [DELAY], [TAPE ECHO], or [ECHO VERB].

❖ **Master Insert doesn't work.**

- Make sure any external effects unit is connected to the [MASTER INSERT SEND] and [MASTER INSERT RETURN] terminals properly.
- Make sure the volume for the external effects unit is set properly.
- Check if the [MASTER INSERT/(WAKE UP)] button blinks.

❖ **Sound from an external effects unit is distorted.**

- Make sure the volume for the external effects unit is set properly.

❖ **The tempo (BPM) of a track can't be measured or the measured tempo is wrong.**

- Adjust the [TRIM] knob so [+12] dB of the channel level indicator doesn't light up.
- To measure the BPM automatically, make sure sound is being output from the master.
- Tempo (BPM) can't be measured for some tracks. Use the [TAP] button to manually set the tempo for those tracks.

❖ **The measured tempo (BPM) differs from the value shown in the track's information.**

- The values don't match when BPM measuring methods are different.

Connections

❖ **[No dedicated audio driver and/or Setting Utility installed.] is displayed when the unit is connected to a PC/Mac.**

- Install the dedicated software on the PC/Mac. If the software is already installed, reinstall it.

❖ **Sound from a connected PC/Mac isn't outputting from the unit.**

- Make sure the PC/Mac is connected properly.
- We recommend you connect this unit and a PC/Mac directly with a USB cable.
- When using a USB hub, use a product recommended by the manufacturer of your PC/Mac.
- We don't guarantee the operation of all USB hubs.
- Select this unit in the audio output device settings in the computer's software. For details, refer to the instruction manual for the software.
- Set the input selector switch to [🖥️].

❖ **Sound is distorted when a turntable is connected to the [PHONO] terminals on the unit or the status of the channel level indicator doesn't change when turning the [TRIM] knob.**

- Check if the connected turntable has a built-in phono equalizer (if it does, connect the turntable to the [LINE] terminals).
- If the turntable has a PHONO/LINE selector switch, set it to PHONO.
- If the audio interface for PC/Mac, which is connected between the unit and the turntable, is a line-level device, connect the interface to the [LINE] terminals.

LCD display

- Small black or shining points may appear on the LCD display. This is a phenomenon inherent to LCD displays and not a malfunction.
- When using the unit in cold places, the LCD display may be dark for a while after the power is turned on. Normal brightness will restore after a while.
- When the LCD display is exposed to direct sunlight, the light will reflect off it, making it difficult to see. Block the direct sunlight to improve visibility of the display.

Cleaning

Wipe with a dry soft cloth.

- Do not use organic solvents, acids, or alkalis for cleaning.

Trademarks and registered trademarks

- rekordbox™ is a trademark or registered trademark of AlphaTheta Corporation.
- Mac, macOS and Finder are trademarks of Apple Inc., registered in the U.S. and other countries and regions.
- Windows is a trademark or registered trademark of Microsoft Corporation in the U.S. and other countries.
- ASIO is a trademark or registered trademark of Steinberg Media Technologies GmbH.
- R logo is a registered trademark of Rupert Neve Designs, LLC.

Other product, technology and company names, etc. mentioned herein are trademarks or registered trademarks of their respective owners.

About using MP3 files

This product has been licensed for nonprofit use. This product has not been licensed for commercial purposes (for profit-making use), such as broadcasting (terrestrial, satellite, cable or other types of broadcasting), streaming on the Internet, Intranet (a corporate network) or other types of networks or distributing of electronic information (online digital music distribution service). You need to acquire the corresponding licenses for such uses. For details, see <http://www.mp3licensing.com>.

Software license notice

The licenses for the open source software used on this product are shown below. For accuracy purposes, here we have included the original texts (in English).

Copyright © 2010 Texas Instruments Incorporated - <http://www.ti.com/>

Redistribution and use in source and binary forms, with or without modification, are permitted provided that the following conditions are met:

Redistributions of source code must retain the above copyright notice, this list of conditions and the following disclaimer.

Redistributions in binary form must reproduce the above copyright notice, this list of conditions and the following disclaimer in the documentation and/or other materials provided with the distribution.

Neither the name of Texas Instruments Incorporated nor the names of its contributors may be used to endorse or promote products derived from this software without specific prior written permission.

THIS SOFTWARE IS PROVIDED BY THE COPYRIGHT HOLDERS AND CONTRIBUTORS «AS IS» AND ANY EXPRESS OR IMPLIED WARRANTIES, INCLUDING, BUT NOT LIMITED TO, THE IMPLIED WARRANTIES OF MERCHANTABILITY AND FITNESS FOR A PARTICULAR PURPOSE ARE DISCLAIMED. IN NO EVENT SHALL THE COPYRIGHT OWNER OR CONTRIBUTORS BE LIABLE FOR ANY DIRECT, INDIRECT, INCIDENTAL, SPECIAL, EXEMPLARY, OR CONSEQUENTIAL DAMAGES (INCLUDING, BUT NOT LIMITED TO, PROCUREMENT OF SUBSTITUTE GOODS OR SERVICES; LOSS OF USE, DATA, OR PROFITS; OR BUSINESS INTERRUPTION) HOWEVER CAUSED AND ON ANY THEORY OF LIABILITY, WHETHER IN CONTRACT, STRICT LIABILITY, OR TORT (INCLUDING NEGLIGENCE OR OTHERWISE) ARISING IN ANY WAY OUT OF THE USE OF THIS SOFTWARE, EVEN IF ADVISED OF THE POSSIBILITY OF SUCH DAMAGE.

Apache

Copyright (c) 2009-2019 ARM Limited. All rights reserved.

SPDX-License-Identifier: Apache-2.0

Licensed under the Apache License, Version 2.0 (the License); you may not use this file except in compliance with the License.

You may obtain a copy of the License at

www.apache.org/licenses/LICENSE-2.0

Unless required by applicable law or agreed to in writing, software distributed under the License is distributed on an AS IS BASIS, WITHOUT WARRANTIES OR CONDITIONS OF ANY KIND, either express or implied.

See the License for the specific language governing permissions and limitations under the License.

BSD

The BSD-3-Clause License

Copyright (c) 2015, Freescale Semiconductor, Inc.

Copyright 2016-2020 NXP

All rights reserved.

Redistribution and use in source and binary forms, with or without modification, are permitted provided that the following conditions are met:

1. Redistributions of source code must retain the above copyright notice, this list of conditions and the following disclaimer.
2. Redistributions in binary form must reproduce the above copyright notice, this list of conditions and the following disclaimer in the documentation and/or other materials provided with the distribution.
3. Neither the name of the copyright holder nor the names of its contributors may be used to endorse or promote products derived from this software without specific prior written permission.

THIS SOFTWARE IS PROVIDED BY THE COPYRIGHT HOLDERS AND CONTRIBUTORS "AS IS" AND ANY EXPRESS OR IMPLIED WARRANTIES, INCLUDING, BUT NOT LIMITED TO, THE IMPLIED WARRANTIES OF MERCHANTABILITY AND FITNESS FOR A PARTICULAR PURPOSE ARE DISCLAIMED. IN NO EVENT SHALL THE COPYRIGHT HOLDER OR CONTRIBUTORS BE LIABLE FOR ANY DIRECT, INDIRECT, INCIDENTAL, SPECIAL, EXEMPLARY, OR CONSEQUENTIAL DAMAGES (INCLUDING, BUT NOT LIMITED TO, PROCUREMENT OF SUBSTITUTE GOODS OR SERVICES; LOSS OF USE, DATA, OR PROFITS; OR BUSINESS INTERRUPTION) HOWEVER CAUSED AND ON ANY THEORY OF LIABILITY, WHETHER IN CONTRACT, STRICT LIABILITY, OR TORT (INCLUDING NEGLIGENCE OR OTHERWISE) ARISING IN ANY WAY OUT OF THE USE OF THIS SOFTWARE, EVEN IF ADVISED OF THE POSSIBILITY OF SUCH DAMAGE.

The curl license

COPYRIGHT AND PERMISSION NOTICE

Copyright (c) 1996 - 2023, Daniel Stenberg, daniel@haxx.se, and many contributors, see the THANKS file.

All rights reserved.

Permission to use, copy, modify, and distribute this software for any purpose with or without fee is hereby granted, provided that the above copyright notice and this permission notice appear in all copies.

THE SOFTWARE IS PROVIDED "AS IS", WITHOUT WARRANTY OF ANY KIND, EXPRESS OR IMPLIED, INCLUDING BUT NOT LIMITED TO THE WARRANTIES OF MERCHANTABILITY, FITNESS FOR A PARTICULAR PURPOSE AND NONINFRINGEMENT OF THIRD PARTY RIGHTS. IN NO EVENT SHALL THE AUTHORS OR COPYRIGHT HOLDERS BE LIABLE FOR ANY CLAIM, DAMAGES OR OTHER LIABILITY, WHETHER IN AN ACTION OF CONTRACT, TORT OR OTHERWISE, ARISING FROM, OUT OF OR IN CONNECTION WITH THE SOFTWARE OR THE USE OR OTHER DEALINGS IN THE SOFTWARE.

Except as contained in this notice, the name of a copyright holder shall not be used in advertising or otherwise to promote the sale, use or other dealings in this Software without prior written authorization of the copyright holder.

=====
libc++ License
=====

The libc++ library is dual licensed under both the University of Illinois "BSD-Like" license and the MIT license.

As a user of this code you may choose to use it under either license. As a contributor, you agree to allow your code to be used under both.

Full text of the relevant licenses is included below.

=====

University of Illinois/NCSA
Open Source License

Copyright (c) 2009-2017 by the contributors listed in CREDITS.TXT

All rights reserved.

Developed by:

LLVM Team

University of Illinois at Urbana-Champaign

<http://llvm.org>

Permission is hereby granted, free of charge, to any person obtaining a copy of this software and associated documentation files (the "Software"), to deal with the Software without restriction, including without limitation the rights to use, copy, modify, merge, publish, distribute, sublicense, and/or sell copies of the Software, and to permit persons to whom the Software is furnished to do so, subject to the following conditions:

- * Redistributions of source code must retain the above copyright notice, this list of conditions and the following disclaimers.
- * Redistributions in binary form must reproduce the above copyright notice, this list of conditions and the following disclaimers in the documentation and/or other materials provided with the distribution.
- * Neither the names of the LLVM Team, University of Illinois at Urbana-Champaign, nor the names of its contributors may be used to endorse or promote products derived from this Software without specific prior written permission.

THE SOFTWARE IS PROVIDED "AS IS", WITHOUT WARRANTY OF ANY KIND, EXPRESS OR IMPLIED, INCLUDING BUT NOT LIMITED TO THE WARRANTIES OF MERCHANTABILITY, FITNESS FOR A PARTICULAR PURPOSE AND NONINFRINGEMENT. IN NO EVENT SHALL THE CONTRIBUTORS OR COPYRIGHT HOLDERS BE LIABLE FOR ANY CLAIM, DAMAGES OR OTHER LIABILITY, WHETHER IN AN ACTION OF CONTRACT, TORT OR OTHERWISE, ARISING FROM, OUT OF OR IN CONNECTION WITH THE SOFTWARE OR THE USE OR OTHER DEALINGS WITH THE SOFTWARE.

=====

Copyright (c) 2009-2014 by the contributors listed in CREDITS.TXT

Permission is hereby granted, free of charge, to any person obtaining a copy of this software and associated documentation files (the "Software"), to deal in the Software without restriction, including without limitation the rights to use, copy, modify, merge, publish, distribute, sublicense, and/or sell copies of the Software, and to permit persons to whom the Software is furnished to do so, subject to the following conditions:

The above copyright notice and this permission notice shall be included in all copies or substantial portions of the Software.

THE SOFTWARE IS PROVIDED "AS IS", WITHOUT WARRANTY OF ANY KIND, EXPRESS OR IMPLIED, INCLUDING BUT NOT LIMITED TO THE WARRANTIES OF MERCHANTABILITY, FITNESS FOR A PARTICULAR PURPOSE AND NONINFRINGEMENT. IN NO EVENT SHALL THE AUTHORS OR COPYRIGHT HOLDERS BE LIABLE FOR ANY CLAIM, DAMAGES OR OTHER LIABILITY, WHETHER IN AN ACTION OF CONTRACT, TORT OR OTHERWISE, ARISING FROM, OUT OF OR IN CONNECTION WITH THE SOFTWARE OR THE USE OR OTHER DEALINGS IN THE SOFTWARE.

Cautions on copyrights

Recordings you have made are for your personal enjoyment and according to copyright laws may not be used without the consent of the copyright holder.

- Music recorded from CDs, etc., is protected by the copyright laws of individual countries and by international treaties. It is the full responsibility of the person who has recorded the music to ensure that it is used legally.
- When handling music downloaded from the Internet, etc., it is the full responsibility of the person who has downloaded the music to ensure that it is used in accordance with the contract concluded with the download site.

The specifications and design of this product are subject to change without notice.

© 2024 AlphaTheta Corporation. All rights reserved.

<DRI1891-A>